



**Ultrasound Solutions**

# **VIGILANT** Powered by SDT **USER MANUAL**

Version 4 – 2022

© SDT International. All rights reserved. Specifications are subject to change without notice.

## Table of contents

<b>1. Introduction</b>	<b>6</b>
1.1. Note to customer	6
1.2. Symbols used	6
<b>2. Support and contact details</b>	<b>7</b>
2.1. Sales and support contact	7
2.2. Installation assistance	7
<b>3. Standards</b>	<b>8</b>
3.1. CE Compliance	8
3.2. EMC	8
3.3. Electrical security	8
3.4. Restriction of Hazardous Substances Directive (RoHS)	8
3.5. EU Waste Electrical and Electronic Equipment (WEEE) Directive	8
<b>4. Safety information</b>	<b>10</b>
4.1. General	10
4.2. Installation and wiring	10
4.3. Environment and enclosure	11
4.4. ATEX	11
4.5. Power supply and grounding	11
4.6. Batteries and battery charging	12
4.7. Transport and storage	12
<b>5. System Description</b>	<b>14</b>
5.1. Introduction	14
<b>6. Design</b>	<b>15</b>
6.1. External appearance	15
6.2. Standard model	15
6.3. Indicators	16
<b>7. Specifications</b>	<b>17</b>
7.1. Vigilant-Permanent	17
7.2. Additional specifications with the Mobility case	18
<b>8. Installation</b>	<b>19</b>
8.1. Mechanical assembly	19
<b>9. Electrical installation</b>	<b>21</b>
9.1. Connectors	21
9.2. Power supply	21
9.3. Ground connection	22
9.4. Main inputs	23
9.4.1. IEPE sensor	24
9.4.2. Periodic Pulse Signal (Tachometer)	25
9.4.3. 4-20 mA Input Signal	25
9.4.4. Digital Inputs	26
9.4.5. COMMONSense Sensor 0-10 V (dynamic mode)	26
9.5. Auxiliary inputs	27
9.5.1. Periodic Pulse Signal (Tachometer)	28
9.5.2. 4-20 mA Signal	29
9.5.3. COMMONSense Sensor 0-10v (static mode)	30
<b>10. User Interface</b>	<b>31</b>
10.1. Introduction	31
10.2. Access	31
10.3. Navigation bar	32
10.3.1. Configuration tree	32
10.3.2. Interface Module	34
10.3.3. Exception indicator	34
10.3.4. Special unit indicator	34
10.3.5. Device status	35
10.3.6. Help button	35
10.3.7. User Menu	35
10.4. Basic interface elements	37
10.4.1. Forms	37
10.4.2. Lists	38
10.4.3. Expression Editors	39
10.4.4. How to create conditional expressions	46
<b>11. System Settings</b>	<b>48</b>
11.1. Introduction	48

11.2.	Menu Tree .....	48
11.3.	Status .....	49
11.4.	Users .....	51
11.5.	Host .....	53
11.6.	Network .....	54
11.7.	Time .....	54
11.8.	Services .....	55
11.8.1.	Remote technical support .....	56
11.8.2.	Email notifications .....	56
11.8.3.	Rsync and FTP services .....	58
11.9.	Storage .....	59
11.10.	Records .....	60
11.11.	Simulation files .....	62
11.12.	Bearing files .....	63
11.13.	Licenses .....	63
11.14.	Upgrade firmware .....	64
11.15.	Event Log .....	65
11.16.	Export/Import .....	66
11.16.1.	Main configuration .....	66
11.16.2.	System configuration .....	66
11.16.3.	User's configuration .....	67
<b>12.</b>	<b>Configuration .....</b>	<b>68</b>
12.1.	Introduction .....	68
12.2.	Toolbar .....	68
12.2.1.	Processing Blocks .....	69
12.2.2.	Apply button .....	69
12.3.	Sensors .....	70
12.4.	Inputs .....	73
12.5.	Bearings .....	74
12.6.	Fault Frequencies .....	77
12.7.	Modbus master .....	78
12.8.	Modbus slave .....	81
12.9.	OPC .....	83
12.9.1.	About OPC .....	83
12.9.2.	OPC UA client in Vigilant .....	84
12.9.3.	OPC endpoints .....	84
12.9.4.	OPC nodes .....	85
12.10.	Techniques .....	88
12.11.	Units .....	89
12.12.	Images .....	91
12.13.	Machines .....	92
12.14.	Alarms .....	95
12.14.1.	Hysteresis and Repetitions .....	97
12.14.2.	Statistical alarms .....	98
12.14.3.	Import and export alarms .....	99
12.15.	Components .....	99
12.16.	Points .....	100
12.16.1.	Dynamic points .....	102
12.16.2.	Static points .....	103
12.16.3.	Pulse tachometer points .....	107
12.17.	Processing Modes .....	109
12.17.1.	Waveform only .....	111
12.17.2.	Spectrum and waveform .....	112
12.17.3.	Demodulation .....	115
12.17.4.	Long waveform .....	117
12.17.5.	Order tracking .....	118
12.17.6.	Full spectrum .....	121
12.18.	Parameters .....	122
12.18.1.	Parameter types .....	123
12.18.2.	Parameter configuration .....	124
12.19.	Spectral Bands .....	134
12.19.1.	Single Band .....	135
12.19.2.	Harmonic Family .....	136
12.19.3.	Sideband .....	140
12.20.	States .....	142
12.21.	Storage Strategies .....	143

<b>13. Dashboard</b>	<b>146</b>
<b>13.1. Introduction</b>	<b>146</b>
<b>13.2. Dashboard Layout</b>	<b>146</b>
13.2.1. Desktop Toolbar	146
13.2.2. Edit Desktop Layout	147
13.2.3. Split Widgets	148
13.2.4. Merge Widgets	150
13.2.5. Select type of Widget	150
13.2.6. Add Desktop	151
13.2.7. Alarm Toolbar	151
13.2.8. Configuration tree	153
13.2.9. Global play	154
13.2.10. Global timeline	154
13.2.11. Keyboard shortcuts info	155
<b>13.3. Widgets</b>	<b>155</b>
13.3.1. Widget Toolbar	156
13.3.2. Timeline	156
13.3.3. Zoom usage	158
13.3.4. Filtering by Alarm or State	158
13.3.5. Dynamic cursor	158
<b>13.4. Parameter Matrix</b>	<b>159</b>
13.4.1. Configuration	159
13.4.2. Display	160
13.4.3. Cell Colors	160
13.4.4. Graph access	161
<b>13.5. Online Value</b>	<b>161</b>
13.5.1. Configuration	161
13.5.2. Display	162
13.5.3. Types of graphs	162
13.5.4. Access to trends chart	163
<b>13.6. Trends</b>	<b>163</b>
13.6.1. Configuration	163
13.6.2. Display	164
13.6.3. Zoom tools	166
13.6.4. Time range	166
13.6.5. Single cursor	166
<b>13.7. Spectrum</b>	<b>167</b>
13.7.1. Configuration	167
13.7.2. Display	169
13.7.3. Zoom	170
13.7.4. Fault Frequencies	171
13.7.5. Cursors	171
<b>13.8. Waveform</b>	<b>174</b>
13.8.1. Configuration	174
13.8.2. Display	175
13.8.3. Zoom	177
13.8.4. Cursors	178
13.8.5. Runout Compensation	179
13.8.6. Synchronous View	179
<b>13.9. Mimic</b>	<b>180</b>
13.9.1. Configuration	180
13.9.2. Display	181
13.9.3. Points Visualization	181
<b>13.10. Image</b>	<b>181</b>
13.10.1. Configuration	181
13.10.2. Display	182
<b>13.11. Circular waveform</b>	<b>182</b>
13.11.1. Configuration	182
13.11.2. Display	184
13.11.3. Cursor	185
<b>13.12. Waterfall</b>	<b>186</b>
13.12.1. Configuration	186
13.12.2. Display	187
13.12.3. Frequency scale selector	188
13.12.4. Time scale selector	188
13.12.5. Cursors	189

<b>13.13.</b>	<b>Orbit</b> .....	<b>189</b>
13.13.1.	Configuration .....	189
13.13.2.	Display .....	191
13.13.3.	Zoom .....	192
13.13.4.	Single cursor .....	192
<b>13.14.</b>	<b>Phase Diagram</b> .....	<b>193</b>
13.14.1.	Configuration .....	193
13.14.2.	Display .....	195
13.14.3.	Single cursor .....	196
<b>13.15.</b>	<b>Long Waveform</b> .....	<b>196</b>
13.15.1.	Configuration .....	197
13.15.2.	Display .....	199
13.15.3.	Single cursor .....	199
<b>13.16.</b>	<b>Shaft Centerline</b> .....	<b>200</b>
13.16.1.	Configuration .....	200
13.16.2.	Display .....	202
13.16.3.	Single cursor .....	202
<b>13.17.</b>	<b>Full spectrum</b> .....	<b>203</b>
13.17.1.	Configuration .....	203
13.17.2.	Display .....	205
13.17.3.	Zoom .....	206
13.17.4.	Fault Frequencies .....	206
13.17.5.	Cursors .....	207
<b>14.</b>	<b>Maintenance</b> .....	<b>209</b>
14.1.	Relevant aspects .....	209
14.2.	Periodic inspections .....	209
14.3.	Reboot .....	209
14.4.	Rescue mode .....	210
14.5.	Micro-SD card maintenance .....	210
14.6.	Replacement of internal components .....	211
14.6.1.	Access to the rear compartment .....	211
14.6.2.	Battery replacement .....	213
14.6.3.	Fan replacement .....	214
14.6.4.	Micro-SD card replacement .....	215
14.7.	Troubleshooting .....	216
<b>15.</b>	<b>Basic Operations</b> .....	<b>218</b>
15.1.	Starting Up the Unit .....	218
15.2.	Powering off the unit .....	218
15.3.	Upgrading the firmware .....	218
15.4.	Using RSync and FTP for system backups .....	219
<b>16.</b>	<b>Appendix A</b> .....	<b>220</b>
16.1.	Creating simulation files .....	220
<b>17.</b>	<b>Appendix B</b> .....	<b>221</b>
17.1.	Optional Licenses .....	221
<b>18.</b>	<b>Appendix C</b> .....	<b>222</b>
18.1.	Network Ports .....	222
18.1.1.	Incoming connections .....	222
18.1.2.	Outgoing connections .....	222
<b>19.</b>	<b>Appendix D</b> .....	<b>223</b>
19.1.	Keyboard Shortcuts .....	223

# 1. Introduction

## 1.1. Note to customer

This manual contains information about how to install and use your *Vigilant* unit. We recommend carefully reading and understanding this manual before using the device.

Following the instructions will help you reduce damages or malfunctions of the system, avoiding downtime and maintenance costs. We recommend keeping a copy of this manual available for consultation at all locations that you might need, and in a readable condition.

When using this product, it is necessary to be knowledgeable about the information in this manual and any instrumentation connected to it. Also, it requires general safety information, in addition to the safety information provided in this manual.

Depending on the options purchased with the equipment *some of the functions described in this User Manual might not be available to you.*

If the *Vigilant* module combines with other instrumentation and then resold or transferred as part of assembly, be sure that following manual gives to the end user.

When disposing of a product, follow the local laws and regulations.

In no event will **SDT** be responsible for errors, omissions or inconsistencies that may contain in this manual, nor for indirect and consequential damages either, including any lost profits or savings resulting from the use or application of this equipment.

Information in this document is subject to change without notice. It does not represent a commitment on part of **SDT**. The information in this document is not all-inclusive and cannot cover all unique situations.

The examples and diagrams in this manual are included solely for illustrative purposes. **SDT** cannot assume responsibility or liability for actual use based on the examples and diagrams due to the many variables and requirements associated with any installation.

This User Manual protects by copyright, and all rights are reserved. No part of this publication may be duplicated, reproduced, reprinted, transmitted in any form or by any means, whether electronic, mechanical, photocopying, recording, or other means, or translated, recorded, edited, abridged or expanded, without the express written permission of **SDT**.

## 1.2. Symbols used

The following symbols and paragraph styles indicate information of special interest:



This label identifies information intended to draw attention to potential sources of danger for personnel, environment, system or machinery.



This label identifies information that provides essential advice to follow to understand and apply the product.

## 2. Support and contact details

### 2.1. Sales and support contact

Address:

#### SDT North America

Toll Free: 1-800-667-5325

Phone: 1-905-377-1313

7677 County Road 2

Cobourg ON K9A 0X4,

Canada

Email: [info@bevigilant.io](mailto:info@bevigilant.io)

Web page: <https://bevigilant.io>

#### SDT International

Phone: +32 (0) 2 332 32 25

Bd. de L'Humanité 415

B-1190, Brussels

Belgium

Email: [info@sdtultrasound.com](mailto:info@sdtultrasound.com)

### 2.2. Installation assistance

If you experience a problem with a *Vigilant* unit, please, review the information contained in this manual. You can also contact our Customer Service and helping in getting your *Vigilant* unit up and running by calling to this number: **1-800-667-5325** or **+32 (0) 2 332 32 25**.

**SDT** provides technical information on the web to assist you in using our products. Visit our web page <https://bevigilant.io> to download technical manuals and other documents.

## 3. Standards

*Vigilant* has been designed and tested to meet the following directives and standards.

### 3.1. CE Compliance

The product meets the essential requirements of the applicable European Directives as follows:

- 2014/30/EU; Electromagnetic Compatibility Directive (EMC)
- 2011/65/EU; Restriction of Hazardous Substances (RoHS)

### 3.2. EMC

The product is tested to meet the Electromagnetic Compatibility (EMC) EU Directive, by applying the following standards:

- *EN 61000-6-1:2007 EMC. Immunity standard for residential, commercial, and light-industrial environments.*
- *EN 61000-6-3:2007/A1:2012 EMC. Emission standard for residential, commercial, and light-industrial environments*

### 3.3. Electrical security

The product via the standard power supply has been designed and tested to meet the following electrical security standards:

- *EN 62368-1:2018: Audio/video, information, and communication technology Equipment – Part 1: Safety requirements*

### 3.4. Restriction of Hazardous Substances Directive (RoHS)

All the components, subassemblies and supplies used to manufacture the product complies with the European Union *2011/65/EU* directive on the restriction on using dangerous substances in manufacturing electronic and electrical appliances (RoHS-2).

### 3.5. EU Waste Electrical and Electronic Equipment (WEEE) Directive

In August of 2005, the European Union (EU) implemented the EU WEEE Directive *2002/96/EC* and later the WEEE Recast Directive *2012/19/EU* requiring Producers of electronic and electrical equipment (EEE) to manage and finance the collection, reuse, recycling and to appropriately treat WEEE that the Producer places on the EU market after August 13, 2005. This Directive aims to minimize the volume of electrical and electronic waste disposal and to encourage reuse and recycling at the end of life.

If you have purchased **SDT** branded electrical or electronic products in the EU and intended to discard these products at the end of their useful life, please do not dispose of them with your other household or municipal waste. **SDT** has labeled its branded electronic products with the WEEE Symbol (figure) to alert our customers that products bearing this label should not be disposed of in a landfill or with municipal or household waste in the EU.





Instead, please be aware that **SDT** makes a return and collection system available to you, free of transportation and reuse and/or recycling costs.

Please contact **SDT** on the following address:

#### **SDT North America**

Toll Free: 1-800-667-5325

Phone: 1-905-377-1313

7677 County Road 2

Cobourg ON K9A 0X4,

Canada

Email: [info@bevigilant.io](mailto:info@bevigilant.io)

Web page: <https://bevigilant.io>

#### **SDT International**

Phone: +32 (0) 2 332 32 25

Bd. de L'Humanité 415

B-1190, Brussels

Belgium

Email: [info@sdtultrasound.com](mailto:info@sdtultrasound.com)

Web page: <https://sdtultrasound.com/products/permanent-monitoring/>

And we will inform you how to proceed in this case.

## 4. Safety information

### 4.1. General

The **Vigilant** monitoring system is designed to meet the safety regulations. However, its safety can be at risk if the equipment is installed or used by unqualified staff, used improperly, or not inspected and maintained.



Installation, operation, and maintenance of the system should only be undertaken by specialist personnel and following the safety and accident prevention regulations.



Repairs of the system should only be undertaken by **SDT**, or by personnel authorized by **SDT**.

It must be ensured during operation, installation, or maintenance that all safety instructions have been followed, along with all safety regulations that might apply.

### 4.2. Installation and wiring

Before starting the installation, work read the instructions delivered with the equipment. Stop the installation work if you have any doubt and contact your distributor or **SDT** for assistance.



Be sure that main power is off and will stay off until the installation work ends. Check that the equipment is voltage-free by using a voltage tester. You should always install the equipment isolated from the power supply or any electrical power source.



Inspect all components to be installed. Check they are all in good condition and do not present any damage. Reject components that contribute any damage.



Check that all materials to be installed are compliance with EU directives or international regulation concerning electrical safety.

Foreign materials, like protective material used for transportation, dirt, or any other pollutant, must be removed before installing the equipment.

Choose installation tools that are safe and suitable for the working environment.

Check all components have been professionally installed and connected. Wiring should follow these requirements:

- Use 17 to 22 AWG copper conductors (AWG 20 recommended) for wiring the equipment. For a ground terminal an AWG 17 size conductor is suggested.

- Use a minimum size of AWG 17 for grounding the DIN rail.
- Solid or stranded conductors are allowed.
- Ensure all cables and terminals are in proper condition and do not show any visual defect.
- Cables should not be twisted or allowed to run over sharp edges.
- Make sure that cables are arranged so do not disturb or have any effect on control functions.
- Wire end ferrules must be used for stranded conductors.
- Soldering the conductor is forbidden.

### 4.3. Environment and enclosure

The *Vigilant* modules supplies as “open type” devices, meaning it should be installed in an enclosure suitable for the environment conditions present and prevent any damage to personnel.



See NEMA or IEC standards for further information about the degree of protection provided by the different types of enclosures.

The equipment is intended for use in Pollution Degree 2 Industrial environment, in overvoltage Category II applications, at altitudes up to 2000 meters.

See [Specifications](#) for environment specifications applied for the equipment.

### 4.4. ATEX

The equipment has not been designed to be installed in potentially explosive atmospheres.



When using the equipment in potentially explosive atmospheres it must be installed following and complying with the national and international regulations. Final user should be responsible to ensure the safety of the system when installing the equipment in this type of environment.

### 4.5. Power supply and grounding

Power requirements for the equipment are given at the [Specifications](#). Be sure that the installation meets those specifications before powering the device.



Failure to meet the power specifications may result in a risk for personnel or damage to the equipment.



Make sure, before powering the equipment that no pending wiring work is present that might be a risk for personnel or the installation.



Before installing the equipment, calculate the total power required for all the *Vigilant* modules in the cabinet. Refer to the specifications for the requirements that must comply with the power supply.

Grounding ensures safe electrical circumstances and helps avoid potential electromagnetic interferences and noise. Make sure ground has been connected correctly and securely, in compliance with current regulations, before switching on the equipment.

The equipment must connect to ground using the screw terminal marked with the earth IEC symbol and provided in one of the connectors. Make sure that the protective earth conductor is connected correctly to that ground terminal. Additionally, the equipment makes a chassis ground connection through the DIN rail, which in turn must relate to the ground.



Make sure to use DIN rail with good conductive properties. It is recommended to use steel DIN rails. Do not use DIN rails made of plastic or poor conductor materials. Ensure the DIN rail is not oxidized or corroded or presents any other defects resulting from improper chassis grounding.



For metallic enclosures it is a highly recommended enclosure that is connected to ground to avoid potential EMI or noise interferences going into the equipment.



Failure to ensure a correct ground connection may result in an electrical risk and cause the equipment to work in an unfavorable operating condition.

See [Electrical installation](#) for the wiring details about how to connect the power supply and grounding on the equipment.

#### 4.6. Batteries and battery charging

The *Vigilant* has a rechargeable internal lithium-polymer battery as its auxiliary power supply. The integrated battery recharges automatically when the device is connected to the main DC power adaptor. The equipment battery is assembled inside, under a cap located in the back of the instrument and closed by screws. See chapter dedicated to [Replacement of internal components](#) to read more about the battery and its possible replacement.

The Battery is mainly used to properly shut down the system.



The system has been designed for a specific battery model, which also includes an integrated electrical protection system. In no event should the battery be replaced with a different model.



Access to the battery for replacement, if necessary, must be carried out by personnel authorized by the product manufacturer or distributor.

#### 4.7. Transport and storage

Transportation and storage of the equipment must only be done using the original packing provided on its delivery. Be sure the packing is in good condition and does not present significant damages.



Protect the equipment against humidity during its transportation and storage, even when using the original packing.



Do not use the equipment if it presents damage after transportation or storage due to improper or careless handling.

Please place it in a location free from direct sunlight, high temperature or humidity, or the corrosive environment when storing the equipment. See [Specifications](#) for the specific environment conditions for the transportation and storage.

## 5. System Description

### 5.1. Introduction

*Vigilant* Online Machinery Supervisor is a state-of-the-art monitoring system whose purpose is to provide users with the measurements required for assessing the condition of the machinery or equipment being monitored.

*Vigilant* is a smart solution for protection, **condition monitoring** and failure mode identification of critical machinery. It can work as a standalone system, it does not require a permanent connection to a computer or software, while still measuring and protecting the equipment, storing data or even communicating scalar measurements to other systems via Modbus, TCP protocol or API-rest.

It accepts both static and dynamic signals from most kinds of sensors typically used for condition-based monitoring: vibration, temperature, ultrasound, thermal images, speed, motor current, oil condition parameters, load, process, etc.

*Vigilant* is a small size and low consumption hardware device. It integrates a web server application that provides an interface for users through a web browser, without installing any software. With that web interface, the user can configure and access all data being measured in the unit, along with all the types of graphs required for its visualization and analysis (trends, spectrum, waveform, parameter tables, etc.). It also provides data storage with enough capacity for enabling monitoring of extended periods. The advantages of this new technology are:

- It eliminates the need for a local server, and therefore its maintenance is also eliminated.
- It can be connected directly to the Internet, so the measurements can be accessed from any part of the world using a computer or device connected to the Internet and a web browser.
- It is not required to pay for software licenses to access the data.
- Access is not limited to specific operating systems, computers, or devices.
- Obsolescence is avoided by applying automatic updates.
- It is very intuitive, accelerating the learning curve and allowing users to access all the start functionality.
- Reduce the initial investment by simplifying the monitoring system.
- The system includes 8 analog inputs with simultaneous high-frequency sampling and 4 additional low-frequency sampling analog inputs.
- *Vigilant* also includes bidirectional communication via Modbus-TCP protocol for its integration with external systems.

## 6. Design

### 6.1. External appearance

At the front and back sides of *Vigilant* several pluggable terminal blocks allow connecting wires both for sensor signals and power supply. All these terminals are to be connected only to SELV-LPS (safety low-voltage) lines.

*Vigilant* also has an RJ45 port for Ethernet communications (100Base-TX). The Ethernet port is to be connected to indoor routed networks exclusively.

Next to the RJ45 port, the case includes a USB connector of A-type that can be used as a power supply. The port can't be used to interact with VIGILANT.

On the top of the instrument, several LED indicators give information about the device's state and the signals being read. The meaning of the colors used is described below.

The following chapters contain some images with more detailed information about the *Vigilant* and its hardware.

### 6.2. Standard model

The *Vigilant* has 8 main dynamic analog inputs (high-frequency sampling rate) and 4 auxiliary inputs (low-frequency), for static analog sensors or tachometers.

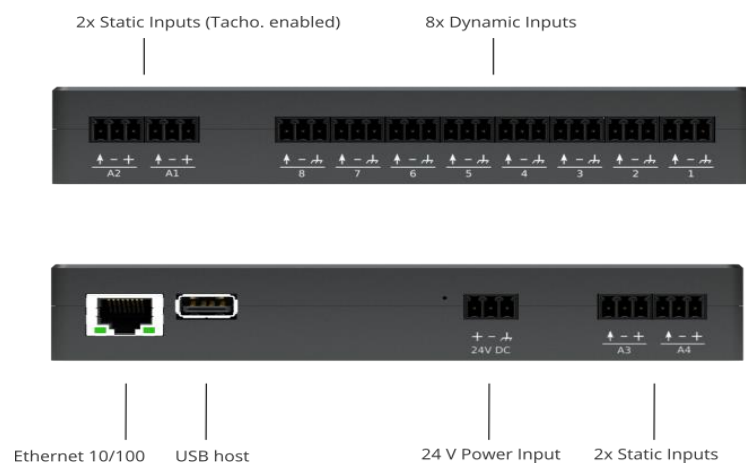

The standalone Vigilant system is designed for permanent mounting on DIN rail. The mobility Vigilant system embeds the same main functions as Vigilant Permanent while offering various wireless possibilities (4G, WIFI (access point or client), etc.). It's packaged in rugged, custom waterproof case designed to travel to off-site assets. It can be installed on critical assets to closely monitor until planned shutdown.



### 6.3. Indicators

The following table describes the light indications (LEDs) available on the front face:

LED	Color status	Description
Status	White	Entering power-up or power-down stage.
	Blinking blue	Unit starting or shutting down in normal mode
	Blinking red	Unit starting or shutting down in rescue mode
	Solid blue	Unit is on and ready. Power supply is ok.
	Solid red	Unit is in rescue mode.
Ethernet connector	Yellow or green	Link/Activity
Input ports (Any type)	Off	The input channel is either disabled, or if enabled, it is processing the sampling data.
	Green	Channel is measured, and no alarm is detected for all the measurements done on the channel.
	Orange	Channel is measured and at least one of the measurements of the channel is in warning or alert condition.
	Red	Channel is measured and at least one of the measurements of the channel is in alarm or fault condition.



## 7. Specifications

### 7.1. Vigilant-Permanent

The following table shows the specifications for the standard version of the *Vigilant* device:

General		
Function		Multi-channel acquisition system
Operable with		Provided sensors (voltage output)
Main dynamic inputs		8 channels (for vibration and ultrasound)
Auxiliary inputs		4 channels (ex: tachometer, temperature, etc.)
USB port		1 Host, used as power supply only
Status indicators		13xRGB LED
Power supply	V	20-26 V DC, 24 V DC nominal
Power consumption	W	<12
Internal battery (for safe shutdown only)		Lithium-Po, 3.7 V 1300 mAh
System features		
Operating system		Dedicated webserver application
CPU		ARM Cortex™-A9 Quad Core (NVIDIA® Tegra™ 3)
Frequency clock	GHz	1.4
RAM	GB	1
Firmware		Free of charge, regularly updated (see user manual)
Storage capacity	GB	4, Micro-SD card, format ext3
Database system		SQLite
Network interface		Ethernet 10/100
Communication		DHCP/static configuration
Default IP access		192.168.0.150
Industrial communication		MODBUS TCP/IP (client and/or server) & OPC UA
Backup option		FTP, Rsync or rest API
Mechanical features		
Mounting		Standard 35 mm DIN rail
Sensor interface		3-pole pluggable terminal block provided with the unit
Size of the unit	mm(inch )	LxLxh: 162x95x27 (~6.38x3.74x1.06)
Weight of the unit	kg (oz)	0.55 (~19.4)
Operating temperature range	°C (°F)	-30 to +44.5°C (-22 to 111.2 °F), non-condensing
Humidity	%	95% RH
Approvals		EMC compliant (directive 2014/30/EU) WEEE compliant (directive 2012/19/EU) ROHS compliant (directive 2011/65/EU)
Signal acquisition		
		Main inputs (from 1 to 8)
Sampling rate	Hz	Up to 51200
DC range	V	± 24
AC range	Vpp	24
IEPE/ICP Sensors drive current		5.5mA @20V
ADC resolution	bits	16
Input configuration modes		Dynamic, Static, Digital, Pulse train
Harmonic distortion	dB	-70

Accuracy	%	1
Dynamic range	dB	110
Gain	dB	0 to 42, range of +6
Points type		Dynamic (preferred), Static, Tachometer
		Auxiliary inputs (A1, A2, A3 and A4)
Sampling rate	Hz	Up to 200
DC range	V	± 24
ADC resolution	bits	16
Power output	V	+24
Input configuration modes		Static, Pulse Train (A1 and A2 only)
Accuracy	%	1
Gain	dB	0 to 30, range of +6
Points type		Static, Tachometer (A1 and A2 only)
<b>Signal processing</b>		
Spectral lines		Up to 12800
Time waveform samples		128 up to 262016
Windows type		Hann, Hamming, Blackman, Rectangular
Processing modes		Waveform, Spectrum & Waveform, Demodulation, Long Waveform, Order Tracking
Parameters		Mean, RMS, True Peak, True Peak to Peak, calculated Peak, calculated Peak to Peak, spectrum RMS, Peak extraction, Frequency extraction, Crest Factor, Kurtosis, Peak phase, Smax
Available filters		Butterworth, Bessel, Chebyshev
Number of averages		1 up to 32
Overlap	%	0 up to 99
Bearing database		Included 50 k bearing references
<b>Warranty</b>		
Lifetime warranty		Visit <a href="http://www.sdtultrasound.com">www.sdtultrasound.com</a> for details

## 7.2. Additional specifications with the Mobility case

<b>Mobility case</b>		
Function		Mobile acquisition system, design to travel to off-site assets
Composed of		<ul style="list-style-type: none"> <li>• 1 Vigilant unit</li> <li>• pre-wired configurations</li> <li>• gateway for advanced communications</li> <li>• rugged, custom, waterproof case</li> <li>• AC/DC convertor</li> </ul>
Connectivity options  (Gateway <a href="#">Teltonika RUT 240</a> preconfigured by SDT)		<ul style="list-style-type: none"> <li>• WIFI (access point)</li> <li>• WAN &amp; LAN</li> <li>• 4G (LTE)</li> </ul> <p>2 antennas provided</p>
Configuration (rear-panel)		<ul style="list-style-type: none"> <li>• 8 x M8 Female 4 Pole for the main inputs</li> <li>• 4 x BNC for the static inputs</li> <li>• 1 x M12 (common with A1 &amp; A2)</li> </ul>
Power supply	V	220 V AC with the provided AC/DC adaptor
Default IP access		10.8.2.150 (from the ethernet port of the case)

## 8. Installation

### 8.1. Mechanical assembly

The *Vigilant* system was not designed as an “enclosed type” system. That means that it generally requires to be installed in an external enclosure prepared for the application site’s environmental conditions.

The unit includes an accessory to be mounted on standard DIN rail (35 mm rail). Using the accessory installed at the back of the casing, it can be mounted on a DIN rail fastened to the mounting panel of the enclosure.

The following pictures describes the steps for assembling or removing the *Vigilant* from the DIN rail.

To install the unit on a DIN rail, align it with the top edge, press firmly downwards and push forward the lower end into position.

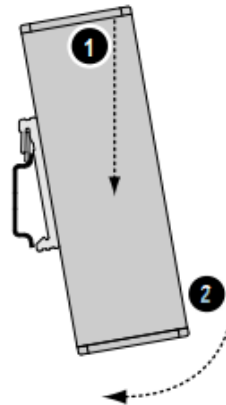

To remove the unit, press firmly on top downwards, and pull the lower end away from the DIN rail.

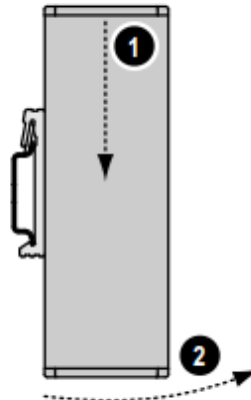

Vigilant includes a forced ventilation system that regulates its temperature. However, to guarantee proper air cooling, the enclosure’s temperature must be kept within the allowable limits (see Specifications). It must consider the heating caused by all components within the enclosure, installing a forced ventilation system if required.



Allow some free space around the air input grid and equipment’s fan output to ensure proper air cooling. To improve heat dissipation, remove any insulation material close to the unit.



Outdoor installations are particularly susceptible to condensation. This should be avoided by installing the corresponding components within the enclosure. Direct sunlight and high ambient temperatures should be avoided. It is recommended to separate the unit from any external heat source that could cause high temperatures.



It is the assembler's responsibility to ensure the environmental conditions described at the specifications of the unit.

## 9. Electrical installation

### 9.1. Connectors

Connections into channels and power supply are achieved by using pluggable screw terminal blocks that are provided with the unit. In both cases, the *Vigilant* uses the same type of connector, a 3-pole pluggable screw terminal block with **3.81 mm pitch**. The following picture shows this type of terminal block:



This type of connectors admits wires from 0.2 up to 1.5 mm<sup>2</sup>. However, it is recommended to use 0.5 mm<sup>2</sup> wires (AWG 20).



All the inputs of the *Vigilant* may only be connected to SELV circuits. SELV stands for Safety Extra Low Voltage. For *Vigilant*, maximum voltages range  $\pm 24V$  DC. That applies both for power and signal connections, including all inputs.

*Vigilant* also has a RJ45 port on the left part of the front of the case used for Ethernet communications (100Base-TX).



The Ethernet port is to be connected only to indoor routed networks.

Next to the RJ45 port there is an USB connector of A-type used to supply slave devices.



USB port cannot be used to access the unit. It simply brings a usb power supply

### 9.2. Power supply

The *Vigilant* must be powered with a nominal 24 V DC LPS power supply. Only SELV / LPS complying with EN 62368-1 (or EN 60950-1), referring to Low Voltage Directive 2014/35/EU, must be connected to the power supply terminals. Voltage can vary from 20 to 26 VDC, as described in the specifications (see [Specifications](#)).

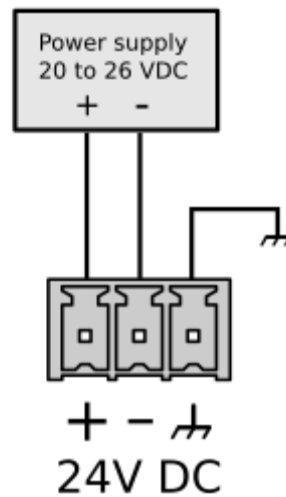

The maximum power consumption is below 12W (500mA under 24 VDC).

The *Vigilant* case, DIN clip and chassis ground terminals are connected (more information in next section: Ground connection).



It requires a CE power supply certified (or equivalent) to power the unit. The power supply must be permanently earthed and must be connected to the ground of the installation.



Be aware that the voltage supplied will be used internally for powering the IEPE sensors, which in turn might require a minimum voltage supply to power them correctly.

### 9.3. Ground connection

All the connectors for the main analog inputs of the *Vigilant*, and the power input connector, have a terminal for chassis ground connection. All those terminals are connected in between and, in turn, both to the *Vigilant* case and the DIN rail clip.



Grounding provides a safe electrical operating system and helps avoiding potential EMI and electrical noise that can cause unfavorable operating conditions in the unit or noisy measurements. Follow the grounding requirements described in this chapter to ensure the system's safe operation and minimize noise interferences.

To avoid noise problems, some installations may require a ground connection for sensors and instrumentation separated from the safety ground, which is typically connected to the cabinet casing. In such cases, *Vigilant* must be connected to the instrumentation ground, and it must be ensured that the DIN rail where the *Vigilant* is supported is isolated from the safety ground.

The following pictures shows an example of how to isolate the DIN rail from the cabinet.

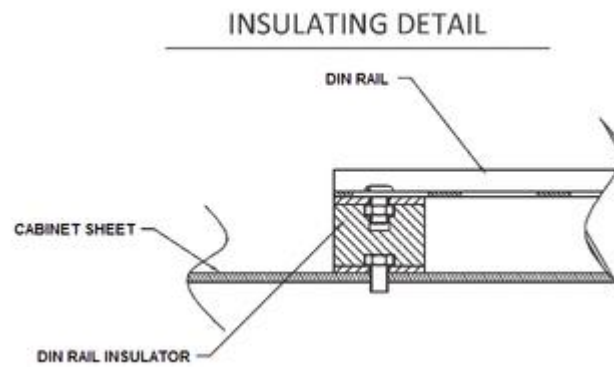

It is recommended to connect *Vigilant* ground terminal to the instrumentation ground and the DIN rail where the *Vigilant* is supported.

The DIN rail can be grounded connecting it directly to the ground bus (as shown above), or by using a rail grounding terminal (shown below).

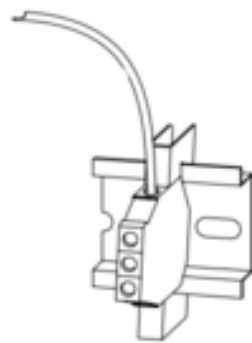

#### 9.4. Main inputs

The main inputs or *high-frequency inputs* of the *Vigilant* share the following configuration:

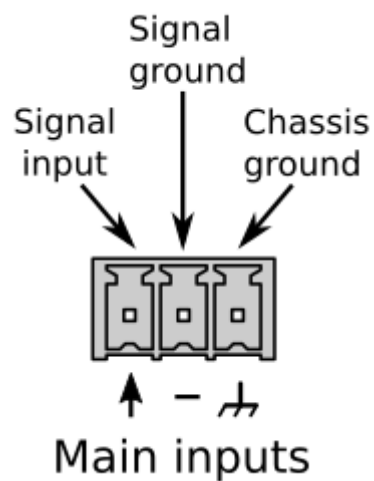

These inputs admit voltage signals in the range of  $\pm 24$  V (24 Vpp in AC mode). They have been designed to accommodate fast signals coming from sensors like accelerometers, tachometers or displacement probes. They can also read slower signals like temperature probes or others.

As all the main input connectors include a signal ground (0V reference) terminal, as shown in the image. All those terminals, labeled as “-”, are connected internally to the circuit 0V reference, and they are also in electrical contact with the negative terminal of the power input.



The signal terminal of the main inputs *Vigilant* connect to a current source of about 5.5 mA, activated for powering ICP/IEPE transducers, like many sensors.

A typical connection between the high-speed inputs and any generic sensor shows in the following picture:

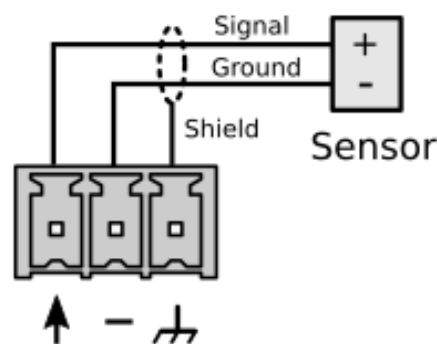

This scheme is valid for any kind of sensor with external power supply and voltage output (either analog or digital).

In the following sections there will show the typical connection between different types of sensors and the main inputs:

#### 9.4.1. IEPE sensor

The system can power IEPE (also known as ICP) accelerometers and velocimeters connected to the main inputs connected just as shown below:

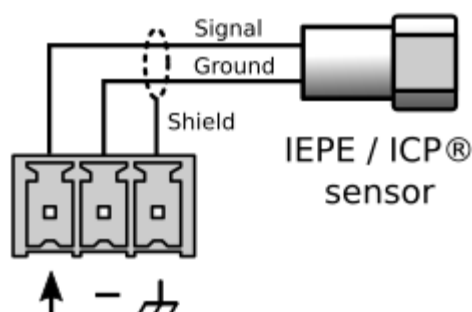

The system supplies 5.5 mA (approx.) to the sensor for the IEPE power. This option must also be activated in the webserver.





It is recommended to use a shielded cable to avoid noise in the signal, as shown above. Ensure this shield is grounded. To avoid loops and noise, make sure just one of the cable's sides connects to ground. Typically, grounding is done in the cabinet side.

#### 9.4.2. Periodic Pulse Signal (Tachometer)

Main inputs may also be configured for detecting the speed from a periodic pulse signal. The pulse detection of the signal is based on a trigger voltage (threshold) and a hysteresis value defined by the user, referring to the datasheet of the sensor.

Tachometers are used mainly to detect the speed of a rotating machine. Typically, tachometers are based on proximity sensors. Most used sensors are magnetic (Hall effect) and optical (infrared transducers). In either case, most industrial proximity sensors can be powered at 24 V, and they usually have an open collector output.

In case the sensor has an NPN output type, the standard connection between the sensor and the main inputs would look like this. Please note that the pull-up resistor may be included into the tachometer.

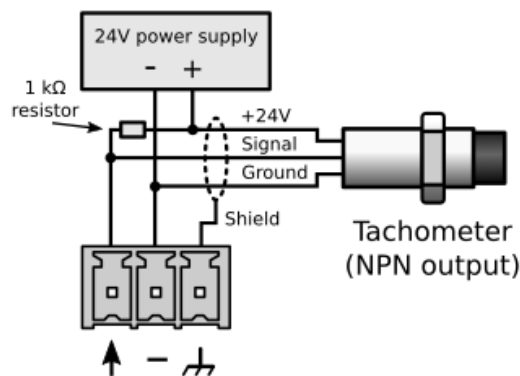

In case the sensor has a PNP output, the connection would look like this:

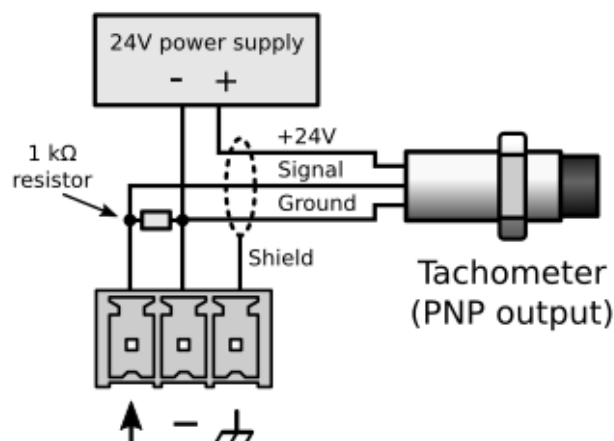

It is recommended to use a shielded cable to avoid noise in the signals. The shield must be grounded at one side of the cable (typically at the cabinet side).

#### 9.4.3. 4-20 mA Input Signal

It is possible to configure dynamic inputs to measure 4-20 mA current loop signals. This kind of current loop is an industry-standard commonly used in many applications. They have the advantages of simplicity and noise immunity and have a large international user and equipment supplier base.

To acquire this type of signals from the main primary inputs, user must connect a resistance on the terminals to convert the current signal into a voltage. The following graphs show the wiring required for both active and passive 4-20 mA loop sensors:

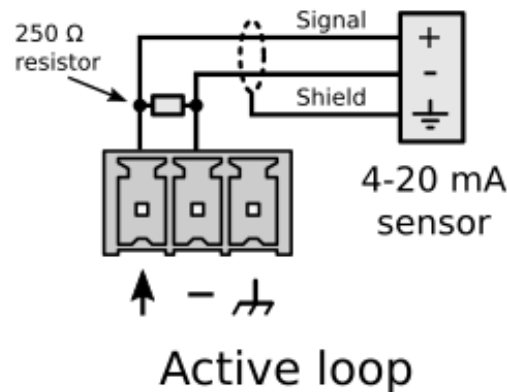

Many sensors in the market can use the current loop for powering themselves, without needing any other power source (*passive loop*). However, the terminals of the *Vigilant* do not have the possibility of powering the sensors in that way. Thus in between the sensor and *Vigilant* must add an external power source:

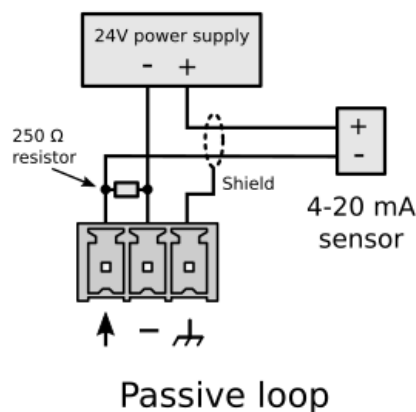

It is recommended to use a shielded cable to avoid noise in the signals. The shield must be grounded at one side of the cable (typically at the cabinet side).

#### 9.4.4. Digital Inputs

Main inputs can be configured as a digital input. This means the channel will measure a value of 1 (true) or 0 (false) depending on the signal's DC voltage. A hysteresis applies close to this setting value. The user can configure both DC voltage and hysteresis.

As an example, if the threshold is set up in 1 V, and hysteresis is defined in 0.1 V, the input will measure a value of 1 when the DC voltage of the input goes above 1.1 V. And then it will measure a value of 0 when the voltage goes below 0.9 V.

#### 9.4.5. COMMONSense Sensor 0-10 V (dynamic mode)

Note that the sensor needs an external 24V DC supply capable of delivering at least 40 mA. Utilizing the power supply supplied with the *Vigilant* is acceptable or a separate dedicated power supply can be used.

The pinout of the sensor, extracted from the datasheet, is recalled hereunder.

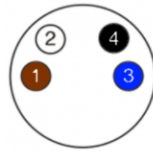

1 = 24V DC Power supply (+) (Brown Cable Wire)

2 = Voltage output (V out) (White Cable Wire)

3 = 0V (-) (Blue Cable Wire)

4 = Communication line (should be left floating if not used) (Black Cable Wire)

The following diagram shows the wiring required for connecting the sensor to the VIGILANT:

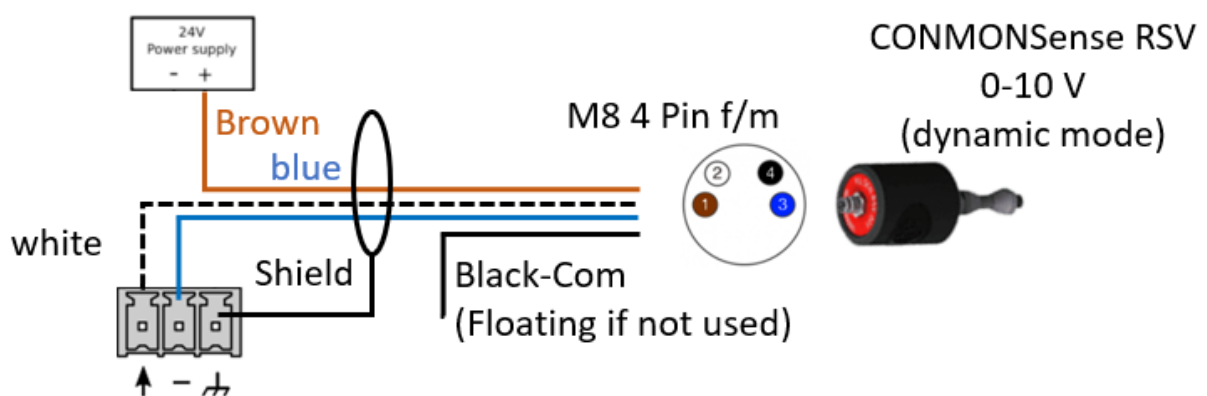

COMMONSense sensors are provided in a default configuration (dynamic mode, Gain = +60 dB)

The appropriate gain of the sensor equivalent to “apparent sensitivity” must be adjusted during the installation using the configuration box to easily change these settings.

Each change must also be applied accordingly in the VIGILANT

Please refer to the datasheets of these sensors for further details



In dynamic mode, COMMONSense sensors deliver an AC signal, centered around 3 V (Bias) that is directly linked to the heterodyned ultrasound signal.

## 9.5. Auxiliary inputs

The connectors for the auxiliary analog inputs available in the *Vigilant-P* has the following configuration:

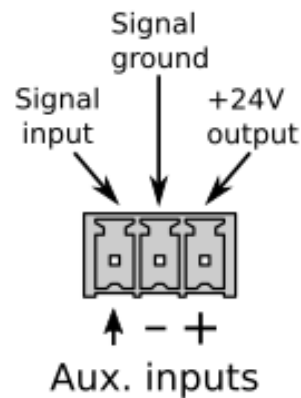

The auxiliary inputs admit voltage signals in the range of  $\pm 24$  V and design to read analog signals at slow rates.

As it is shown in the image, all the auxiliary inputs connectors include a signal ground (0V reference) terminal. All those terminals, labeled as “-”, are connected internally to the circuit 0V reference, and they are also in electrical contact with the negative terminal of the power input.

The auxiliary inputs connectors also have a terminal with a +24 V power output, available for powering external sensors or peripherals. All those terminals, labeled as “+”, are connected internally to the circuit +24 V power input.

A typical connection for a generic sensor to these inputs, with self is shown in the following picture:

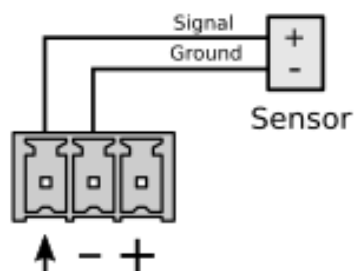

This scheme is valid for any kind of sensor with external power supply and voltage output (analog or digital).

In the following sections will show the typical connection between different kinds of sensors and the auxiliary inputs.

#### 9.5.1. Periodic Pulse Signal (Tachometer)

Some of the auxiliary inputs may also be configured for detecting the speed from a periodic pulse signal. The pulse detection of the signal is based on a trigger voltage (threshold) and a hysteresis value defined by the user.

Tachometers are used mainly to detect the speed of a rotating machine. Typically, tachometers are based on proximity sensors. Most used sensors are magnetic (Hall effect) and optical (infrared transducers). In either case, most industrial proximity sensors can be powered at 24 V, and they can be powered from the +24 V output terminal.

The connection between the auxiliary inputs and a tachometer with analog or digital inputs would look like this:

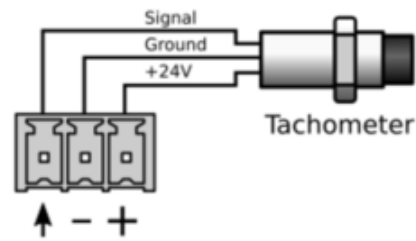

In case the sensor has a NPN output type, the normal connection between the sensor and the auxiliary inputs would be something like this:

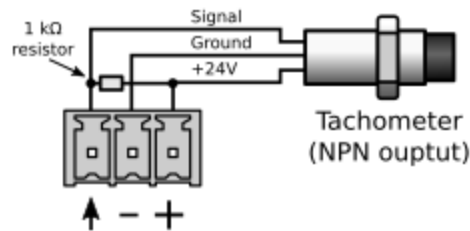

In case the sensor has a PNP output, the connection would look like this:

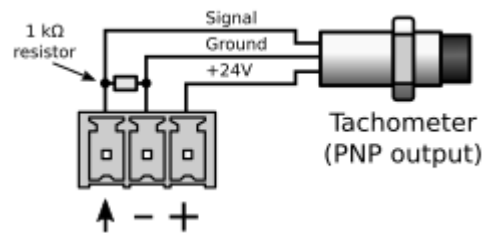

### 9.5.2. 4-20 mA Signal

Dynamic inputs can be configured to measure 4-20 mA current loop signals. This kind of current loop is an industry-standard used in many applications. They have the advantages of simplicity and noise immunity and have a large international user and equipment supplier base.

In order to read this type of signals from the main inputs a resistance must be connected on the terminals in order to convert the current signal into a voltage. The following graphs show the wiring required for a passive 4-20 mA loop sensor:

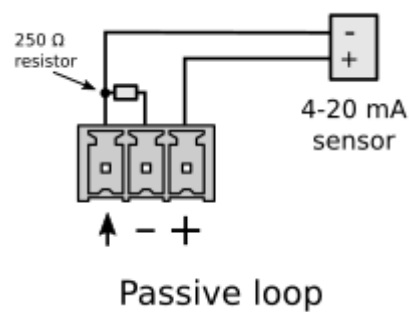

### 9.5.3. COMMONSense Sensor 0-10v (static mode)

Note that the sensor needs an external 24V DC supply capable of delivering at least 40 mA. Utilizing the power supply supplied with the Vigilant is acceptable or a separate dedicated power supply can be used.

The pinout of the sensor, extracted from the datasheet, is recalled hereunder.

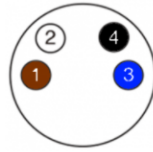

1 = 24V DC Power supply (+) (Brown Cable Wire)

2 = Voltage output (V out) (White Cable Wire)

3 = 0V (-) (Blue Cable Wire)

4 = Communication line (should be left floating if not used) (Black Cable Wire)

The following diagram shows the wiring required for connecting the sensor (configured in static mode) to the VIGILANT:

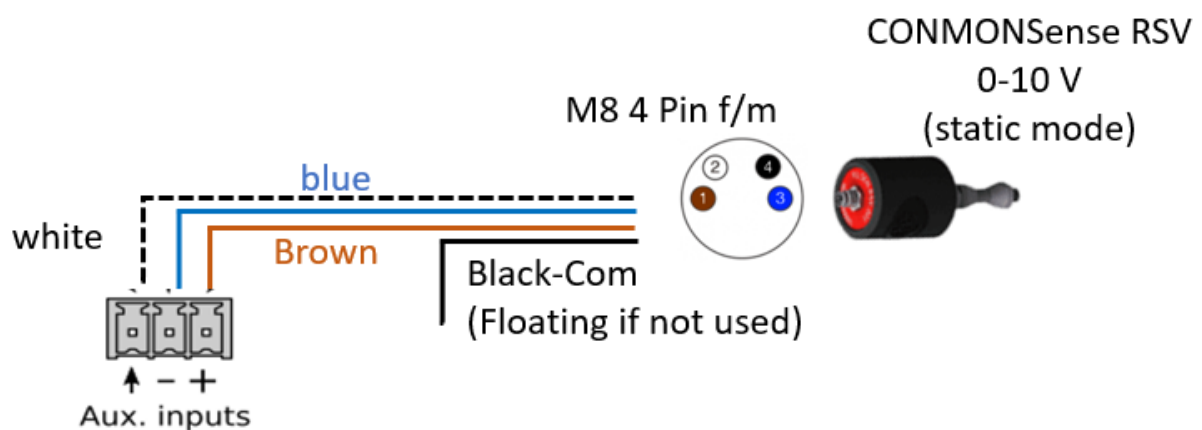

COMMONSense sensors are provided in a default configuration (dynamic mode, Gain = +60 dB)

The appropriate gain of the sensor as well as its operating mode must be adjusted during the installation using the communication line. SDT recommend using the configuration box to easily change these settings.

Each change must also be applied accordingly in the VIGILANT

Please refer to the datasheets of these sensors for further details



In static mode, COMMONSense sensors deliver a DC signal that is directly linked to the RMS

## 10. User Interface

This section describes the user interface of the *Vigilant* Machinery Supervisor.

### 10.1. Introduction

*Vigilant* comes with an embedded web-based user interface. It can be accessed from any operating system, including tablets and smartphones without any installation.

The user Interface allows to configure the unit, access its general settings, and visualize data. The interface is divided into 4 different components:

- *System*. Provides information about the status of the *Vigilant* and allows the user to configure its general settings.
- *Configuration*. Configures the different monitoring components of the *Vigilant* (inputs, sensors, processing modes, parameters, measuring points, alarms, etc.).
- *Dashboard*. This interface shows the data measured by the *Vigilant* unit.
- *Manual and preferences*. Shows the manual of the *Vigilant*.



It is strongly recommended to use Chrome or Mozilla Firefox as the web browser. The interface optimizes for both browsers. Other web browsers might not work correctly.

### 10.2. Access

The following steps describe the way to access the configuration interface. By default, the user interface will show the *Dashboard* application.

- Connect the *Vigilant* to your device or network using an Ethernet cable. A quick user installation guide is proposed with the unit.
- Find out the IP address of the unit. By default, the *Vigilant* is supplied with the following default IP address: 192.168.0.150 (or 10.8.2.150 via the mobility case from the 2<sup>nd</sup> ethernet port on the box).
- Change the IP address of your client PC or use DHCP mode on windows, so both are in the same logical Ethernet network (netmask: 255.255.255.0, gateway: 192.168.0.1 or 10.8.2.1 from the 2<sup>nd</sup> ethernet port, by default).

Note 1: You can also access the VIGILANT Mobility case via WIFI. Find out the SSID of your unit then enter the default WIFI password: *MQUdWNOM*

Note 2: The gateway (module RUT 240) is accessible at 10.8.2.1 (or 192.168.0.1):

User: admin, password: *SnE9qica*

**Contact your IT to integrate the unit to your existing network**

- Start your web browser and type the IP address of the *Vigilant* unit into the web address bar.
  - -at 192.168.150 (by default for the standalone version)
  - -at 10.8.2.150 (by default for the Mobility version)
  - -at the IP address assigned and configured by your IT dpt
- The browser will display the login box.

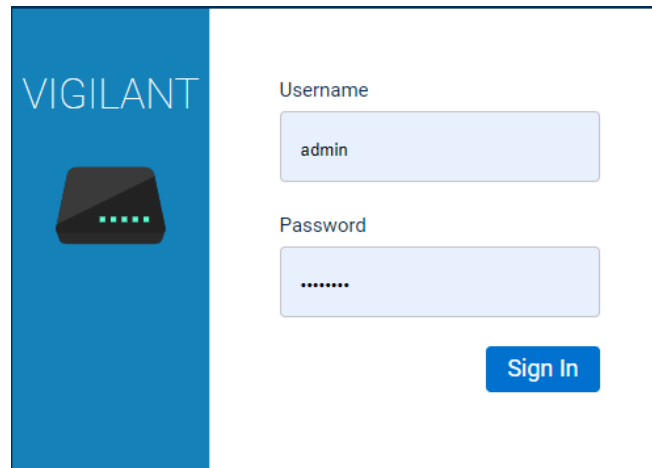

The login screen features a blue vertical banner on the left with the word "VIGILANT" at the top and a black device icon with four green status lights below it. To the right, there are two text input fields: "Username" containing the text "admin" and "Password" containing seven dots. A blue "Sign In" button is positioned below the password field.

Enter the username and password and click on “Sign in”. The Vigilant has a predefined Username assigned as “admin”. The default unique password is provided with the unit. Please refer to the documentation provided in the original package of the unit. The password is also printed on the label at the back of the unit.

### 10.3. Navigation bar

Once clicking Sign in, the following bar shows the navigation bar, the main toolbar for the User Interface and its components. It appears at the upper part of the web page and shares by all the different modules of the interface:

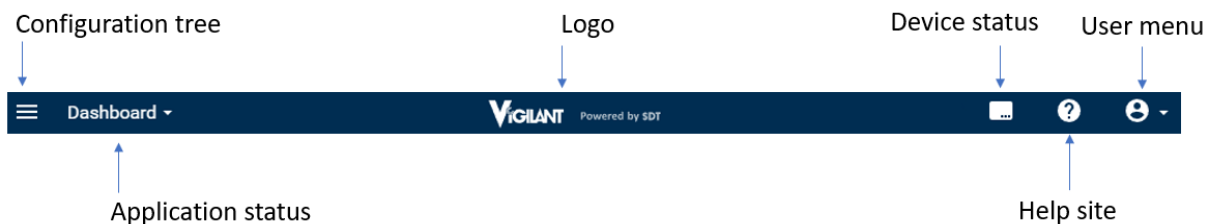

#### 10.3.1. Configuration tree

On the left of the navigation bar, you will see this button:



This button will show or hide, on the left of the screen, a panel with the configuration Tree.

In the main user interface, this structure will show the system’s measurement configuration. When instead of the Dashboard, shows Main Configuration or System Configuration, the button will have a similar behavior, in those cases showing or hiding their respective menu trees.

Below the *configuration tree* button, in the Dashboard, the application will show four colored circles, with a number inside. This is the [Alarm Toolbar](#). These circles represent the *active alarms* that the system is detecting at this moment. The numbers indicate the specific number of alarms of each type. The colors of the circles range from warning (yellow) to danger (red). If the numbers inside are above zero, the circles will shine brighter.

When the configuration tree is open, the alarm toolbar will be located above the configuration tree, in horizontal:



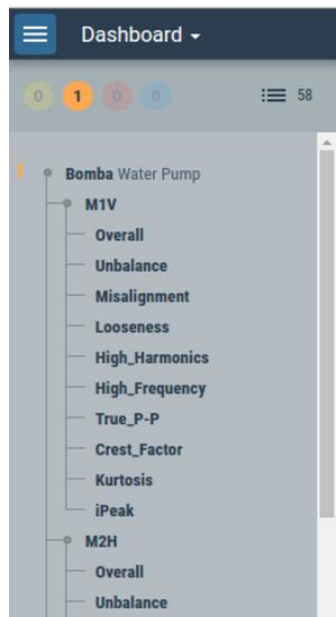



If the configuration tree is hidden, then the alarm toolbar will be located on the left, in vertical position:



The blue alarms relate to system alarm such as measurements that can be out of user-specifications. For example, this kind of alarms could be useful to indicate if the current measurement is beyond/above the specifications of the sensors.

An explicit message accompanying the alarm can also be displayed to identify what has been triggered and how to fix it.

Active Alarms		
Level	Source ▲	Value / Message
	M2:P5_channel5	Signal minimum is beyond sensor limit (-0.139 < 0.000)
	M2:P6_channel6	Signal minimum is beyond sensor limit (-0.625 < -0.418)

### 10.3.2. Interface Module

The navigation bar includes on the right of the *Configuration Tree* button the *Interface Module* menu. By clicking on it this pull-down menu will show the different interface modules. The module currently active will be listed at the top, and will be shown on the toolbar when this menu is closed.

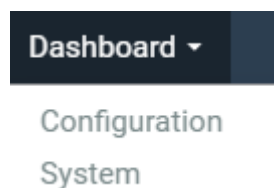

Selecting an item of the list will move the interface to the correspondent application. In the following chapters, you can read a detailed description of all the available applications.



The Dashboard application is shown by default when accessing the system.

### 10.3.3. Exception indicator

In case a warning system event or exception occurs, a red bell-shaped icon will appear at the upper-right part of the navigation bar. This icon indicates that the system has detected a system error or exception that requires some attention by the user:



By clicking on the icon, the interface will show a more detailed description of the specific event or exception. Usually, those warning events and exceptions refer to:

- Storage capability of the system is reaching its limit.
- Error or exception occurred while trying to store data.
- Other kind of internal error (undefined).

### 10.3.4. Special unit indicator



In some cases, an indicator with a blue background will appear in the top bar indicating that the application is not a regular Vigilant unit. This indicates that the VIGILANT is a special demonstrative unit, with all the licenses/features activated but not intended to be used in commercial applications.

### 10.3.5. Device status

On the right of the toolbar, the status summary button is displayed :

Clicking on it, a window will appear with information about the unit (serial number, hardware, and firmware versions).

Clicking *Full status info* will redirect you to the full status page of the system configuration that is also available in section System (See [Status](#)).

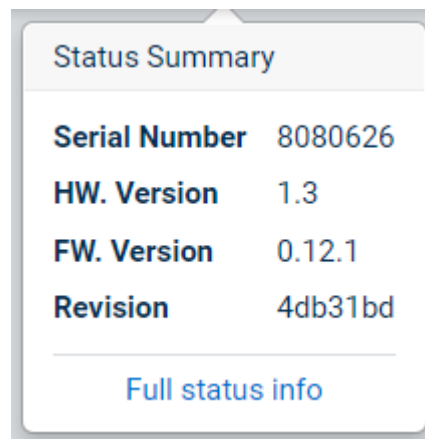

### 10.3.6. Help button

The *Help button*  opens the user manual, in a separated tab (in PDF format).



Please note that the user manual is not integrated in the VIGILANT. The Help button redirects to the user manual on SDT website which means that you will need to have direct internet connection.

Or, in case of local configuration, with no internet connection, you can download the latest version at:

<https://sdtultrasound.com/products/permanent-monitoring/vigilant/>

### 10.3.7. User Menu

The toolbar presents the *User Menu* at its right-hand side. The text of this menu shows the user currently logged in.



By clicking on this button to access the following options that are described in the table hereunder:

## Preferences

Export desktops

Import desktops

Rename tags

Logout

Menu option	Description
Preferences	Access to the specific preferences (language and units) for the active user.
Export desktops	Export a JSON file, in .dat format, containing the desktop layout configuration from the active user and unit preferences. Save the dashboard settings.
Import desktops	Import a JSON file.dat containing the desktop layout information and unit preferences. Load the dashboard settings.
Rename tags	This menu allows changing machine's tags from the active desktop configuration, such as adapting the widgets to the new name of the machines that may have been changed in the configuration.
Logout	Logout the current user and go back to the login page.

By clicking on the *Preferences* button, we will access to the following menu:

The screenshot shows the 'User preferences' dialog box. It contains the following elements:

- Full name\*:** A text input field containing 'Admin'.
- Language:** A dropdown menu currently set to 'English'.
- Units section:**
  - Two dropdown menus for 'Freq.' and 'Hz'.
  - An 'Add/Update' button.
  - A table with the following data:
 

Property	Unit	Action
Displacement	µm	Delete
Velocity	mm/s	Delete
Acceleration	G	Delete
- Buttons:** 'Cancel' and 'Accept' buttons at the bottom.

Field	Description
Full name	Defines the name that will be shown for this user on the interface.
Language	Selects the language in which the interface will be shown for that user. Additional languages will be progressively implemented using firmware updates. At the moment, the webserver interface is only available in English.
Units	Sets the user preferred units and other properties.

The *Units* form allows users to select specific units to be used when determinate properties are displayed in the [Dashboard](#). Properties that have not been configured in this menu will be displayed using the default (base) unit.

To add a new unit preference, select the left control property, and then the appropriate unit in the right control. Then, click on *Add/Update* to include it in the list, and it will be ready to be used as a preference. To modify properties that are already in the list, they must be previously deleted and then added again.

See section [Units](#) to add any magnitude or unit to the system.

## 10.4. Basic interface elements

The interface provides 2 different types of views: forms and lists.

### 10.4.1. Forms

Forms contain different fields where the user can introduce information, by writing free text or by selecting a predefined value from a pull-down list. Most of the time, these fields are organized in sections. The following picture shows an example of a form, in the configuration menu when browsing in Machine then clicking on New.

The screenshot shows a configuration form for a machine. The form is titled "Machine M1" and has "Cancel" and "Accept" buttons. The form contains several input fields:

- Tag\*: M1
- Enabled:
- Name: Centrifugal pump
- Description: Enter value of description
- Manufacturer: SDT International
- Model: 300 kW
- Serial number: 12452185
- Support class: Rigid
- Rated power: 300 kW
- Image: centrifugalpump.PNG

There is also a "Monitoring" section with the following fields:

- Enabled:
- Period: 5 s
- Delay at start-up: 0 s
- Buffer size: 262144 samples

Users can edit those fields inside a box that have a white background. Those fields with gray background or outside of a control box are just informative. The fields with an asterisk indicate that they must be filled in, otherwise the changes in the form will not be accepted and the system will return an error message.

After filling the required fields in the form, user can either save the changes or discard them, using the Accept or Cancel buttons.

Icon	Description
Accept	Saves the changes made on the form into the configuration database.
Cancel	Restores the value of the fields of the form to the previous values and exits the form.

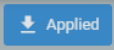

All the changes made on the different forms are stored automatically on the configuration database after clicking on the Accept button. However, they are not applied into the *Vigilant* until the  button from the toolbar is used.

Some fields are guided by a help text, in grey color and on the field itself, when it is blank. They typically show an example or a tip about how to introduce the information correctly.









Some forms provide direct links to configuration forms of different elements belonging to the item being configured. They are marked with a blue background.





Clicking on the button  will show the list for the corresponding type of component.



### 10.4.2. Lists

Lists provide a set of rows, which refer each of them to an item or object (machines, sensors, users, alarms, etc.). The following picture shows an example of a list of one of these elements. In this case the list shows the processing modes configured for a dynamic point of a machine/asset.

Tag	Name	Type	Frequency	
1kHz	1kHz	Spectrum/Wave	2 - 1000 Hz	  
20kHz		Spectrum/Wave	0 - 20000 Hz	  
iPeak		Demodulation	0 - 1000 Hz	  

Elements of the list can be edited by clicking on any of those. The interface will show some buttons that provide edit options, on the right end or at the bottom of the list (Move-up, Move-down, Delete, Copy, New, Import, etc.). The following table describes these options:

Icon	Description
	Moves the item of the list one position up.
	Moves the item of the list one position down.
	Deletes the item from the configuration database. A pop-up windows will ask for confirmation.

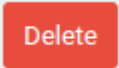
Copy	Copies the item selected and creates a new one with the same options. The interface will show a pop-up window, requesting some information about the new item (Tag, Name, etc.).
New	Creates a new item of the list and shows its configuration form.
Import	Imports an item from a different list into the current one. For example, it can copy a dynamic point from a point's lists of a different machine into the current one. A pop-up window will appear to select the copied from a different location and to introduce some information about the new item (Tag, Name, etc.).
Select file	A modal form enabling the user to select a local file.

The interface allows you to organize the lists using the *Move-up* and the *Move-down* buttons.

### 10.4.3. Expression Editors

Some components of the configuration interface are defined using expressions or formulas that allow to build flexible rules to define how the system behaves. In particular these expressions are used to define the value for the *Formula type* points and to evaluate the *Condition* field (*True* or *False*) on the configuration of the *Output connections*, *Machine states* and *Storage strategies*. They are also used to define the minimum and maximum frequencies of the *Spectral bands*, although with some limitations on the variables that can be selected.

These expressions are built using a text editor (see picture below) by combining variables and operators.

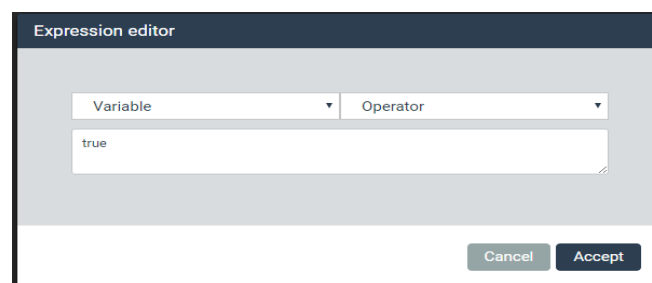

Expressions can be built using any of the variables included on the system and different logical operators. When these expressions are used to evaluate a *Condition* the system will return True (1) when the result of the expression is different from zero, and will return False (0) when the result is zero.

The *Expression Editor* provides a pull-down menu with the list of the available variables that can be used in the expressions. This list includes all the measurements configured on the unit, its alarm status, its error status and some internal variables (timers, speed change, load change, etc.). By selecting one of the items of the list the corresponding variable will be inserted automatically on the expression field, helping in that way with the writing of the expression.

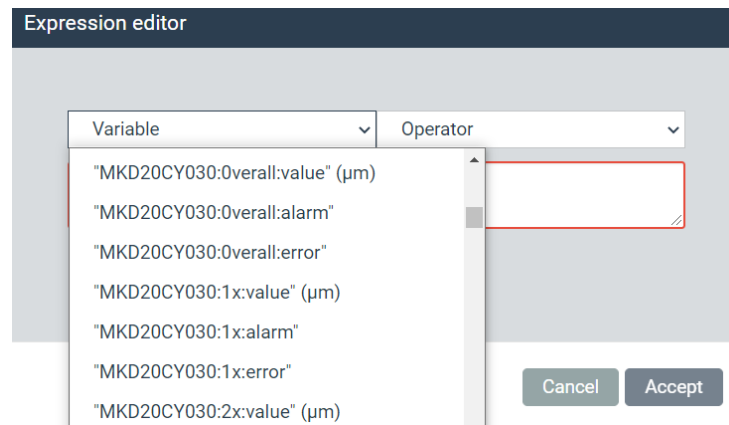

The editor also provides a pull-down menu with all the logical and arithmetic operators that can be included on the expression. By selecting one of the items of this list the corresponding operator will be inserted automatically on the expression field.

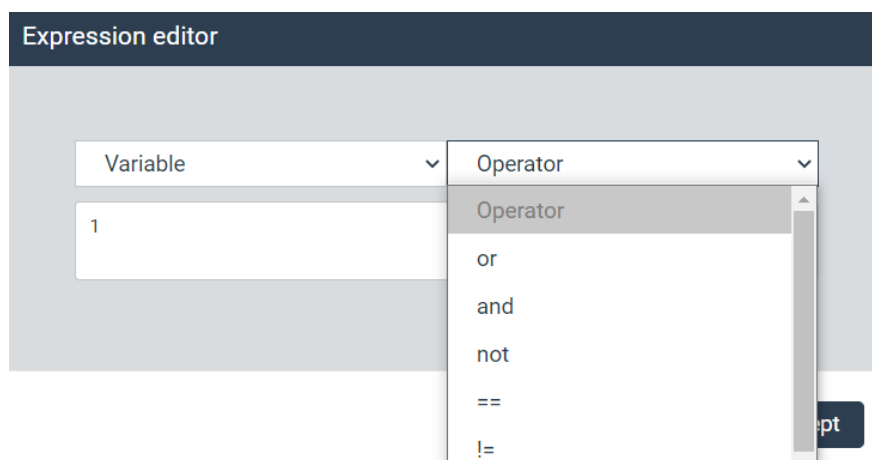

The system checks automatically if the syntax of the expression is correct. In case they are not the editor will show an "Invalid Expression" message.

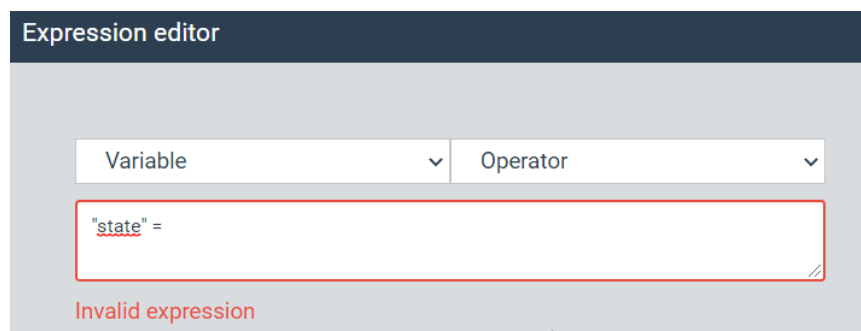

The following table shows the list variables available on the Expression Editor. In this table the text in cursive point\_tag, param\_tag and Pulse\_train\_point must be substituted by the tags of the corresponding points and parameters. These texts must be written always surrounded by double quotes on the expressions. The following lines show examples for Point\_tag:alarm, Point\_tag:param\_tag:alarm and Point\_tag:param\_tag:value.

- "B1V:alarm" provides the alarm value of point B1V.
- "B1A:alarm" provides the alarm value of point B1A.
- "B1H:RMS:alarm" provides the alarm value of the parameter RMS of point B1H.



- "B2V:RMS:value" provides the value of the parameter RMS of point B2V.
- "B2A:1x:value" provides the value of the parameter 1x of point B2A.

Variable	Description										
Speed	This variable provides the current speed value of the <i>Machine</i> in Hz units. It is defined by the <i>Tachometer</i> field of the <i>Machine</i> configuration, or <i>Rated speed</i> field in case that one is blank. Note that different <i>Points</i> in the same <i>Machine</i> may have different speed factors.										
Speed_change	This variable provides the speed change of the <i>Machine</i> in Hz units. It is calculated by the difference, in absolute value, between the current <i>Machine</i> speed measured by the unit and the last speed value stored in the database.										
Load	Returns the load value of the <i>Machine</i> . It is defined by the <i>Load point</i> field of the <i>Machine</i> configuration, or <i>Rated load</i> field in case that one is blank. When configured by the <i>Load point</i> the value will be provided on the default units for the corresponding property of the point. When configured by the <i>Rated Load</i> fields the value is provided in the units defined on the corresponding field.										
Load_change	Returns the load change of the <i>Machine</i> . It is calculated by the difference, in absolute value, between the current <i>Machine</i> load measured by the unit and the last load value stored in the database. When the load is configured by the <i>Load point</i> field the value will be provided on the default units for the corresponding property of the point. When configured by the <i>Rated Load</i> fields the value is provided in the units defined on the corresponding field.										
State	This variable provides the index number of the current <i>State</i> of the <i>Machine</i> . The index number can be shown on the list of <i>States</i> of the <i>Machine</i> under the <i>Number</i> label. <table border="1" data-bbox="624 1122 1187 1267"> <thead> <tr> <th>Name</th> <th>Number</th> </tr> </thead> <tbody> <tr> <td><a href="#">Stopped</a></td> <td>0</td> </tr> <tr> <td><a href="#">Running</a></td> <td>1</td> </tr> </tbody> </table>	Name	Number	<a href="#">Stopped</a>	0	<a href="#">Running</a>	1				
Name	Number										
<a href="#">Stopped</a>	0										
<a href="#">Running</a>	1										
Alarm	Returns the value associated with the alarm condition of the <i>Machine</i> . The alarm condition is set as the worst alarm status of any of its measurements. The following table shows the values associated with the different alarms. <table border="1" data-bbox="746 1440 1075 1664"> <thead> <tr> <th>Alarm</th> <th>Value</th> </tr> </thead> <tbody> <tr> <td>Ok</td> <td>0</td> </tr> <tr> <td>Warning</td> <td>1</td> </tr> <tr> <td>Alert</td> <td>2</td> </tr> <tr> <td>Danger</td> <td>3</td> </tr> </tbody> </table>	Alarm	Value	Ok	0	Warning	1	Alert	2	Danger	3
Alarm	Value										
Ok	0										
Warning	1										
Alert	2										
Danger	3										
Error	This variable is set to 0 when no errors are detected on the captures or any of the measurements of the <i>Machine</i> , and a number different than 0 otherwise. See <a href="#">Error codes</a> .										
gError	This variable stands for "global Error" and returns the worst error condition found on any of the subcomponents that belong to the one this variable applies to. See <a href="#">Error codes</a> .										
t	Returns the UNIX timestamp at which the current snapshot was captured.										
Elapsed_t	This internal variable provides the number of seconds elapsed since the last stored snapshot was captured. The value is initialized to 0 at startup or after a new configuration is applied.										

t_st (x)	This variable provides the number of seconds spent by the <i>Machine</i> in that state since restart or since the last change made on the configuration. The “x” denotes the ID number of a <i>Machine</i> state.																
e_st (x)	<p>The unit creates for each <i>Machine</i> as many of these variables as <i>Machine</i> states. Each of them is identified as the “e_st” plus the <i>State</i> index number. This identifier number is shown on the <i>Machine</i> state list.</p> <table border="1" data-bbox="630 405 1187 551"> <thead> <tr> <th>Name</th> <th>Number</th> </tr> </thead> <tbody> <tr> <td><a href="#">Stopped</a></td> <td>0</td> </tr> <tr> <td><a href="#">Running</a></td> <td>1</td> </tr> </tbody> </table> <p>For each <i>Machine</i> status, these variables provide the time elapsed in seconds between the current <i>Machine</i> capture measured on the unit and the last one stored in the database with the <i>Machine</i> in that <i>State</i>. For example, the variable “e_st1” provides the time elapsed between the last capture measured and the last one stored in the database with the <i>Machine</i> in state 1 (<i>Running</i> on the example above).</p>	Name	Number	<a href="#">Stopped</a>	0	<a href="#">Running</a>	1										
Name	Number																
<a href="#">Stopped</a>	0																
<a href="#">Running</a>	1																
e_str (x)	<p>The unit creates for each <i>Machine</i> as many of these variables as <i>Machine</i> storage strategies. Each of them is identified as the “e_str” plus the <i>Storage</i> strategy index number. This identifier is shown on the <i>Storage</i> strategies list.</p> <table border="1" data-bbox="485 999 1326 1178"> <thead> <tr> <th>Name</th> <th>Number</th> <th>Event</th> <th></th> </tr> </thead> <tbody> <tr> <td><a href="#">Parameters</a></td> <td>0</td> <td>Time period</td> <td>Every 30 minutes</td> </tr> <tr> <td><a href="#">Spectra</a></td> <td>1</td> <td>State change</td> <td>-</td> </tr> <tr> <td><a href="#">Stopped</a></td> <td>2</td> <td>Time period</td> <td>Every 24 hours</td> </tr> </tbody> </table> <p>For each <i>Storage</i> strategy, these variables provide the time elapsed in seconds between the current <i>Machine</i> capture measured by the unit and the last one stored in the database caused by the corresponding <i>Storage</i> strategy. For example, the variable “e_str1” provides the time elapsed between the last capture measured and the last one stored in the database that was caused by the <i>Storage</i> strategy 1 (<i>Spectra</i> on the example above).</p>	Name	Number	Event		<a href="#">Parameters</a>	0	Time period	Every 30 minutes	<a href="#">Spectra</a>	1	State change	-	<a href="#">Stopped</a>	2	Time period	Every 24 hours
Name	Number	Event															
<a href="#">Parameters</a>	0	Time period	Every 30 minutes														
<a href="#">Spectra</a>	1	State change	-														
<a href="#">Stopped</a>	2	Time period	Every 24 hours														
Point_tag:Alarm	This type of variable provides the value associated with the alarm condition of the <i>Point</i> . The alarm condition is set as the worst alarm status of any of its measurements. The values associated with the different alarms are the same as for the “Alarm” variable described on the previous page (Ok:0, Warning:1, Alert:2, Danger:3).																
Point_tag>Error	This type of variable returns 0 when no errors are detected on the captures or any of the measurements of the <i>Point</i> , and a positive integer number different from 0 otherwise. These variables indicate that an error has occurred while measuring or processing any of the measurements of the <i>Point</i> . See <a href="#">Error codes</a> .																
Point_tag:gError	Returns the worst error code of any of the sub-components of the <i>Point</i> (processing modes, parameters, etc.). Possible values are: <ul style="list-style-type: none"> <li>• 0: No error</li> <li>• Other positive integer value: An error has been detected. See <a href="#">Error codes</a>.</li> </ul>																

<i>Point_tag:vbias</i>	Provides the value of the Bias or DC voltage of the input channel that was configured for that <i>Point</i> .
<i>Point_tag:parameter_tag:value</i>	This type of variable provides the value of the corresponding <i>Parameter</i> of the <i>Point</i> .
<i>Point_tag:parameter_tag:alarm</i>	This type of variable provides the value associated with the alarm condition of the corresponding <i>Parameter</i> . The values associated with the different alarms are the same as for the “Alarm” variable described on the previous page (Ok:0, Warning:1, Alert:2, Danger:3).
<i>Point_tag:parameter_tag:error</i>	This type of variable returns 0 when no error is detected when measuring the <i>Parameter</i> , and a positive integer number different from 0 otherwise. As an example, values outside the validation range sets this variable to an integer value higher than 0. See <a href="#">Error codes</a> for more information.
<i>Point_tag:parameter_tag:peak</i>	Provides the peak value of a <i>Peak-phase Parameter</i> .
<i>Point_tag:parameter_tag:phase</i>	Provides the phase value of a <i>Peak-phase Parameter</i> in degrees.
<i>Pulse_train_point:freq:value</i>	Provides the frequency value of the corresponding <i>Pulse train Point</i> in Hz units.
<i>Pulse_train_point:freq:alarm</i>	Provides the value associated with the alarm condition of the corresponding <i>Pulse train</i> frequency measurement. The values associated with the different alarms are the same as for the “Alarm” variable described on the previous page (Ok:0, Warning:1, Alert:2, Danger:3).
<i>Pulse_train_point:freq:error</i>	This type of variable is set to 0 when no error is detected associated with frequency measurement of the corresponding <i>Pulse train Point</i> . and provides a positive integer number different from 0 otherwise. As an example, frequency value outside the validation range sets this variable to an integer value higher than 0. See <a href="#">Error codes</a> for more information.
<i>Pulse_train_point:freq_span:value</i>	This variable provides the frequency span in Hz of the <i>Pulse train Point</i> . Frequency span is defined as the difference, in absolute value, between the maximum and minimum values measured on the corresponding <i>Pulse train</i> frequency during the sampling time of the <i>Machine</i> capture. The sampling time of the capture is set by the acquisition mode with the higher sampling time requirement of all the different <i>Points</i> of the <i>Machine</i> . As an example, an acquisition mode with a spectrum defined with an Fmax of 1 kHz, 1.600 lines of resolution, 10 averages and 67% overlap requires a sampling time of 6.4 seconds, and let’s assume this is the longest sampling time required for all the acquisition <i>Points</i> of the <i>Machine</i> . The <i>freq_span</i> variable would get the value of the maximum and minimum frequency value of the <i>Pulse train Point</i> measured during the 6.4 seconds of sampling time.
<i>Pulse_train_point:freq_span:alarm</i>	...
<i>Pulse_train_point:freq_span:error</i>	...
True	Provides a value of 1 or <i>True</i> to those expressions that define a condition.

False	Provides a value of 0 or <i>False</i> to those expressions that define a condition.
e	Provides the value of the mathematical <i>e</i> number.
Pi	Provides the value of the mathematical <i>PI</i> number.
$\pi$	Provides the value of the mathematical $\pi$ number.



*Alarm codes are propagated from the parameters to the point, and from the points to the machine, so that the alarm code of an element reflects the worst case of its children's alarms.*

The following table shows the list operators available on the Expression Editor.

Operator	Description
Or	The <i>Or</i> operator is a Boolean operator which returns the value TRUE or Boolean value of 1 if either or both operands are TRUE or have Boolean value of 1, and returns FALSE or Boolean value of 0 otherwise.
And	The <i>And</i> operator is a Boolean operator which returns the value TRUE or Boolean value of 1 only if both operands are TRUE or have Boolean value of 1, and otherwise returns FALSE.
Not	The <i>Not</i> operator is a Boolean operator that returns TRUE or 1 when the operand is FALSE or 0, and returns FALSE or 0 when the operand is TRUE or 1.
==	The equal-to operator (==) returns TRUE if the operands have the same value, and it returns FALSE otherwise.
!=	The not-equal-to operator (!=) returns TRUE if the operands don't have the same value, and it returns FALSE otherwise.
>=	The greater-than or equal-to operator returns TRUE if its left-hand operand is greater than or equal to its right-hand operand and it returns FALSE otherwise.
<=	The less-than or equal-to operator returns TRUE if its left-hand operand is less than or equal to its right-hand operand and it returns FALSE otherwise.
>	The greater-than operator returns TRUE if its left-hand operand is greater than its right-hand operand and it returns FALSE otherwise.
<	The less-than operator returns TRUE if its left-hand operand is less than its right-hand operand and it returns FALSE otherwise.
-	The <i>Subtraction</i> (-) operator provides the mathematical result of subtracting the number at the right side of the operator from the one at its left side.
+	The <i>Sum</i> (+) operator provides the mathematical result of adding the numbers (addends) at the left and right side of the operator.
*	The <i>Multiply</i> (*) operator provides the mathematical result of multiplying the numbers at the left and right side of the operator.
**	The <i>Power</i> (**) operator provides the mathematical result of raising the number at the left-side of the operator to the power of the number at the right-side.
/	The <i>Division</i> (/) operator provides the mathematical result of dividing the numbers at the left side of the operator by the number at its right side.
%	The <i>Modulus</i> (%) operator provides the remainder of dividing the number at the left side of the operator by the number at its right side.

(	<p>The <i>Open parenthesis</i> symbol defines the start of the grouping of a part of the expression. The corresponding sub-expression contained within the parenthesis takes precedence over those surrounding it and will therefore be evaluated first. The system admits nested parentheses.</p> <p>You can surround a subexpression with parentheses to indicate a higher precedence order in evaluating the full expression.</p>
)	<p>The <i>Closed parenthesis</i> symbol defines the end of the grouping of a part of the expression. The corresponding sub-expression contained within the parenthesis takes precedence over those surrounding it and will therefore be evaluated first. The system admits nested parentheses.</p>
abs	<p>The <i>Abs</i> operator returns the absolute (positive) value of a number or result of an expression. That number or expression must be enclosed in brackets after the <i>Abs</i> operator (e.g. <i>Abs (-1)</i>, <i>Abs(a+b)</i> ).</p>
sqrt	<p>Returns the square root of a number or result of an expression. That number or expression must be enclosed in brackets after the <i>Sqrt</i> operator (e.g. <i>Sqrt (9)</i>, <i>Sqrt(a+b)</i> ).</p>
log	<p>Returns the 10 base logarithm of a number or result of an expression. That number or expression must be enclosed in brackets after the <i>Log</i> operator (e.g. <i>Log(9)</i>, <i>Log(a+b)</i> ).</p>
ln	<p>Returns the natural logarithm or <i>e</i> base logarithm of a number or result of an expression. That number or expression must be enclosed in brackets after the <i>Ln</i> operator (e.g. <i>Ln(9)</i>, <i>Ln(a+b)</i> ).</p>
sin	<p>Returns the sine of a number or result of an expression. That number or expression must be enclosed in brackets after the <i>Sin</i> operator (e.g. <i>sin(9)</i>, <i>sin(a+b)</i> ). The function assumes that the number or result of the expression enclosed in brackets is in <i>Radian</i> units.</p>
cos	<p>Returns the cosine of a number or result of an expression. That number or expression must be enclosed in brackets after the <i>Cos</i> operator (e.g. <i>cos(9)</i>, <i>cos(a+b)</i> ). The function assumes that the number or result of the expression enclosed in brackets is in <i>Radian</i> units.</p>
tan	<p>Returns the tangent of a number or result of an expression. That number or expression must be enclosed in brackets after the <i>Tan</i> operator (e.g. <i>tan(9)</i>, <i>tan(a+b)</i> ).</p>
asin	<p>Returns the arcsine of a number or result of an expression in <i>Radians</i> units. That number or expression must be enclosed in brackets after the <i>Asin</i> operator (e.g. <i>asin(9)</i>, <i>asin(a+b)</i> ).</p>
acos	<p>Returns the arc cosine of a number or result of an expression in <i>Radians</i> units. That number or expression must be enclosed in brackets after the <i>Acos</i> operator (e.g. <i>acos(9)</i>, <i>acos(a+b)</i> ).</p>
atan	<p>Returns the arc tangent of a number or result of an expression. That number or expression must be enclosed in brackets after the <i>Atan</i> operator (e.g. <i>atan(9)</i>, <i>atan(a+b)</i> ).</p>
sinh	<p>Returns the hyperbolic sine of a number or result of an expression. That number or expression must be enclosed in brackets after the <i>Asin</i> operator (e.g. <i>sinh(9)</i>, <i>sinh(a+b)</i> ). The function assumes the number, or result of the expression, is in <i>Radian</i> units.</p>

cosh	Returns the hyperbolic cosine of a number or result of an expression. That number or expression must be enclosed in brackets after the <i>Cosh</i> operator (e.g. <i>cosh(9)</i> , <i>cosh(a+b)</i> ). The function assumes the number, or result of the expression, is in <i>Radian</i> units.
tanh	Returns the hyperbolic tangent of a number or result of an expression. That number or expression must be enclosed in brackets after the <i>Tanh</i> operator (e.g. <i>tanh(9)</i> , <i>tanh(a+b)</i> ).
asinh	Returns the hyperbolic arcsine of a number or result of an expression in <i>Radians</i> units. That number or expression must be enclosed in brackets after the <i>Asinh</i> operator (e.g. <i>asinh(9)</i> , <i>asinh(a+b)</i> ).
acosh	Returns the hyperbolic arc cosine of a number or result of an expression in <i>Radians</i> units. That number or expression must be enclosed in brackets after the <i>Acosh</i> operator (e.g. <i>acosh(9)</i> , <i>acosh(a+b)</i> ).
atanh	Returns the hyperbolic arctangent of a number or result of an expression. That number or expression must be enclosed in brackets after the <i>Atanh</i> operator (e.g. <i>atanh(9)</i> , <i>atanh(a+b)</i> ).



*All the values for the system variables are returned in the default units, not taking into consideration user settings (e.g. m/s<sup>2</sup>, m, A, Hz). The pull-down menu shows the units that will be used for each variable.*



*By selecting a variable or operator on the Expression editor it will be inserted automatically on the expression field, helping on its writing.*



*When evaluating conditions, a resulting value from the expression different of 0 is equivalent to True. A resulting value equal to 0 is equivalent to False. It is also possible to include False or True words as part of the expression, which take a value of 0 and 1, respectively.*

Here are some examples of typical logical expressions:

Expression	Condition to be True
<code>("speed" &gt; 10) and ("state" &gt; 0)</code>	Speed is greater than 10 Hz and the state is not "default".
<code>("speed" &gt; 10) and ("speed" &lt; 20)</code>	The speed of the machine is between 10 and 20 Hz.
<code>("speed_change" &gt; 10) and not "error"</code>	There has been an increase in more than 10 Hz of speed since the last record, and the system is not detecting any measurement error.
<code>"elapsed_t" &gt;= 60</code>	At least 60 seconds have passed since the last stored snapshot.

#### 10.4.4. How to create conditional expressions

The syntax used for the logical expressions allows the creation of conditional formulas type *if...then...else*, even though such operators do not exist directly.

To do this, first you must consider that the expressions that are evaluated to be True take the numerical value 1, and the False ones take value 0. Besides, you must also take into account the following conditions:

- In an "or" comparison, if the first operator is evaluated to have a value of 0, then it is no longer necessary to evaluate the second operator.
- With the "and" operator it works in the opposite way. If the first operand is evaluated to be 0, then the second operand is no longer evaluated.

With all of that in mind, it is easy to generate concatenated expressions of the type "if ... else if ... else". For example, consider this expression:

```
val1*(rms < 0.1) or val2*(rms < 0.5) or val3
```

Its logic would be equivalent to this one:

```
if (rms < 0.1)
    return val1
else if (rms < 0.5)
    return val2
else
    return val3
```

# 11. System Settings



## 11.1. Introduction

The System Settings interface provides information about the status of the *Vigilant unit*, and allows the user to configure some properties related to system administration, connectivity, data storage, user management, etc.

## 11.2. Menu Tree

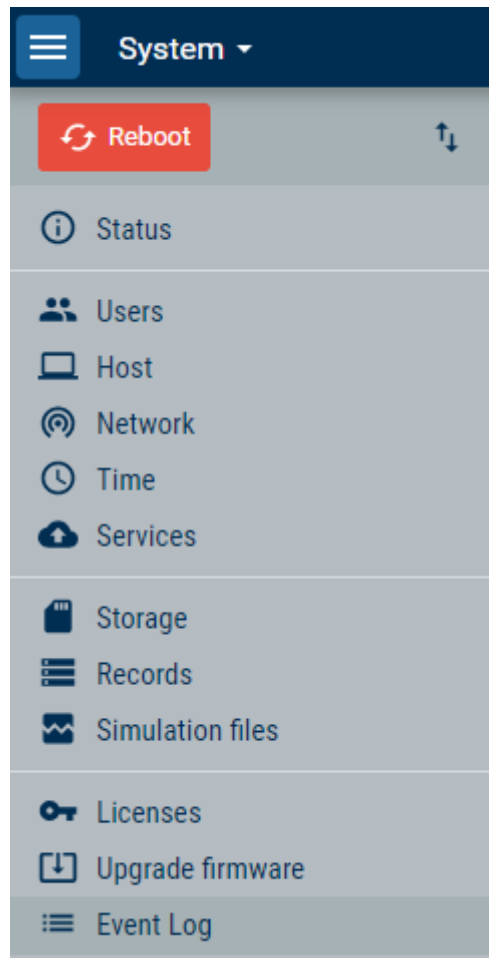
On the left-hand side of the interface, a vertical menu shows the different system settings options available.



Icon	Description
	This button reboots the unit. After clicking on it a modal window will ask the user to confirm or cancel the action.
	This button provides access to the <a href="#">Export/Import</a> tools. These tools allow users to restore the last applied <i>Monitoring</i> and <i>System</i> configuration settings of the unit or to the factory settings. They also allow to export the <i>Monitoring</i> and <i>System</i> configurations into a file, or to import them from a previously exported one.



	<div style="display: flex; flex-direction: column; gap: 10px;"> <div style="display: flex; align-items: center;"> <div style="background-color: #f9a825; padding: 5px 10px; border-radius: 3px;">Restore</div> <div>Restore last applied main configuration. <b>The current one will be lost</b></div> </div> <div style="display: flex; align-items: center;"> <div style="background-color: #e53935; padding: 5px 10px; border-radius: 3px;">Clear</div> <div>Clear main configuration. <b>The current one will be lost</b></div> </div> <div style="display: flex; align-items: center;"> <div style="background-color: #1a3d4d; color: white; padding: 5px 10px; border-radius: 3px;">Export</div> <div>Export current main configuration to file</div> </div> <div style="display: flex; align-items: center;"> <div style="background-color: #1a3d4d; color: white; padding: 5px 10px; border-radius: 3px;">Import</div> <div>Import main configuration from file</div> </div> </div>
Status	Show general information about the unit and its status.
Users	Allow the administration of the users within the system.
Host	Define the network information about the unit, including name and description.
Network	Configure the network interface.
Time	Sets the date and time of the unit. This can be done by synchronizing the unit with a NTP server or with the local computer.
Services	Enable and configure several network services: Remote technical support and Email notifications
Storage	Shows the status of the SD card and allows it to format it. It configures the type of erasing strategy when the card reaches its limit. It also allows the system to disable the storage on the card.
Records	Provides information about the data blocks and records stored in the unit for each machine and allows it to erase them within a time range. It also allows the user to rebuild the database from the data blocks or records stored.
Backup	Shows the list of the remote backups available. The <i>Remote Backup</i> service must be enabled for this menu to show any data.
Simulation files	Allows loading and managing simulation archives, which are special data (.WAV) used to simulate machine vibration files.
Bearing files	Allows uploading spreadsheet files with lists of bearings, to be added to the device's database.
Licenses	Shows a list with all the different activated modules of the <i>Vigilant</i>
Upgrade firmware	Shows the firmware version and check if a new firmware is available.
Event Log	Shows in real time the internal events occurring in the system.

The following chapters describe in detail each of these options.

### 11.3. Status

This form shows the status of the *Vigilant* unit and provides additional general information.



## Status

Name: VIGILANT  
 Description: VIGILANT vibration analyzer  
 Serial: 8080289  
 Model: VIGILANT-L  
 Hardware version: 1.2  
 Firmware version: 1.1.6

MAC address: ██████████  
 Using DHCP: false  
 IP address: ██████████  
 Gateway: 10.8.2.1  
 Network mask: 255.255.255.0

Input voltage: 23.4 V  
 Battery voltage: 4.1 V  
 Board temperature: 47.5 °C  
 CPU temperature: 57.1 °C

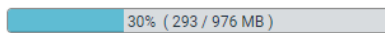
UTC Time: 15/09/2022 12:58:34  
 Local time: 15/09/2022 14:58:34  
 Uptime: 8d 12h 38m 47s  
 Configuration applied at: 08/09/2022 17:16:09

RAM:  30% ( 293 / 976 MB )  
 Storage:  73% ( 2750 / 3736 MB )  
 Records:  96% ( 9628 / 10000 )

Field	Description
Name	Shows the name of the unit assigned by the user on the <i>Host</i> configuration form (see <i>Host chapter</i> ).
Description	Description of the unit as configured by the user on the <i>Host</i> configuration form (see <i>Host chapter</i> ).
Serial	The serial number identifies the unit. This identifier is set up at the factory and cannot be changed by the user.
Model	Shows the model of the <i>Vigilant</i> unit.
Hardware version	This field shows the version of the hardware.
Firmware version	This field shows the version of the firmware installed on the unit.
Hostname	Shows the identifier that the device will have when trying to access it in the local network.
MAC Address	The MAC (Media Access Control) address is the unique hardware number that the instrument will use when connecting to an Ethernet network.
Using DHCP	Indicates if the device is using a fixed IP address (set by user) or if it is using an external DHCP server to get one.

IP Address	Indicates the Internet Protocol v4 address the device is using.
Gateway	Indicates the IP address of the network node from which the instrument is connected to the Internet.
Network mask	A netmask is a 32-bit mask used to divide an IP address into subnets and specify the network's available hosts.
Input Voltage	Shows the external power voltage provided to the unit.
Battery Voltage	Shows the voltage provided by the internal battery of the unit.
Board Temperature	Informs the current temperature present on the motherboard. Normal temperatures range up to 55°C.
CPU Temperature	Informs the current temperature of the main processor (CPU). Normal temperatures range up to 65°C.
UTC Time	Shows the UTC date and time configured on the unit. They can be changed on the Time settings (see <i>Time</i> ).
Local Time	Shows the local date and time. The unit reads the location from the device that shows the interface.
Uptime	This field indicates the time elapsed since the <i>Vigilant</i> unit was turned on.
Configuration applied at	This field indicates the date and time when the last configuration was applied in the unit.
RAM	Shows the percentage of RAM which <i>Vigilant</i> unit is currently using.
Storage	Shows the storage capacity the unit is currently using and its percentage related to the total available.
Records	Shows the number of <a href="#">Records</a> stored at the unit for a machine and its percentage related to the maximum available (10.000 for each machine). In case there are more than one machine configured it shows only the data of the worst case.

## 11.4. Users

This form displays a list of users who have access to the web interface.

The screenshot shows a 'Users' management interface. It features a table with the following data:

Username	Full name	Role	Actions
<a href="#">admin</a>	Admin	admin	Copy Export Import
<a href="#">jeff</a>	Jeff Martin	admin	Delete Copy Export Import
<a href="#">pepe</a>	Pepe Carro	viewer	Delete Copy Export Import
<a href="#">Bob</a>	esponja	viewer	Delete Copy Export Import
<a href="#">Cummings</a>	Peter Cummings	analyst	Delete Copy Export Import

At the bottom left of the interface, there is a 'New' button.

Clicking on one of the usernames (with the appropriate privilege) a new form will allow editing the user options:

The screenshot shows a form titled "User Admin1". It contains the following fields:

- Username\***: A text input field containing "admin".
- Full name\***: A text input field containing "Admin1".
- Language**: A dropdown menu with "English" selected.
- Change password**: A checkbox that is currently unchecked.

At the bottom right of the form are two buttons: "Cancel" and "Accept".

Click on  button to create a new user.

The screenshot shows a form titled "New user". It contains the following fields:

- Username\***: A text input field with placeholder text "Enter value of username f".
- Full name\***: A text input field with placeholder text "Enter value of full name fi".
- Role**: A dropdown menu with "Guest" selected.
- Language**: A dropdown menu with "English" selected.
- Password**: A text input field with placeholder text "Enter value of password fi".
- Repeat password**: A text input field with placeholder text "Enter value of repeat pass".

At the bottom right of the form are two buttons: "Cancel" and "Accept".

Field	Description
Username	Sets the user identification name. It must be unique within the system.
Full Name	Defines the full name of the user.
Role	<p>The role defines the user rights within the <i>Vigilant</i> unit. These are the available roles:</p> <ul style="list-style-type: none"> <li>• <i>Administrator</i>. This role allows the user to modify any configuration of the system and acknowledge and remove alarms.</li> <li>• <i>Analyst</i>. This role allows the user to acknowledge and remove alarms. It also allows users to edit the <i>Machine Configuration</i>, but not to change the <i>System Settings</i> options.</li> <li>• <i>Guest</i>. This role allows the user to acknowledge and remove alarms. It also allows the user to view the data captured by the device and see its <i>Configuration</i> and <i>System Settings</i>. It does not allow the user to make any modifications on those settings but allows them to make changes on the <i>Dashboard</i> interface, configuration of its <i>Widgets</i> and its layout.</li> <li>• <i>Viewer</i>. This role is the simplest. The users with this role are not allowed to access the <i>System</i> and <i>Configuration</i> interfaces. They are not allowed</li> </ul>

	<p>either to make permanent changes in the <i>Dashboard</i> interface or on the layouts of the <i>Widgets</i>.</p> <p>All roles allow the users to access the dashboard interface and change the layouts of the <i>Widgets</i>.</p> <p>By default, the dashboard of a new user is empty. Each new user needs to redefine the dashboard or import one from another user (see 10.3.7)</p>
Language	Sets the language of the interface for the user.
Change Password	Allows to change the password when marked this check box.
Password	Sets the password of the user.
Repeat password	Repeats the password for confirmation.



Only users with *Administrator* role will be able to modify the *Users* options.

Clicking on the *Delete* button will delete the user. The interface will ask for confirmation.

Clicking on the *Copy* button the corresponding user configuration will be copied. A window will appear asking about the name of the new user that will be created.

Do you want to copy this element? Please enter a new username

Cancel
OK

After entering the name of the new user, and pressing on the *OK* button, the new user will be created with the user configuration previously copied.

The *Export* and *Import* buttons on the *Users* form allow exporting the user preferences and *Dashboard* layout to an external file, and then reusing these settings for another user. This is particularly useful, for example, when creating a new *Viewer* role-type user: this type of user is not able to configure the layout of the *Dashboard* by itself, so it is necessary to copy the preferences of another user when creating a new *Viewer* user.

## 11.5. Host

Defines the name and description and hostname of the *Vigilant* unit. The user can change them to correctly identify the unit.

Label	Configuration tool
Name	This field allows the user to define a name for the <i>Vigilant</i> unit. Use a unique name within your network.
Description	Sets a user-defined description of the unit.

## 11.6. Network

This form allows the user to configure the Ethernet interface of the *Vigilant* unit.

Field	Description
Static	Allows the user to configure the static IP address of the <i>Vigilant</i> . If not checked the <i>Vigilant</i> unit will try to get its IP using DHCP protocol.
Address	Configures the IP address of the unit.
Network Mask	Sets the network mask, which is a 32-bit mask used to divide the IP address into subnets and specify the network's available hosts (define the subnet).
Gateway	Sets the network gateway. This may be the computer that controls the network traffic in your company network, or also the device provided by your internet service providers (ISP) to give you access to the internet.
DNS1	Defines the primary DNS server. It is the job of the DNS to convert the host names to the IP addresses of the web servers.
DNS2	Defines the secondary DNS address.

This menu is basic to set up the device and be able to access it in the future.



If you are not sure about the meaning of any of these terms, it is recommended to contact your IT service or your ISP provider.

## 11.7. Time

Shows the date and time of the unit and allows the user to change its configuration.

The system can be configured to synchronize its time/date in real time with a NTP Server. This requires the corresponding [Network Ports](#) to be open within the network. Network Time Protocol (NTP) is a networking protocol for clock synchronization between computer systems over packet-switched, variable-latency data networks.

The time/date of the unit can also be updated by synchronizing it with the local device from which the user is viewing the configuration interface.

## Time configuration

Restore
Apply

Time 15/07/2021, 15:31 NTP Sync

Enable NTP

NTP Server\* pool.ntp.org Test NTP

Label	Configuration tool
Time	Shows the date and time set on the unit.
Enable NTP	Enables the time synchronization with a NTP server.
NTP Server	Defines the address of the NTP server. This field appears only if “ <i>Enable NTP</i> ” checkbox has been marked.
NTP Sync	Synchronizes the time of the unit with the NTP server.
Test NTP	This button provides a connection test with the NTP server. Only appears if “ <i>Enable NTP</i> ” checkbox has been marked.
Local Sync	Synchronizes the time of the unit with the time of the computer or device where the user interface is shown. This button is only shown when the “ <i>Enable NTP</i> ” checkbox is unchecked.

## 11.8. Services

This section allows configuring the 2 types of services that the Vigilant integrated: Remote Technical Support and E-mail Notifications.

## Services

Restore
Apply

### Remote Technical Support

Enable

Terms of Service [Read Terms](#)

I accept above terms

---

### E-mail notifications

Enable



Some of these services require special network configurations, specifically the *Vigilant* must have access to [certain Network Ports](#). Ask your IT or your ISP provider to check if communication through those ports is available.

### 11.8.1. Remote technical support

Currently, the system only enables the possibility to create backups in the **Vigilant** network. This service guarantees the user a higher level of security about the integrity of its measurement data. Whenever it is needed, user can access this service

### 11.8.2. Email notifications

Enable	<input checked="" type="checkbox"/>
SMTP Server	Custom
Host	smtp.gmail.com
Port	25
Security Policy	SSL/TLS
Authentication Policy	Login
User	myusere
Password	..... <input type="checkbox"/>
Notify errors	<input type="checkbox"/>
Alarm level	Alert
Email addresses	test@gmail.com <input type="button" value="Send email"/>
Custom message	Test email

The *Email Notifications* service allows sending emails to a set of contacts, specified by the user, every time a condition is met. That condition may be a specific alarm level (generic for all the machines defined in *Configuration*) or an error in the system. Users can customize emails with a user-defined message.

This *E-mail notifications* form includes the possibility of sending a test email to verify that the email addresses and the network configuration are correct.

Field	Description
Enable	Enables the notifications service. When checked, the form shows the rest of the parameters for this service.
SMTP Server	Select which email server to use for the notifications. In case of selecting <i>Default</i> , the <b>Vigilant</b> server will be used, and most of following fields will not be necessary.
Port	Usually SMTP works with port 25, but it can also work with 587.
Security Policy	SMTP email transfer does not provide encryption. If you want to make your connection more secure, it is a good choice to use a STARTTLS or SSL/TLS extension that employs a separate port for encrypted communication.
Authentication Policy	Authentication method for user logging in email server. Vigilant accepts <i>plain</i> and <i>login</i> .
User	User for accessing the email server.



Password	Password provided by your ISP.
Notify errors	When checked, the system will also send emails whenever an error is detected.
Alarm level	Select the minimum alarm level that will trigger the email notification.
Email addresses	Configure the set of email addresses to which the emails will be sent.
Time Zone	Sets the time zone the system will use for the e-mail notifications.
Custom message	Specifies a user-defined message which will be included in the body of the notification emails.



The *Notifications* service is limited to a maximum of **1 email** maximum per day.

The notification email will send only once, the first time that meets the condition. It will include information about all the alarms and errors since the last notification email was sent.



The system will not send more than one email per day, even if more critical alarm levels are reached. It will always wait a minimum of 24h before sending new emails.

On the other hand, the system will only send a single email for a certain alarm. Alarms that have already been noticed will not be indicated in new emails, that will only show new alarm appearances since the last notification. Until that alarm is acknowledged by an analyst in the [Alarm Toolbar](#) of the *Vigilant*, that specific alarm will not generate any new warning emails.

The automatic notification emails generated by this service will look like this:

#### Status report: machine M3

- Device model: VIGILANT
- Device serial: 8080289
- Date/Time: 09-07-2021 13:19:34 UTC

Level	Source	Value/Message	First occurrence
Error	M3:P3	Sensor bias voltage is too low (-0.02)	06-05-2021 14:42:06 UTC
Danger	M3:P3:PTP	0.000006	06-05-2021 14:44:28 UTC
Error	M3:P3	A value equal to or less than 0V (Voltage) cannot be converted to dBuV (Voltage)	06-05-2021 15:02:52 UTC

- Device model: specific model and reference of the system.
- Device serial: serial number of the device.
- Date/Time: UTC time when the snapshot was taken, and condition was met.



The Date/Time indicated in the notifications email are always in generic UTC/GMT time, because the system does not have information about the local time in the place where the user is receiving the notifications.

### 11.8.3. Rsync and FTP services

VIGILANT includes two file transfer services: *RSync* and *FTP*. These services are activated by default and can be used to create backups of the data stored in the system.

The *FTP* service provides a way to download and upload files into or from the unit. VIGILANT runs an *FTP* server, so an *FTP* client is required in order to use this service (ex: Filezilla, WinSCP). Be sure the client uses the **binary** file format to upload and download files.



*ASCII format is not compatible with VIGILANT. An import of this type will corrupt the system*

*RSync*, on the other hand, is a service that allows incremental backups of files and folders. Only new or modified files are copied, making the backup process very efficient. VIGILANT also runs a *RSync* server, so a *RSync* client is required to use this service.

See <https://en.wikipedia.org/wiki/Rsync> for more information.



*Similarly, to FTP make sure to use binary format in order to upload and download files using RSync. Otherwise, the files will get corrupted.*



*RClone application is recommended for Windows operating system when using RSync protocol to download files from the Vigilant unit. This application also allows incremental backups and downloading files using FTP protocol.*

The following table shows the usernames and passwords of the *RSync* and *FTP* service.

Field	Content
Rsync username	“rsync”
Rsync password	Login password of the <i>admin</i> user.
FTP user	“ftp”
FTP password	Login password of the <i>admin</i> user.

The following picture shows the folders of the unit that can be accessed using *RSync* or *FTP* services.

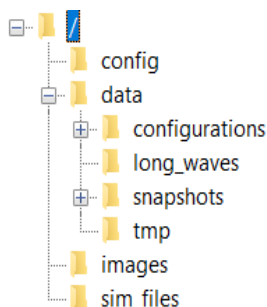

Folder	Description
Config	Contains the configuration files currently applied on the unit ( <i>conf.db</i> , <i>system.db</i> , <i>users.db</i> ). See... Import/Export for more details about these files).
Data	This folder is used to store the files <i>Alarms.db</i> and <i>Index.db</i> . The file <i>Alarms.db</i> contains the information about the historic alarms and notifications, and those currently active on the different <i>Machines</i> configured on the <i>Vigilant</i> unit. <i>Index.db</i> file on the other hand includes the historical values of the parameters, stored as trends in a SQL database for an easy and quick way to access them. This file is reconstructed from the <i>Capture</i> or <i>Snapshot</i> files when the option <i>Update Database</i> is selected on the menu <i>System/Records</i> . The folder also includes 4 sub-folders that organize other data stored in the unit.
Configurations	For internal use only.
Long_waves	Processing modes configured as <i>Long Waveform</i> are stored as independent files. These files include the data for each long waveform stored by the system, and no other data. This folder is divided into a maximum of 256 sub-folders, where these binary files with a single long waveform are actually stored.
Snapshots	This folder contains the files where the data for each <i>Snapshot</i> or <i>Capture</i> is stored on the <i>Vigilant</i> unit. These files are binary ones, and each of them contain all the data included in one capture (spectra, waveforms, parameters, alarm status, error status, etc.). See... for more information. The folder is divided into a maximum of 256 sub-folders, where these binary files are actually stored.
tmp	Folder used for temporary. This folder does not require to be copied when making a backup.
Images	Stores the file images imported into the unit.
Sim_files	Include the files imported as simulation files in the unit (see...).

When making a backup, it is recommended to copy, either by using the *RSync* or *FTP* services, at least the files included in the folders *Snapshots* and *Long Waveforms* (this last one only in case long waveforms processing modes are configured). These folders contain all the raw data that allows to visualize the data and reconstruct the database with the trends. It is also recommended to copy the *Config* folder with the current configuration files. In particular the file *conf.db* is very important. It does not contain any measurements but includes the definition of the machines and its components and is required to restore it in the unit when doing a restoration.



*The backups can be restored in any VIGILANT unit. It is not required to be installed on the unit from which the backup was performed.*

## 11.9. Storage

*Storage* settings define how the unit uses the flash memory. By default, VIGILANT employs an internal micro-SD card for storing data. Since firmware version 0.7.0, this internal memory is not essential, and the system can work without the SD card or even with a card that is damaged. In such a case, the device will not be able to permanently store any measurement data and will notify that event in the [Exception indicator](#). See [Micro-SD card maintenance](#) section for more details.

This form sets the way the unit will delete *Snapshots* when the number of records reaches its limit (10.000 per machine) or when the external flash memory gets full, so the unit is able to store new measurements. The system provides the following options:

- *Oldest* strategy is based on the *FIFO* records, so that the new records will occupy the place of the oldest ones.
- *Random* strategy. This alternative uses a random strategy to remove records that allocate room for new ones. This is useful for storing data in the long run. Its long-term effect is the lowering of the data density (less records) on the oldest periods while having more density on the newer ones. The reason for this is that older records participate on more record removals than newer ones.

### Storage

Device SD Card ▾

Erasing strategy Oldest ▾

---

#### SD Card Information

In use: Yes  
Filesystem: FAT32  
Size: 3792 MB

Field	Description
Device	Select the internal flash memory (microSD card) or none. In this latter case, trends and timelines will not be available and only live data will be displayable
Erasing strategy	Select <i>Oldest</i> or <i>Random</i> .
In use	Indicates if the system's SD card is being used or not (although being detected and available).
Filesystem	Indicates the file format detected in the SD card (usually FAT32 or EXT3).
Size	Total amount of space in the microSD card.
Format	This button is only available if the micro-SD is <i>NOT</i> in use and allows to format the card with the selected file format.



Changes in this menu will only apply after **rebooting** the system.

### 11.10. Records

This menu shows the usage of the device internal storage memory, and how it is shared between different machines and types of data. It also allows deleting data, entirely or partially.



If the storage device (micro-SD card) is not in use, i.e. it is disabled, this menu will remain inactive.

The *Vigilant* stores the data in its internal flash memory using different file formats or type of files.

A *Snapshot* or *Capture* is defined as a complete set of measurements of a machine, taken simultaneously at a given time. This set of data is stored in a single file in the micro-SD card. Each *Snapshot* includes, as minimum, all the parameters or scalar values defined on the configuration of the machine, and optionally (depending on the configuration of the *Storage Strategies*) also include the waveforms and spectra. *Long waveforms* are stored separately, but their files also reference of a *Snapshot* to which they are related to.

*Snapshots* are stored in the mSD card as “records”. The system currently allows a maximum of 10,000 records per machine, regardless of the actual space occupied by them on the card.

VIGILANT uses a *SQL* database for data storage and classification. This database stores simplified information, including trends of the different parameters, static measurements, speed, load, status of the machines, etc. The system updates this database when new measurements are stored. It also makes a periodic automatic backup of the database in the SD card, and just before shutting down the system. This database allows the system to quickly restore the trends from the RAM when restarting the unit.

This *Records* form allows the reconstruction of the *SQL* database by reading the *Snapshots* stored in the flash memory. This option is useful when it is suspected that the database may be corrupted, or when the user recovers data from a backup.

The form shows two different lists of records, one for the *Snapshots* (parameters, waveforms and spectra) and another one for the *Long-Waveforms*.

At the top of the form, a bar graph displays the percentages of SD card memory used, for each type of records (*Snapshots*, *Long-waveforms* and “others”), and it shows the free space available and the size of the SD card.

[Update database](#)

### Usage

- Snapshots: 60.6% (2293 MB)
- Long Waves: 15.1% (573 MB)
- Other: 0.4% (16 MB)
- Free: 23.8% (901 MB)
- Total: 3784 MB

#### Machine records

Machine	Records	First record	Last record	
M3	2/10000	29/09/2022 14:31:58	29/09/2022 14:32:58	<a href="#">Delete range</a>
<a href="#">M1</a>	847/10000	29/09/2022 14:43:40	05/10/2022 12:23:00	<a href="#">Delete range</a>
<a href="#">M2</a>	139/10000	29/09/2022 15:34:00	05/10/2022 11:43:00	<a href="#">Delete range</a>
				<a href="#">Delete all</a>

#### Long wave records

Processing Mode	Records	First record	Last record	
<a href="#">M1:P3_channel3:UT_longtimewaveform</a>	781	29/09/2022 14:43:40	05/10/2022 12:13:00	<a href="#">Delete range</a>
<a href="#">M2:P4_channel4:UT_longtimewaveform</a>	123	29/09/2022 15:34:00	05/10/2022 07:31:30	<a href="#">Delete range</a>
				<a href="#">Delete all</a>

The following table describes the data included on the *Machine* and *Long waveform* lists.

Field	Description
Machine	Shows the list of machines configured on the unit.
Machine Records	Shows the number of records ( <i>Snapshots</i> or <i>Captures</i> ) stored for each machine on the SD card.
Long wave records	Shows the number of long waveforms stored in the SD card for each processing mode.
First record	Date and time of the first <i>Capture</i> stored for the machine.
Last record	Date and time of the last <i>Capture</i> stored for the machine.
Delete range	Deletes the records ( <i>Snapshots/Captures</i> or <i>Long waveforms</i> ) within a time range.
Delete all	Deletes all the ( <i>Snapshots/Captures</i> or <i>Long waveforms</i> ) stored on the SD card for all the machines.
Update database	Rebuilds the database into RAM from the <i>Captures</i> stored in the flash memory.

Clicking on the *Update database* button at the top-right of the form, rebuilds the internal MySQL database that includes the trends of the scalar measurements (*Index.db*). This is done by reading all the *Snapshot* files available in the SD card. While executing this process the following screen will be displayed until it is finished.

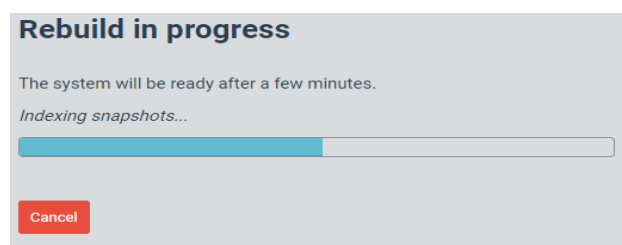

### 11.11. Simulation files

Dynamic inputs can be linked to simulation files. These files have a special format that allows the unit to “reproduce” a dynamic signal on the corresponding channel. This allows the users to work with the unit using signals previously recorded or generated externally, without sensors. Once linked to one channel, the files are continuously “reproduced” to replace acquisitions.

This form allows users to manage the simulation files, loading new ones or deleting those already present in the system.

Simulation files		
Name	Size	
BADslowbearing2.wav	1.2 MB	Delete
badbearing.wav	234.0 kB	Delete
bearing 2.wav	1.2 MB	Delete
well greased.wav	31.3 kB	Delete

Select file

Note: Allowable file limit: 4 MB

Field	Description
Name	Shows the name of the simulation file.
Size	Informs about the size of the simulation file.
Delete	Deletes the simulation file from the list. The system will ask for confirmation before the execution of the action.
Select file	Allows the user to select the simulation file that will be imported into the system. Files must be smaller than 4 Mb.

Please refer to the [Appendix A](#) to get more information about how to generate your simulation files.

### 11.12. Bearing files

VIGILANT includes a database containing more than 50 thousand bearing references from different manufacturers. Obviously, this database does not include all existing bearings, and users may be interested in expanding the database with more references.

For this purpose, this form allows uploading spreadsheet files with lists of bearings to be added to the database of the device. The format of the spreadsheets must be CSV (it is a standard format that can be generated with any text editor). The fields must be separated by commas and use the point as a decimal separator. The CSV file must have the following fields:

	A	B	C	D	E	F	G
1	manufacturer	reference	BPFI	BPFO	BSF	FTF	Z
2	TORRING	YTU2 7/16	5.934	4.066	2.584	0.407	10

Where BPFO, BPFI, BSF and FTF refer to the fault frequencies, expressed in order and Z refers to the number of rolling element (per row).

The header (first line) must correspond exactly to the one shown in the figure. The meaning of the fields will be described in detail later in this document.



*The first line of the files uploaded to the system must correspond exactly to the header shown in the example*

### 11.13. Licenses

Shows a list describing the modules or features available in the *Vigilant*. Please refer to [Appendix B](#) about [Optional software features](#) to complete this list of available modules.

## Licenses

Features	Description
Extended Processing Blocks	Extend the number of available processing blocks
Waveform-Spectrum	Enable Waveform and Spectrum widgets
Data Storage	Enable Data Storage, Timeline and Trends widget
Demodulation	Enable Wave demodulation
Long Waveform Analysis	Enable Long Waveform record and analysis tools
Spectrum Waterfall	Enable Spectrum Waterfall widget
Modbus	Obtain data from Modbus devices
OPC	Read and write data on OPC servers
Custom Email Server	Enable custom SMTP server for email notifications
Offline Firmware Upgrade	Enable firmware upgrading from file

Enter new code

Contact your *Vigilant* system provider to obtain other specific features that are not available by default. We will send you an alphanumeric code that can be pasted into the pop-up menu that appears when you click on the button on this form. Once the code is introduced, and the *unit* is rebooted, the corresponding license will be activated.

### 11.14. Upgrade firmware

This form shows the current firmware version of the *Vigilant* unit and allows upgrading it to the latest version available. See the chapter about [Upgrading the firmware](#) to learn more about this process.

### Upgrade firmware

This page allows you to upgrade the VIGILANT firmware.

**Version** 1.0.2

**Repository** Stable

Upgrade from server ▾
Check for updates

If the unit is *offline*, the firmware can be updated by selecting a file downloaded beforehand in your local PC. Select *Upgrade from file* option then click on the *Select file* button.

Upgrade from file ▾

Select file

Otherwise, you will need direct connection to the Internet to contact the distant server.

Upgrade



If the *Upgrade from server* option is selected, the button *Check for new updates* will verify if there is a new version of firmware available for the device. If that is the case, clicking on the *Upgrade* button will download and install all the files required for upgrading the firmware.

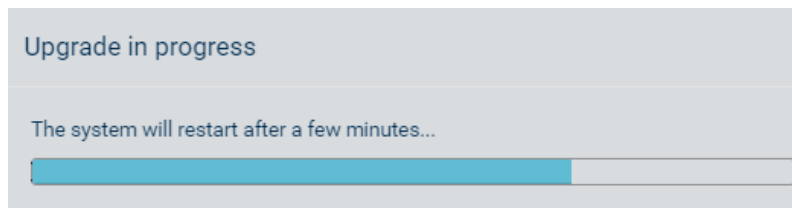

Below the current firmware version ID, the interface shows if it will look for new firmware in a *Stable* or in a *Testing* repository instead. The last options allow loading beta releases of the firmware. Only SDT personnel can change this setting.

The latest firmware can be downloaded at:

<http://ftp.sdt.be/pub/Products/VIGILANT/Vigilant/Firmware/>



*Do not disconnect the unit while upgrading the firmware.*

### 11.15. Event Log

This menu shows the events occurring sequentially in the system. This option helps to monitor the current activity of the unit (captures, storage, trigger events, errors, alive heartbeat, alarms being triggered, etc.).

The interface will present a list of events that will be updated in real time. The last event will appear at the top of the list and will show the date/time at which the event was produced.

Event Log	
14:07:46	ss:M1
14:07:42	timer-alive
14:07:41	ss:M1
14:07:36	ss:M1
14:07:32	timer-alive
14:07:31	ss:M1
14:07:30	ss:M2
14:07:30	lw_progress:M2:P4_channel4:UT_longtimewaveform:77.07
14:07:27	ss:M1
14:07:22	timer-alive
14:07:21	ss:M1
14:07:16	ss:M1
14:07:12	timer-alive
14:07:11	ss:M1
14:07:06	ss:M1
14:07:02	timer-alive

## 11.16. Export/Import

The *System maintenance* menu can be accessed through the icon  at top of the System menu:

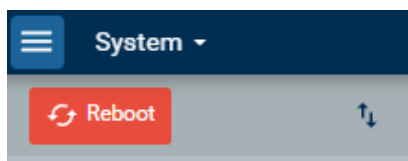

The *Export/Import* form provides the tools to make backups of the different configuration settings of the unit (*Main configuration*, *System settings* and *User settings*). It also allows users to import backups or to restore the configuration from previous settings or from factory settings.

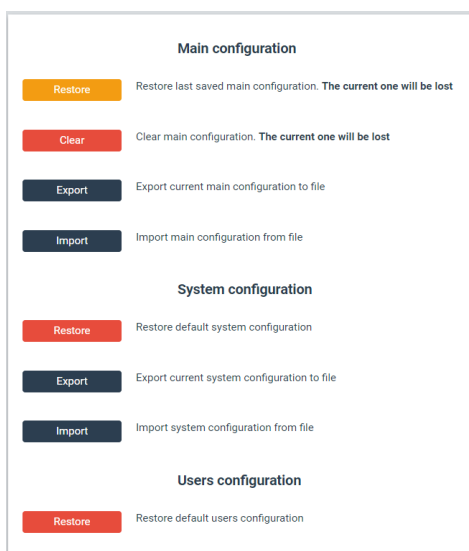

### 11.16.1. Main configuration

The *Main* or *Monitoring* configuration provides information related to the machines, points, processing modes, parameters, machine status, storage strategies, input channels, sensors, etc...

Field	Description
Restore	Restores the last applied monitoring configuration. Current settings will be lost.
Clear	Clears the <i>Monitoring</i> configuration, deleting all configured settings (machines, points, processing modes, sensors, etc.). The <i>Monitoring</i> configuration of the unit gets completely empty.
Export	Exports the <i>Monitoring</i> configuration into a <i>.db</i> file called <i>conf</i> plus the current date and time (i.e. <i>conf_2021_04_03_6.45.db</i> ). The file will include the complete information related to the monitoring settings configured on the unit: machines, points, processing modes, parameters, machine status, storage strategies, input channels, sensors, etc.
Import	Imports into the unit the <i>conf.db</i> file containing all the configuration settings for a machine or group of machines: points, processing modes, parameters, sensors, etc.

### 11.16.2. System configuration

The *System* configuration provides information related to the system settings of the unit: ethernet configuration, host name, active services, time settings, etc.

Field	Description
Restore	Restores to factory settings the <i>System</i> configuration. The IP address of the unit will be set at 192.168.0.150, or 10.8.2.150 in case the unit was supplied with the <i>Mobility</i> case.
Export	Exports the <i>System</i> configuration settings into a <i>.db</i> file called <i>System</i> plus the current data and time (i.e. <i>system_2021_04_03_6.45.db</i> ).
Import	Imports into the VIGILANT unit, a <i>System</i> configuration file selected by the user.

### 11.16.3. User's configuration

Field	Description
Restore defaults	Restores the default user's configuration: It deletes all users other than <i>admin</i> , restores the <i>admin</i> user's default password and deletes user preferences in the <i>Dashboard</i> .

## 12. Configuration

### 12.1. Introduction



This section describes the *Main* or *Monitoring Configuration* interface of the VIGILANT. This includes the configuration of its *Inputs*, *Outputs*, *Sensors*, *Machines*, *Points*, *Processing Modes*, *Storage Strategies*, etc. The section also describes its usage and defines all the available fields and concepts in the system for a correct monitoring configuration.

### 12.2. Toolbar

The *Monitoring Configuration* interface is identified by a vertical Toolbar on the left menu. This toolbar shows the general configuration options on its upper part, and the machine's configuration at the bottom part.

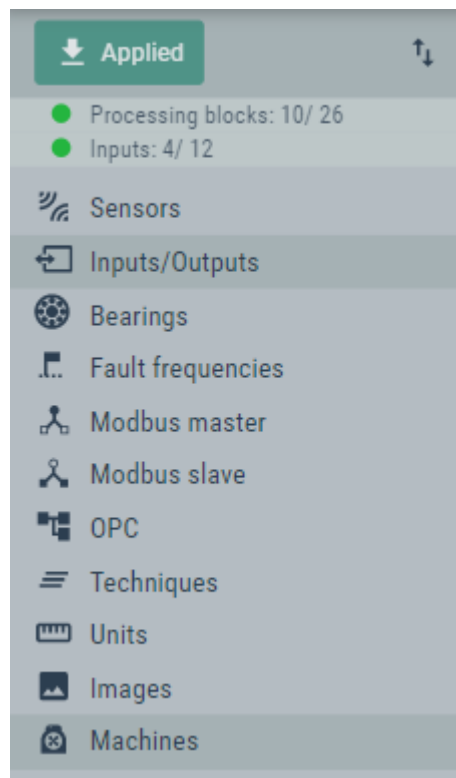
The user configuration is to be done, step-by-step, in descending order, from the inputs to the definition of the Machines



Option	Description
	This button applies the changes made into the configuration database to the <i>Vigilant</i> unit. It shows the text <i>Apply</i> when a change has been made on the configuration but has not been actually applied. Once applied, the button changes to <i>Applied</i> informing user that no change are applicable, so the configuration database matches the monitoring configuration the unit is actually using.
	This button provides access to the <a href="#">Export/Import</a> tools. These tools allow users to restore the last applied <i>Monitoring</i> or <i>Main</i> configuration settings, and to restore the <i>System</i> and <i>User Configuration</i> to factory/previous

		settings. They also allow exporting the <i>Monitoring/Main</i> , <i>System</i> and <i>Users</i> settings into backup files, or to import them from previously exported ones.
Processing blocks: X/26		This field indicates the number of <i>Processing Blocks</i> being used by the unit and its maximum capacity (26= full charge). See <a href="#">Processing Blocks</a> for more information.
Inputs X/12		Indicates the number of physical <i>Inputs</i> of the device that are being currently used, along with the number of physical inputs available.
Inputs/Outputs		Configures the physical inputs and outputs (connectors) of the <i>Vigilant</i> unit.
Sensors		Defines the characteristics of the sensor to be used
Bearings		Defines bearings so that they can be assigned to specify fault frequencies in the dynamic measurement <i>Points</i> .
Fault Frequencies		Defines the fault frequencies that will be available in the system to be assigned to the dynamic points.
Modbus master (TCP-IP)		Sets properties to configure the <i>Vigilant</i> as client in the network, asking other devices for their register's values
Modbus slave (TCP-IP)		Sets properties to configure the <i>Vigilant</i> as server in the network, allowing other devices to access different parameter values.
OPC		Sets properties to configure the <i>Vigilant</i> as OPC-UA client for connecting to OPC endpoints and be able to read or write nodes
Techniques		Defines the techniques that will be able to be assigned to the different points.
Units		Sets the properties and units available on the system.
Images		Defines the images available on the system to be assigned to a machine.
Machines		Configures the <i>Machines</i> to be monitored with the <i>VIGILANT</i> ( <i>similar to the tree structure in UAS3</i> ). The <i>Monitoring Configuration</i> toolbar shows the list of <i>Machines</i> defined on the unit and provides access to their particular configuration components (see <a href="#">Machines</a> ).

### 12.2.1. Processing Blocks

*Processing blocks* define the capacity to execute simultaneous signal processing with the data coming from the different inputs of the unit.

Each *Processing Mode* configured on the Main *Inputs* of the unit consumes one *Processing Block*. Similarly, *Inputs* (both Dynamic or Static) configured as Pulse Train also consume one *Processing Block*. The number of *Processing Blocks* on the unit is the sum of the number of *Processing Modes* defined for all the different machines configured on the system plus the number of *Inputs* configured as Pulse Train.

The maximum number of *Processing Blocks* is limited at 16. Users can add *Processing Modes* or define *Inputs* as Pulse Train until this limit of *Processing Blocks* available is reached.

### 12.2.2. Apply button

The *Apply* button located at the upper part of the toolbar checks the monitoring configuration and applies the changes. In case any problem on the configuration is found the interface shows a list of errors, as shown below. Each item of the list provides a link to the form containing the error.

Item	Level	Error
<a href="#">Strategy Strategy 1</a>	Error	Invalid cron line: Expected 5 or 6 fields, found 2: */10*

Cancel

In case no errors are found the system asks for confirmation to apply the configuration (see image below). Clicking on the *Apply configuration* button the system will apply the configuration into the unit, which will start monitoring with the new monitoring settings. The text on the button will change into “Applied”.

Are you sure you want to apply the configuration?

Cancel

Apply configuration



All changes made on the configuration interface will store on the configuration database. However, they will not be applied into the *Vigilant* until the configuration errors are checked, and the Apply configuration button is pressed.

### 12.3. Sensors

This section configures the sensors that will be able to be connected to the *VIGILANT* inputs. This menu option shows the list of preconfigured sensors that can be used by the unit.

Sensors							
Name	Model	Serial number	Type	Unit	Sensitivity (V/unit)	Delete	Copy
<a href="#">COMMONSense-60dB</a>	FU.SEN.RSV.001/2/3		Dynamic	V	1200	Delete	Copy
<a href="#">COMMONSense-48dB</a>	FU.SEN.RSV.001/2/3		Dynamic	V	301.2	Delete	Copy
<a href="#">COMMONSense-36dB</a>	FU.SEN.RSV.001/2/3		Dynamic	V	75.3	Delete	Copy
<a href="#">COMMONSense-24dB</a>	FU.SEN.RSV.001/2/3		Dynamic	V	19.2	Delete	Copy
<a href="#">COMMONSense-12dB</a>	FU.SEN.RSV.001/2/3		Dynamic	V	4.8	Delete	Copy
<a href="#">COMMONSense-0dB</a>	FU.SEN.RSV.001/2/3		Dynamic	V	1.2	Delete	Copy
<a href="#">ACCELEROMETER</a>	HS-100		Dynamic	G	0.1	Delete	Copy
<a href="#">TEMPERATURE</a>	HS-100T		Static	°C	0.01	Delete	Copy

By selecting one of the items of the list, the interface will show the configuration screen of the corresponding sensor.

User must refer to the specifications of the sensor to fill these fields.

For example, a standard accelerometer of type 100 mV/g is defined as follows:

Name*	<input type="text" value="Accelerometer"/>
Description	<input type="text" value="Enter value of description"/>
Manufacturer	<input type="text" value="Enter value of manufacturer"/>
Model	<input type="text" value="Enter value of model"/>
Serial number	<input type="text" value="Enter value of serial number"/>
<b>Signal</b>	
Input unit	<input type="text" value="Acceleration"/> <input type="text" value="G"/>
Sensor type	<input type="text" value="Dynamic"/>
Sensitivity*	<input type="text" value="0.1"/> <input type="text" value="V/(G)"/>
Offset*	<input type="text" value="0"/> <input type="text" value="V"/>
Frequency range	<input type="text" value="Enter value of frequency range"/>
<b>Limits</b>	
Check AC/bias	<input checked="" type="checkbox"/>
Maximum peak	<input type="text" value="50"/> <input type="text" value="G"/>
Min. bias voltage	<input type="text" value="9"/> <input type="text" value="V"/>
Max. bias voltage	<input type="text" value="12"/> <input type="text" value="V"/>

An SDT COMMONSENSE Ultrasound sensor (defined at gain = +60 dB in dynamic mode) should be defined as follows, based on the specifications given at

[http://ftp.sdt.be/pub/Products/COMMONSense/Datasheet/COMMONSense\\_0-10Voltage\\_Contact\\_Datasheet.pdf](http://ftp.sdt.be/pub/Products/COMMONSense/Datasheet/COMMONSense_0-10Voltage_Contact_Datasheet.pdf)

Fill the fields according to the specifications of COMMONSENSE 0-10 V:

- **Name:** *COMMONSense\_60dB*.
- Others non-mandatory fields (*description, manufacturer, model, serial number*) do not matter and you can fill them with whatever you think useful for your needs.
- Input unit : Voltage, in [V]
- **Sensor type:** Dynamic (factory settings at +60 dB)
- **Sensitivity:** 1200 V/V
- **Offset voltage\*:** 3 V
- The limits fields are recommended. They will generate system alarms in case of inappropriate amplification settings
  - **Minimum** -0.0017 V
  - **Maximum** 0.0017 V
- Terminate by clicking the **Accept** button.

**Sensor** COMMONSense contact 60dB
Cancel Accept

---

Name\*

Description

Manufacturer

Model

Serial number

**Signal**

Input unit

Sensor type

Sensitivity\*

Offset\*

Frequency range

**Limits**

Check AC/bias

Minimum

Maximum

Field	Description
Name	Identifies unequivocally the sensor. It can contain numbers, upper and lower characters. Special characters or blank spaces are not allowed.
Description	This field provides a description of the sensor.
Manufacturer	Defines the manufacturer of the sensor.
Model	Defines the model of the sensor.
Serial number	Indicates the serial number of the sensor.
Input Unit	Sets the magnitude/property measured by the sensor and defines its units. Both the units and magnitudes will be selected from a pull-down menu. The units and magnitudes available are defined on the <a href="#">Units</a> section.
Sensor Type	Defines if the sensor provides a static or a dynamic signal.
Output Type	Sets the type of output provided by the sensor. In most cases it will be voltage, but some sensors provide current outputs or are resistive sensors. VIGILANT only allow voltage output sensors.
Sensitivity	Sets the sensitivity of the sensor in volts per engineering units, as defined in the previous field.
Offset	Value in volts of the signal offset provided by the sensor.
Frequency range	Dynamic range of the sensor. Range of frequencies in which it is able to give valid readings.
Check AC/bias	This checkbox defines if both the DC and AC components of the signal must be validated by the system (applies only for dynamic sensor type).
Minimum	Defines the minimum allowable value for the signal provided by the sensor.
Maximum	Defines the maximum allowable value for the signal provided by the sensor.



Maximum Peak	Sets the maximum peak value allowed for the AC component of the signal provided by the sensor. Applies only for dynamic sensors, when <i>Check AC/bias</i> is checked.
Min. bias voltage	Sets the minimum value in volts allowed for the DC component of the signal provided by the sensor. Applies only for dynamic sensors, when <i>Check AC/bias</i> is enabled.
Max. bias voltage	Sets the maximum value in volts allowed for the DC component of the signal provided by the sensor. Applies only for dynamic sensors, when <i>Check AC/bias</i> is enabled.



For static sensors, VIGILANT will calculate the corresponding measurement using this formula:

$$\text{Measurement} = \frac{(\text{Channel reading} - \text{Offset})}{\text{Sensitivity}}$$

where *Offset* and *Sensitivity* are set on the corresponding properties.



For dynamic sensors, the *Offset* value is subtracted from the raw dynamic signal before converting it to the corresponding units using the *Sensitivity* defined.

## 12.4. Inputs

This section defines the configuration of the inputs. By clicking on this option, the interface shows the inputs list.

By clicking on one of the items of the list, the interface will show the configuration of the corresponding input. Once configured, the added item defines the correlation between the sensor and the physical input of the VIGILANT that must be used to connect the sensor.

Inputs							
Name	Mode	DC Coupling	Gain	Sensor	IEPE	Simulation file	Path
<a href="#">Input 1</a>	Dynamic	true	1	COMMONSense-60dB	No	BADslowbearing2.wav	<a href="#">M1:P1_channel1</a>
<a href="#">Input 2</a>	Dynamic	true	1	ACCELEROMETER	Yes	badbearing.wav	<a href="#">M1:P2_channel2</a>
<a href="#">Input 3</a>	Dynamic	true	1	COMMONSense-60dB	No	bearing 2.wav	<a href="#">M1:P3_channel3</a>
<a href="#">Input 4</a>	Dynamic	true	1	COMMONSense-60dB	No	well greased.wav	<a href="#">M2:P4_channel4</a>
<a href="#">Input 5</a>	Dynamic	true	1	COMMONSense-24dB	No	-	-
<a href="#">Input 6</a>	Dynamic	true	1	COMMONSense-12dB	No	-	-
<a href="#">Input 7</a>	Dynamic	true	1	-	Yes	-	-
<a href="#">Input 8</a>	Dynamic	true	1	COMMONSense-0dB	No	-	-
<a href="#">Input A1</a>	Pulse train	-	-	-	No	-	<a href="#">M1:RPM</a>
<a href="#">Input A2</a>	Voltage	-	1	TEMPERATURE	No	-	<a href="#">M1:TEMPERATURE</a>
<a href="#">Input A3</a>	Voltage	-	1	-	No	-	-
<a href="#">Input A4</a>	Voltage	-	1	-	No	-	-

Field	Description
Name	Shows the input channel to be configured.
Mode	Defines the type of input that will be used: <ul style="list-style-type: none"> <li><i>Dynamic</i>: used for voltage dynamic signals (vibration, ultrasound). Enables the input to sample the signal at high frequency sampling rates.</li> <li><i>Voltage</i>: used for voltage static signals. The input will sample the signal at low sampling rates.</li> </ul>

	<ul style="list-style-type: none"> <li>• <i>Pulse train</i>: sets the channel to read pulsed voltage signals. This type of input mode allows the system to measure the frequency of the pulses in Hz. The trigger level and hysteresis can be set up by the user.</li> <li>• <i>Digital</i>: sets the input to read digital voltage signals. These inputs return a value of 1 when the signal goes above the trigger value, returning a 0 otherwise. A hysteresis band is created around this trigger value. The user can set both values.</li> </ul>
DC Coupling	By marking this checkbox, the DC component of the signal will not be filtered out. It only applies to <i>Dynamic analog</i> input types.
Channel gain	Defines the gain or amplification ratio that will be applied to the signal connected to the input channel. This option modifies the input range, or maximum amplitude the input will be able to measure. For a gain of 1 maximum voltage for the channels is $\pm 24$ V. Applies to <i>Dynamic</i> and <i>Static</i> type inputs.
Sensor	Selects the sensor assigned to the input channel. Only shown for <i>Dynamic</i> and <i>Static Analog</i> type inputs.
IEPE	Activate IEPE current source to power the sensor.
Threshold	Selects the voltage value that will be used to trigger a <i>Pulse train</i> input mode.
Hysteresis	Sets a hysteresis around the threshold voltage that triggers the pulse detection. For example, a hysteresis value set at 0.1 V and threshold set at 1V will make the system detect the pulse when the signal goes above 1.1V, and will stop detecting it when the signal goes below 0.9V. Static inputs do not allow configuring this value.
Edge	Selects if the pulses of the signal will be detected during their raising or falling side.
Simulation	Selects a file containing a simulation signal that will replace the input signal for that channel. The simulation signal contained in the file will be replayed continuously.
Path	Indicates the actual <a href="#">Machines</a> and measurement points that are using this analog input to acquire monitoring data. Clicking on the link will lead to their configuration.

Clicking on one of the items it will lead to the configuration menu the corresponding input, where some additional parameters are available:

The screenshot shows a configuration window titled "Input 1". It contains the following fields and controls:

- Name\*: Input 1
- Input mode: Dynamic (dropdown)
- DC coupling:
- Gain: 4 (dropdown)
- Sensor: Sensor 1 (dropdown)
- Input range: 60 G pp (dropdown)
- IEPE:
- Simulation section:
  - Simulation file: None (dropdown)

At the bottom right, there are "Cancel" and "Accept" buttons.

## 12.5. Bearings

This section configures the list of bearings that will be able to be assigned to the dynamic *Points*. By selecting this menu option, the interface displays the list of rolling bearings currently defined on the system.

### Bearings

Name	FTF	BSF	BPFO	BPFI		
<a href="#">FAG-81132</a>	0.5	7.444	17	17	Delete	Copy
<a href="#">SKF-6310</a>	0.381	1.98	3.047	4.953	Delete	Copy
<a href="#">SKF-6310E</a>	0.377	1.914	3.018	4.982	Delete	Copy

New Import

From this list the rolling bearings can be deleted or copied by using the corresponding buttons (*Delete*, *Copy*) at the right of each item. When the *Copy* button is pressed, the interface will ask to enter the name of the new rolling bearing that the configuration of the one selected will be copied into.

Do you want to copy this element? Please enter a new name

Cancel OK

By pressing the *Delete* button the interface will ask to confirm if the bearing must be deleted.

Do you really want to delete this element?

Cancel OK

By clicking on one of the items of the list the interface will show the configuration of the corresponding rolling bearing. By clicking on the *New* button on the other hand this configuration page will be shown with all the fields blank.

### New bearing

Cancel Accept

Name\*

Description

Manufacturer

Reference

Number of harmonics

FTF

BSF

BPFO

BPFI

Enter geometry

Number of balls

Ball diameter  mm

Pitch diameter  mm

Contact angle  °

Update defect frequencies

Field	Description
Name	Identifies unequivocally the rolling bearing. It can contain numbers, upper and lower characters. Special characters or blank spaces are not allowed.
Description	Text describing the rolling bearing.
Manufacturer	Defines the bearing manufacturer.
Reference	Reference name or serial number given by the manufacturer of the bearing.
Number of harmonics	Sets the number of harmonics of the bearing fault frequencies that will be shown on the spectrum.
FTF	Sets the value of the fundamental train frequency of the bearing.
BSF	Sets the value of the ball spin frequency of the bearing.
BPFO	Sets the value of the ball pass frequency of the outer race of the bearing.
BPFI	Sets the value of the ball pass frequency of the inner race of the bearing.
Enter geometry	By enabling this checkbox, the system allows to introduce the geometry of the rolling bearing. Once introduced these geometry values will set the fault frequencies of the rolling bearing.
Number of balls	Defines the number of balls of the rolling bearing.
Ball diameter	Defines the diameter of the balls of the rolling bearing.
Pitch diameter	Sets the pitch diameter of the rolling bearing.
Contact angle	Sets the contact angle of the balls of rolling bearing along the raceways.

When pressing *Import* button, the system allows to select a rolling bearing from the database.

Please enter your search criteria

Available bearings in database: 141740

Manufacturer

Reference

Please select the bearings to import

Select	Manufacturer	Reference	FTF	BSF	BPFO	BPFI	Z
<input type="checkbox"/>	SKF	22210	0.43	3.427	7.303	9.697	17
<input type="checkbox"/>	SKF	22210C	0.43	3.481	7.749	10.251	18
<input type="checkbox"/>	SKF	22210CC	0.431	3.484	7.75	10.25	18
<input type="checkbox"/>	SKF	22210CC	0.43	3.48	7.75	10.25	18
<input type="checkbox"/>	SKF	22210CC <sup>2</sup>	0.431	3.484	8.18	10.82	19
<input type="checkbox"/>	SKF	22210E	0.424	3.164	7.628	10.372	18
<input type="checkbox"/>	SKF	22210ECC	0.429	3.417	8.583	11.417	20
<input type="checkbox"/>	SKF	22210	0.43	3.427	7.303	9.697	17
<input type="checkbox"/>	SKF	22210 E	0.431	3.485	8.181	10.819	19
<input type="checkbox"/>	SKF	22210 EK	0.431	3.485	8.181	10.819	19

Selecting one of the items of the list and pressing on the *Import* button will add the corresponding rolling bearing to the list.

Bearings						
Name	FTF	BSF	BPFO	BPFI		
<a href="#">FAG-81132</a>	0.5	7.444	17	17	Delete	Copy
<a href="#">SKF-6310</a>	0.381	1.98	3.047	4.953	Delete	Copy

New Import

## 12.6. Fault Frequencies

*Fault frequencies* are objects that define frequencies associated to a machine failure mode or to a characteristic frequency of the machine. These objects can be assigned to dynamic points and are visualized on the *Spectrum* widgets of the *Dashboard*.

When selecting this option, the interface will show the list of *Fault frequencies* defined on the unit. By clicking on the *New* button, the system adds a new *Fault frequency* to the list. The *Delete* buttons remove the correspondent *Fault frequency* from the list. The *Copy* button on the other hand creates a new *Fault frequency* and copies on it the configuration of the one selected.

Fault frequencies						
Name	Freq	N. Harmonics				
<a href="#">BPFI</a>	7.1x	10	Delete	Copy		
<a href="#">BPFO</a>	3.4x	10	Delete	Copy		
<a href="#">BSF</a>	2.3x	10	Delete	Copy		
<a href="#">FTF</a>	0.4x	10	Delete	Copy		
<a href="#">1xGMF</a>	23x	3	Delete	Copy		
<a href="#">5xRPM</a>	5x	3	Delete	Copy		

New

By clicking on *New* button to add a new periodic cursor.

**Fault frequency** **BPFO**

Name\*

Description

Use order

Frequency (order)  X

Number of harmonics

Cancel Accept

Option	Description
Name	Identifies unequivocally the <i>Fault frequency</i> . It can contain numbers, upper and lower characters. Special characters or blank spaces are not allowed.
Description	This field allows the user to include a description of the <i>Fault frequency</i> .
Use order	Select this option to define the fault frequency in orders (replace RPM)
Freq	Defines the frequency of the object. It can be defined in either Hz/CPM or in order units, depending on if the <i>Use Order</i> checkbox is selected or not. Order units are based on the RPM of the point. In the example above the fault frequency is set as 3.56 times the RPM defined for the point. If <i>Use Order</i> checkbox is not checked the user can select either CPM or HZ units to define the frequency.
Nb. of harmonics	Sets the number of harmonic lines to show on the spectrum.

## 12.7. Modbus master

The Modbus Master module allows connecting, with a TCP interface, to compatible instruments such as PLCs to read values and use them for advanced supervision

This menu defines the *external devices* that will act as Modbus servers, and also the internal *registers* in those devices that will be read by the *Vigilant*. Instruments acting as server or client must be in the same logical network.

The screenshot displays two configuration sections: 'Modbus servers' and 'Modbus registers'. Each section includes a table of existing configurations and a 'New' button for adding new entries.

**Modbus servers table:**

Name	Host	Port	Slave Id	Poll period	Actions
ZMDaq	192.168.0.107	502	1	15 s	Delete Copy

**Modbus registers table:**

Name	Server	Number	Type	Data type	Actions
Temperature 1	ZMDaq	1	Holding	int16	Delete Copy
Temperature 2	ZMDaq	2	Holding	int16	Delete Copy

The menu includes two separate forms that allow the configuration of external Modbus data sources. The first form concerns the connectivity parameters that define the external Modbus *servers to access*:

### Modbus server **ZMDaq**

Name\*

Description

Host\*

Port

Slave Id

Poll period  s

Option	Description
Name	Identifies the <i>Server</i> unequivocally. It can contain numbers, upper and lower characters. Special characters or blank spaces are not allowed.
Description	Text of description, for user notes only.
Host	IP address or web address of the device that will act as Modbus server.
Port	Number of TCP port that the server has reserved for Modbus communications. By default, the port number is 502.
Slave Id	Slave number of the server in the Modbus network.
Poll period	The reading of the <i>Modbus registers</i> on each server will be done on specific periods defined by this parameter.

The second form refers to the registers VIGILANT will access Modbus *registers*. *These details* are imposed by the server.

### New modbus register

Name\*

Description

Modbus server

Number\*

Type

Data type

Byte swap

Word swap

**Processing**

Factor\*

Offset\*

Unit

AC detector

Option	Description
Name	Identifies unequivocally the <i>Modbus register</i> within the system. It can contain numbers, upper and lower characters. Special characters or blank spaces are not allowed.
Description	Text with the description of the <i>Modbus register</i> .
Modbus server	Indicates which <i>Modbus server</i> the <i>Modbus register</i> is associated with.
Number	Defines the Modbus address or register number.
Type	Defines the type of modbus register: <ul style="list-style-type: none"> <li>• Coil (binary).</li> <li>• Discrete input (binary).</li> <li>• Input.</li> <li>• Holding.</li> </ul>
Data type	Sets the numeric data type that will read the system: <ul style="list-style-type: none"> <li>• Int16: integer number (16 bits). Takes 1 Modbus registers.</li> <li>• Int32: integer number (32 bits). Takes 2 Modbus registers.</li> <li>• Float: float number (32 bits). Takes 2 Modbus registers.</li> <li>• Unsigned int16: Unsigned integer number (16 bits). Takes 1 Modbus registers.</li> <li>• Unsigned int32: Unsigned integer number (32 bits). Takes 2 Modbus registers.</li> </ul>
Byte swap	Swaps the position of the 2 bytes in the <i>Modbus register</i> . Box unchecked indicates no swapping.
Word swap	Swaps the position of 2 words (16 bits each one) in a 32-bit data type. Box unchecked indicates no swapping.
Read value	Executes a single reading of the specific register. This allows to check the configuration of the register and its communication with the modbus server.
Factor	Factor to be applied to the data read by this register in order to convert the values into the desired format or units.
Offset	Convert the values into the desired format or units. The value of this <i>Offset</i> will be added to the data read by the register after multiplying it by the <i>Factor</i> defined on the corresponding field.
Unit	Selects the <i>Property</i> and <i>Unit</i> to be assigned to the data read by the <i>Modbus register</i> .
AC detector	Selects the AC detector (RMS, peak, p-p, none) that will be assigned to the data read by the <i>Modbus register</i> .



By default, Modbus registers are codified in *Big Endian* format. Using the swapping options, it is also possible to read numbers in *Little Endian* format.





The value that returns the modbus variable is defined by this formula:  
 $Modbus\_value = read\_value \times Factor + Offset$

## 12.8. Modbus slave

This option sets the *VIGILANT* as a Modbus-TCP server, allowing external systems to read any of the measurements and its status using this protocol. When selecting this menu option, the interface will show the list of *Machines*, *Points* and *Parameters* reflecting your configuration.

Machines				Autoassign registers... ▾
Tag	Type	Number of registers	Number	
▶ PUMP-23	block	8	1	Edit

Points			
Tag	Type	Number of registers	Number
▶ PUMP-23:M1V	block	4	101

Parameters				
Tag	Type	Number of registers	Number	
▶ PUMP-23:M1V:RMS	block	4	501	Edit
▶ PUMP-23:M1V:High_Frequency	block	4	505	Edit
▶ PUMP-23:M1V:True_P-P	block	4	509	Edit
▶ PUMP-23:M1V:Crest_Factor	block	4	513	Edit
▶ PUMP-23:M1V:Kurtosis	block	4	517	Edit
▶ PUMP-23:M1V:iPeak	block	4	521	Edit

Each component of the lists has different sub-components. Clicking on the icon ▶ at the left of each component the interface will show the sub-components. These sub-components are the variables that will be accessible by any external devices using Modbus-TCP protocol. All of the variables in the system are defined in the system as Modbus *Input* registers.

Machines				Autoassign registers... ▾
Tag	Type	Number of registers	Number	
▼ M1	block	8	33	Edit
speed	float	2	33	
load	float	2	35	
state	int16	1	37	
alarm	int16	1	38	
error	int16	1	39	
▶ M2	block	8	9	Edit

Option	Description
Tag	Identifies the <i>Machine</i> , <i>Point</i> or <i>Parameter</i> that the different variables belong to.
Type	Indicates the type of data for each variable (e.g. Int16, float, etc.). For <i>Machines</i> , <i>Points</i> and <i>Parameters</i> it indicates that they include a <i>Block</i> of different data or variables.
Number of registers	Number of Modbus <i>Input</i> registers (16bit) occupied by the component's block of data or by the different variables.
Number	Modbus-TCP address or register number assigned to the variable.

The *Edit* buttons of each component are used to manually set the initial Modbus-TCP address of the components. Then the system automatically defines the register number (Modbus-TCP *Input* register addresses) for each variable, considering the initial address of the component and the number of registers they occupy. This number of registers are shown on the list for each variable, along with its data type and the final Modbus-TCP address assigned.

The initial Modbus-TCP address numbers of the different components can also be assigned automatically by using the *Auto-assign registers* button. In the case of selecting *Only empty records* those components with no address number assigned will be set only. In case of *All* is selected the system will redefine automatically all the address numbers, assigning new ones even to those that were previously defined.

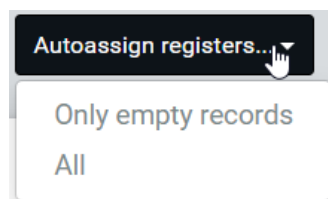

Once the Modbus addresses or register numbers are defined for the different variables, they will be accessible by other devices using these connection properties:

- **Host:** IP address in the local network
- **Port number:** 502
- **Slave ID:** 1
- **Register type:** *Input*

The following table describes the different types of variables that include each component.

Component	Variable	Description
Machines	Speed	This variable provides the speed measurement of the machine. This value can be read by the system using a static or dynamic input channel, by OPC or Modbus measurement or by a <i>Formula</i> . It can also be defined as a fixed value defined in the configuration.
	Load	This variable provides the load value of the machine. This value can be read by the system as an input channel, by OPC/Modbus measurement or by a <i>Formula</i> . It can also be defined as a fixed value defined in the configuration.
	State	Provides the status of the machine. It gives the number assigned to the state, as defined on the configuration of the <i>Machine</i> .
	Alarm	Provides the alarm condition of the <i>Machine</i> . It can take one of these numbers: 0 (no alarm), 1 (warning), 2 (alert), 3 (danger).

		The <i>Machine</i> takes the higher alarm condition of any of their measurements.
	<b>Error</b>	Provides a number different from 0 in case an error is found on any of the measurements of the <i>Machine</i> . See <a href="#">Error codes</a> for more information.
<b>Points</b>	<b>Vbias</b>	Provides the bias voltage value of the input channel associated with the corresponding <i>Measurement Point</i> .
	<b>Alarm</b>	Provides the alarm condition of the <i>Point</i> . It can take one of these numbers: 0 (no alarm), 1 (warning), 2 (alert), 3 (danger). The <i>Point</i> takes the higher alarm condition of any of their measurements.
	<b>Error</b>	Provides a number different from 0 in case an error is found on any of the measurements of the <i>Point</i> . See <a href="#">Error codes</a> for more information.
<b>Parameters</b>	<b>Value</b>	Provides the value of the corresponding <i>Parameter</i> .
	<b>Alarm</b>	Provides the alarm condition of the <i>Parameter</i> . It can take one of these numbers: 0 (no alarm), 1 (warning), 2 (alert), 3 (danger).
	<b>Error</b>	Provides a number different from 0 in case an error is found when measuring the <i>Parameter</i> . See <a href="#">Error codes</a> for more information.



All the variables of the VIGILANT are defined as Input registers, with the standard PLC address format (30000+ address).



*Some variables include long data format types (e.g. Float) that do not match with the standard Modbus Int16 Input registers, so they are defined using more than one Modbus Input register (e.g two registers for Float). Float values are defined in big-endian mode (most significant part in lower register).*

## 12.9. OPC

### 12.9.1. About OPC

The OPC (OLE for Process Control) is a communication standard used for industrial process control and supervision. It is based on Microsoft's OLE technology and offers a standard communication interface that allows individual software and hardware components to share data. OPC communication is done through a Client-Server architecture.

VIGILANT supports OPC-UA protocol, which is the evolution of OPC Classic standard. OPC-UA is a cross-platform industrial communication protocol. It is open source, service-oriented and provides rich information models with all the characteristics of classic OPC-DA specification for exchanging data. Unlike OPC Classic though it includes secure and platform independent communication mechanisms, which allows data exchange between different systems throughout any business layer.

To achieve this transversality OPC-UA incorporates high-security features natively. The first of these is the possibility of full encryption of messages. OPC UA allows encryption with AES-128 and AES-256 bits. It is also possible to implement SSL and HTTPS communications. The OPC-UA information model provides servers with a standard way to expose *Objects* to clients. *Objects* can be composed of other *Objects*, variables and methods, and they allow relationships with other *Objects*.

A set of *Objects*, with all their information, that an OPC UA server makes available to OPC-UA clients is called a *Namespace*. The OPC *Objects* are represented in the *Namespace* as a set of *Nodes* described by data structures and attributes that allow different services (e.g. their reading and/or writing according to the assigned permissions).

An OPC Endpoint on the other hand is a physical address available on a network that allows clients to access one or more services provided by a server. Server endpoint is specified by its URL string.

### 12.9.2. OPC UA client in Vigilant

*Vigilant* can be used as an OPC-UA client. This allows the connection to one or more OPC *Endpoints* (OPC-UA servers) to execute reading and/or writing services with one or more OPC *Nodes* (data structures served by the OPC-UA server).

Through the OPC configuration menu the user can create, clone, edit or delete OPC *Endpoints* and *Nodes*. The menu includes two separate lists that allow the configuration of external OPC *Endpoints* and *Nodes*.

**OPC endpoints**

Name	URI	Auth	Security		
<a href="#">OPCServer1</a>	opc.tcp://192.168.0.11:48020	Username Identity Token	None	Delete	Copy
<a href="#">OPCServer2</a>	opc.tcp://192.168.0.12:48020/admin	Anonymous	None	Delete	Copy

New Export Import

**OPC nodes**

Name	Endpoint	Node Id	Service		
<a href="#">OPCNode1</a>	OPCServer1	ns=4;s=Demo.Dynamic.Scalar.Float	Read	Delete	Copy
<a href="#">OPCNode2</a>	OPCServer1	ns=4;s=Demo.Static.Scalar.Float	Write	Delete	Copy
<a href="#">OPCNode3</a>	OPCServer2	ns=4;s=Demo.Dynamic.Scalar.Float	Read	Delete	Copy
<a href="#">OPCNode4</a>	OPCServer2	ns=4;s=Demo.Static.Scalar.Float	Write	Delete	Copy

New Export Import

The interface on the other hand allows importing from a CSV file, or exporting to a CSV file, both OPC *Endpoints* and *Nodes* by using the *Export* and *Import* buttons.

### 12.9.3. OPC endpoints

The OPC configuration menu shows at the top of the interface the list of external OPC *Endpoints*. Clicking on one element of the list, or clicking on “*New*” button, the interface will show up a screen with the configuration of the OPC *Endpoint*.

Name*	<input type="text" value="OPCServer2"/>
Description	<input type="text" value="Enter value of description field"/>
Protocol	<input type="text" value="TCP"/>
Host*	<input type="text" value="192.168.0.12"/>
Port	<input type="text" value="48020"/>
URL Path	<input type="text" value="admin"/>
Authentication	<input type="text" value="Anonymous"/>
Security Policy	<input type="text" value="None"/>
Poll period	<input type="text" value="5"/> S
Write period	<input type="text" value="5"/> S

Option	Description
Name	Identifies the <i>Endpoint</i> unequivocally. It can contain numbers, upper and lower characters. Special characters or blank spaces are not allowed.
Description	Text of description, for user notes only.
Protocol	Only TCP is supported.
Host	IP or web address of the device that will act as OPC endpoint.
Port	TCP port that the server has reserved for OPC communications. By default, VIGILANT is set at 4840.
URL Path	Additional URL address for the OPC-UA <i>Endpoint</i> (optional).
Authentication	Type of authentication used for access control. Allowed types are: - <i>Anonymous</i> . - <i>Username Identity Token</i> . In this case the user must define the <i>User</i> and <i>Password</i> fields.
Security Policy	Only the None option is allowed.
Poll period	Period for updating the values of the <i>Nodes</i> that belong to the <i>Endpoint</i> and are configured to execute <i>Read</i> services ( <i>Node</i> reading period).
Write period	Period for updating the values of the <i>Nodes</i> that belong to the <i>Endpoint</i> and are configured to execute <i>Write</i> services ( <i>Node</i> writing period).

#### 12.9.4. OPC nodes

In OPC-UA, every entity or data structure in the Namespace is a *Node*, with has a unique identifier (*NodeId*) defined with 3 elements:

- *NameSpaceIndex*: The index value that identifies the *Namespace* of the *Endpoint* to which the *Node* belongs.
- *IdentifierType*: Sets the type of identifier. This can be *Numeric*, *Opaque*, *String* or *GUID*.
- *Identifier*: Sets the identifier of the node. It has to be unique within the *Namespace* defined by the *NameSpaceIndex* field.

The following picture shows examples of OPC nodes.

NodeID	
NamespaceIndex	2
IdentifierType	numeric
Identifier	5001

NodeID	
NamespaceIndex	2
IdentifierType	opaque
Identifier	M/RbKBsRVkePCePcx24oRA==

NodeID	
NamespaceIndex	2
IdentifierType	string
Identifier	MyTemperature

NodeID	
NamespaceIndex	2
IdentifierType	GUID
Identifier	09087e75-8e5e-499b-954f-f2a9603db28a

Examples for different types of NodeIDs

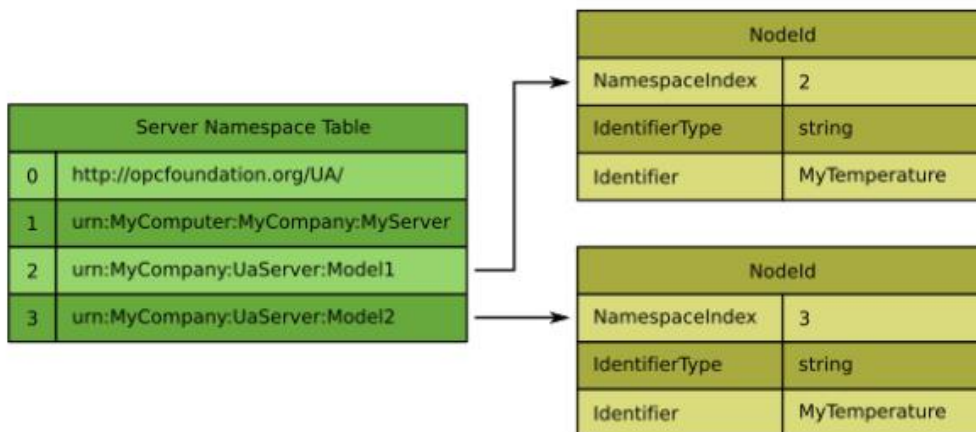

Nodes with the same Identifier in different namespaces

An example of a new node in *Vigilant* is defined by the following form:

Name\*

Description

Endpoint

Node ID\*

**NodeID examples (OPC UA NodeID Concepts)**

```
<ns=2;s=MyTemperature>
<i=2045>
<ns=1;g=09087e75-8e5e-499b-954f-f2a9603db28a>
<ns=1;b=M/RbKBsRVkePCePcx24oRA==>
```

namespace index 2, string identifier  
namespace index 0, numeric identifier  
namespace index 1, GUID identifier  
namespace index 1, Opaque/ByteString identifier

Option	Description
Name	Identifies the <i>Node</i> unequivocally within the unit. It can contain numbers, upper and lower characters. Special characters or blank spaces are not allowed.
Description	Optional description of the <i>Node</i> content.

Endpoint	OPC <i>Endpoint</i> associated with the <i>Node</i> . It must be selected from the pull-down menu with the list of <i>Endpoints</i> previously defined.
Node ID	Identifier of the OPC <i>Node</i> .

The *Node ID* identifier must be defined using an XML notation with the following format:

```
` ns = <namespaceIndex>; <identifiertype> = <identifier> `
```

The following codes must be used for the *IdentifierType* depending on its type:

- *Numeric*: "i"
- *Opaque*: "b"
- *String*: "s"
- *GUID*: "g"

The following image shows several examples of *Node ID* notation.

#### *NodeID examples (OPC UA NodeID Concepts)*

```
<ns=2;s=MyTemperature>
```

*namespace index 2, string identifier*

```
<i=2045>
```

*namespace index 0, numeric identifier*

```
<ns=1;g=09087e75-8e5e-499b-954f-f2a9603db28a>
```

*namespace index 1, GUID identifier*

```
<ns=1;b=M/RbKBsRVkePCePcx24oRA==>
```

*namespace index 1, Opaque/ByteString identifier*

The following image shows the additional fields to be configured in case the *Node* is defined to read data from the *Endpoint*.

### Processing

Service	<input style="width: 100%;" type="text" value="Read"/>	
Factor*	<input style="width: 100%;" type="text" value="1"/>	
Offset*	<input style="width: 100%;" type="text" value="0"/>	
Unit	<input style="width: 80%;" type="text" value="Temperature"/>	<input style="width: 20%;" type="text" value="°C"/>
AC detector	<input style="width: 100%;" type="text" value="None"/>	

Option	Description
<b>Service</b>	Select <i>Read</i> from the pull-down menu to use the read service that provides the OPC-UA protocol.
<b>Factor</b>	Factor to be applied to the data read by the <i>Node</i> . This factor value will be multiplied by the value read by the <i>Node</i> and is generally used to convert the number to a particular format or unit.
<b>Offset</b>	Offset value that will be applied to the data read by the <i>Node</i> in order to convert the values into the desired format or unit. The value of this <i>Offset</i> will be subtracted from the data read by the <i>Node</i> .
<b>Unit</b>	Selects the <i>Property</i> and <i>Unit</i> to be assigned to the data read by the <i>Node</i> .

<b>AC detector</b>	Selects the AC detector (RMS, peak, p-p, none) that will be assigned to the data read by the <i>Node</i> .
--------------------	--

OPC *Nodes* defined to use the read service can be assigned to *Static* points of the machine. On that way those values read by the *Node* using the OPC-UA protocol can be stored on the unit. The *Static* point must be configured as an OPC signal *Type* and the corresponding *Node* must be selected on the *OPC Node* pull-down field of the *Static* point configuration.

### Signal

Type

OPC Node

The following image shows the additional fields (besides the generic ones) to be configured in case the *Node* is configured as a *Write* service.

If the Write service is chosen for the OPC node, each Monitoring Period will write to that node the current value of a data source corresponding to system variables. In this case, the user must additionally configure the following fields in the form:

### Processing

Service

Data type

Source

Option	Description
Service	Select Write from the pull-down menu to use the write service that provides the OPC-UA protocol. This service allows the writing of data into the Node being configured.
Data type	Selects the type of data that is allowed to be written on the Node. The values of the Source will be converted into that data type before writing it into the Node.
Source	Selects the data source whose values will be written into the Node. The system allows selecting any of the measurements available on the system as the data source. The pull-down menu will show the list of all those available measurements.

The Read and Write buttons allow the system to test the communications with the Endpoints and Nodes being configured.

Read value

Write value

## 12.10. Techniques

This option defines the *Techniques* that will be available on the system. This allows the user to classify the points as part of a predictive *Technique*. This only has an informative function, so far.

By selecting this menu option, the interface will show the list of *Techniques* configured, which allows to edit, delete or create new ones.



Techniques	
Name	Desc
<a href="#">Vibration</a>	Vibration
<a href="#">Ultrasound</a>	Ultrasound
<a href="#">Electrical</a>	Electrical

New

Option	Description
Name	Text that identifies unequivocally the <i>Property</i> within the system. It can contain numbers, upper and lower characters. Special characters or blank spaces are not allowed.
Description	This field allows the user to include a description of the <i>Technique</i> .

### 12.11. Units

This option defines the Properties and Units that will be available on the system and that will be able to be linked to the Sensors. VIGILANT comes with a list of factory predefined Properties.

Properties	
Name	Label
<a href="#">Acceleration</a>	a
<a href="#">Angle</a>	Angle
<a href="#">Current</a>	I
<a href="#">Digital</a>	Digital
<a href="#">Displacement</a>	L
<a href="#">Flow</a>	Q
<a href="#">Force</a>	F
<a href="#">Freq.</a>	f
<a href="#">Mass</a>	M
<a href="#">None</a>	None
<a href="#">Power</a>	P
<a href="#">Pressure</a>	p
<a href="#">Ratio</a>	Ratio
<a href="#">Resistance</a>	R
<a href="#">Speed</a>	$\omega$
<a href="#">Temperature</a>	T
<a href="#">Time</a>	Time
<a href="#">Velocity</a>	v
<a href="#">Voltage</a>	V
<a href="#">Volume</a>	V

New

The predefined *Properties* are read-only and cannot be deleted or edited. Those created by the user however can be removed from the system by pressing on the *Delete* button.

New *Properties* can be created by clicking on the *New* button. The following screen shows the fields that defines a *Property*.

Option	Description
Name	Identifies the <i>Property</i> unequivocally. It can contain numbers, upper and lower characters. Special characters or blank spaces are not allowed.
Label	Text that will be used on the <i>Dashboard</i> to identify the <i>Property</i> .
Integrates to	Selects into what <i>Property</i> it will be converted when integration is selected.

The system also includes a set of predefined *Units*. These predefined *Units* are read-only and cannot be deleted or edited. Those created by the user however can be removed from the system by pressing on the *Delete* button.

The following image shows part of the list of predefined *Units*.

Label	Property	Factor	Offset	dB Reference
	None	1	0	-
Hz	Freq.	1	0	-
CPM	Freq.	0.017	0	-
V	Voltage	1	0	-
kV	Voltage	1000	0	-
mV	Voltage	0.001	0	-
μV	Voltage	1e-06	0	-
m	Displacement	1	0	-
ft	Displacement	0.305	0	-
cm	Displacement	0.01	0	-
mm	Displacement	0.001	0	-
mil	Displacement	2.54e-05	0	-
μm	Displacement	1e-06	0	-
m/s	Velocity	1	0	-
cm/s	Velocity	0.01	0	-
mm/s	Velocity	0.001	0	-
G	Acceleration	9.81	0	-
m/s²	Acceleration	1	0	-
cm/s²	Acceleration	0.01	0	-
mm/s²	Acceleration	0.001	0	-
°C	Temperature	1	0	-
°F	Temperature	0.556	-17.78	-
K	Temperature	1	-273.1	-
A	Current	1	0	-
mA	Current	0.001	0	-
Bar	Pressure	1	0	-
PSI	Pressure	0.069	0	-

New *Units* can also be defined, which can be associated to the predefined or to new *Properties* created by the user. The following screen shows the fields that define the *Units*.

Option	Description
Label	Text that identifies unequivocally the Unit within the system. It can contain numbers, upper and lower characters. Special characters or blank spaces are not allowed.
Property	Sets the Property associated to the Unit.
dB unit	Sets if the Unit will be used with a linear or a logarithmic scale (dBs).
Factor	Sets the factor that converts the default Unit of the Property into the one being configured. The default Unit is shown at the right of this field, and on its definition is set with a conversion factor of 1.
Offset	Defines the offset applied to the measurement to convert its units into the Unit being configured. This value will be subtracted from the measurement after applying the Unit factor.
dB Reference	Sets the reference value (in default Units) for the dB calculation. This field is only available in case decibel units are selected.
dB Factor	Sets the scaling factor to be applied to decibel units (10 or 20). This field is only available in case decibel units are selected.



*Units can be configured to behave linearly or logarithmically with respect to the reference unit. For some Units, a proportional scaling transformation is used, via the equation of a line, using a slope and an offset. Decibel scales use a logarithmic transformation, based on the relationship between the new unit and the reference unit. A multiplicative factor is applied to the logarithm which is defined on the dB factor.*

## 12.12. Images

This option defines the Images that will be available on the system. Images can be assigned to the machines and presented on the Dashboard using the Mimic type Widget.

The interface shows the list of Images defined currently on the system when selecting this menu option.

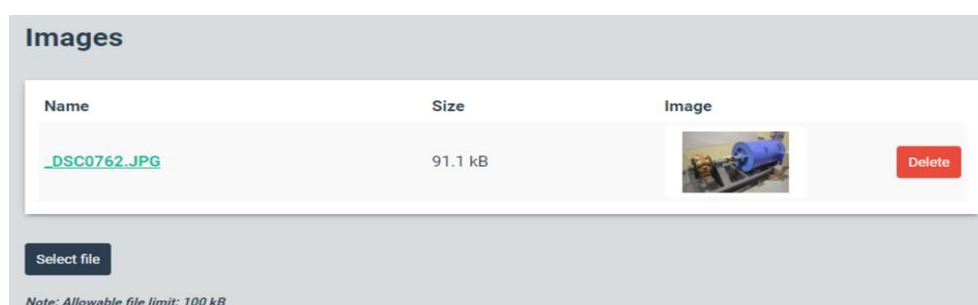

The Delete button removes the Image from the list. On the other hand, clicking on the image name presents the image in large format on a modal window.

The Select File button will show a modal window that allows to select the image file to be added to the list (maximum size allowed is 2 Mb). Once the file is selected, the interface will show the Upload button. By clicking on it, the image file will be uploaded to the unit.

### 12.13. Machines

*Machines* are the main objects for setting the monitoring configuration in the *Vigilant* unit. They are composed of different basic objects: *Alarms*, *Components*, *Points*, *Spectral Bands*, *States* and *Storage strategies*. The configuration of all these basic elements within the machine defines the monitoring behavior of the unit.

*Points*, in turn, contain the objects *Processing Modes*. These objects define the different types of measurements that will be performed on each measurement point. They define the sampling frequency, number of samples to acquire (duration), signal processing and filtering, etc. For each point up to 4 *Processing Modes* can be defined. Each *Processing Mode* can include several objects called *Parameters*.

These objects are scalar indicators calculated by the unit (Overall values, RMS, peak to peak values, DC values, crest factor, kurtosis, etc.) using the different signals defined on the *Processing Modes* of the point.

The following image shows an example of the different types of components and its hierarchy for a machine called Pump.

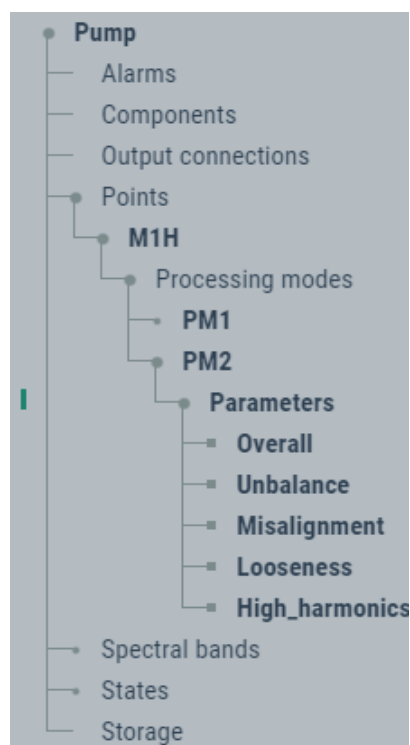

Those items of the tree in bold represent the names of the objects that the machine is composed of, while those not in bold represent the type of elements in the hierarchy.

By clicking on the items related to the machine's type of components, the interface will show on the right the list of objects defined of that type. By clicking on any of them the interface will display their configuration page. The following table describes the different objects that define the configuration of the machines.

Objects	Description
Alarms	Simple configuration of the alarm levels applied to all the parameters extracted for monitoring the machine, showing all of them in a single list.
Components	Displays the different components of the Machine (e.g. motor and pump). Points can be assigned to a machine Component.
Points	Points define the measuring locations on the Machine. They are associated with a sensor and an input channel on the unit.  There are 3 types of Points: <ul style="list-style-type: none"> <li>• Dynamic: Those associated with a dynamic input.</li> <li>• Static: Those associated with a static input, a measurement taken by digital communications (Modbus-TCP or OPC) or a calculated measurement (formula).</li> <li>• Tachometer: Those associated with a Pulse train input.</li> </ul>
Spectral Bands	Defines the frequency bands that will be available on the system in order to configure the RMS parameters calculated from the spectrum measurements
States	Defines the different States of the Machine. These States allow the system to set, based on them, different Storage strategies and apply different alarm limits for the measurements.
Storage	These objects define the storage strategies that the unit will apply for the different measurements of the Machine. They are configured by selecting an event and setting a condition. For each Machine as many Storage strategies as required can be created. See Storage Strategies for more information.
Processing Modes	Processing modes set the signal processing that will be applied to the inputs of the VIGILANT (filtering, enveloping, rectification, etc.) and defines the properties of the spectrum and waveform that will be measured on each Point (sampling frequency, window type, resolution, averages, number of samples, number of bins, etc.). For each Point, the system can measure several Processing modes, with a maximum of 26 cumulated for all the Points.
Parameters	These are scalar indicators that are calculated from the time signal configured at the <i>Processing Mode</i> and using different mathematical algorithms (overall values, spectral bands, crest factor, kurtosis, etc.).

The Machines defined on the unit will be displayed on the configuration tree, below the “Machines” label. Alternatively, clicking on Machines, on the configuration tree, the interface will display the list of machines.

Tag	Name	Model	Enabled	Period	Speed	Image
PUMP-23	Demo machine		true	6 s	x 1	 <span>⬆️ Delete</span> <span>Copy</span>

From this list, the machines can be deleted or copied by using the buttons on the right of each item. Clicking on one of the machines of the list, or on the tree, the interface will show its configuration. Click on the “new” button to create a new machine from scratch.

## Monitoring

Enabled

Period  s

Delay at start-up  s

Buffer size 32896 samples

## Speed

Tachometer  ▾

Rated speed   ▾

## Load

Load point  ▾

Rated load   ▾  ▾

## Elements

Field	Description
Tag	Text that identifies unequivocally the <i>Machine</i> . Only ASCII alphanumeric characters are allowed, including ".", "-", and "_". Any other special characters or blank spaces are not allowed. The first character must be alphanumeric. Maximum length is 25 characters.
Enabled	Enables or disables the <i>Machine</i> within the unit. Disabling it will cause the unit to completely ignore the <i>Machine</i> . The <i>Dashboard</i> will not show it in the interface and the system will not measure it. The configuration tree will indicate this by displaying the text <i>Disable</i> by the <i>Machine</i> name.
Name	Text used on the <i>Dashboard</i> to identify the <i>Machine</i> .
Description	Text describing the <i>Machine</i> .
Manufacturer	Defines the <i>Machine</i> manufacturer.
Model	Defines the model of the <i>Machine</i> .
Serial Number	Defines the serial number that identifies the <i>Machine</i> .
Support class	Defines from a pull-down menu the ISO 10816-3 Support class that will be assigned to the machine.
Rated power	Defines the rated power of the <i>Machine</i> in kW
Image	Assigns an image to the <i>Machine</i> . This image will be shown in the <i>Dashboard</i> using the <i>Mimic Widget</i> .

Enabled (monitoring)	Enables/disables the monitoring of the <i>Machine</i> . When disabled the <i>system</i> will not measure or store any data. However, existing data will be available in the <i>Dashboard</i> . The configuration tree will indicate this by displaying the text <i>Monitoring off</i> by the <i>Machine</i> name.
Period	Sets the refreshing rate (monitoring period) for the measurements of the <i>Machine</i> in seconds. This is independent on the sampling time required for each <i>Processing mode</i> due to the pre-buffering capabilities of the VIGILANT.
Delay at start-up	Defines a delay time the system will wait for before starting the monitoring of the <i>Machine</i> after a new configuration has been applied. This delay allows accelerometers to stabilize by waiting for its settling time to elapse.
Buffer size	Indicates the maximum number of samples required to monitor this machine in all of the points and processing modes defined in its configuration.
Tachometer	Sets the point that will be used to measure the speed of the <i>Machine</i> . It may either be a <i>Pulse tachometer</i> point or a <i>Static</i> point ( <i>Static Inputs, Modbus, OPC or Formula</i> ) with speed output format ( <i>Speed</i> units).
Rated speed	Nominal speed of the <i>Machine</i> . It can be defined in CPM or Hz.
Load point	Sets the point that will be used to measure the load of the <i>Machine</i> .
Rated load	Nominal load of the <i>Machine</i> . It can be defined in any of the magnitudes and units set up in the system.
Alarms	Provides a quick access to the <i>Alarm</i> menu, which allows a quick and easy configuration of alarm levels for all the parameters.
Components	Shows all the <i>Components</i> of the <i>Machine</i> . Clicking on one of them will access its configuration page.
Points	Shows all the <i>Points</i> defined on the machine. Clicking on one of them will access its configuration page.
States	Shows all the <i>States</i> defined on the machine. Clicking on one of them will access its configuration page.
Storage	Shows all the <i>Storage Strategies</i> defined on the machine. Clicking on one of them will access its configuration page.



*The speed of the machine can also be calculated using the parameter “Frequency extraction” calculated from a dynamic point. In order to use this parameter as the speed reference of the machine the system needs to get it from an actual point. This may be done by creating a Formula type Static Point and linking it to the frequency extraction parameter.*

The following chapters describe the configuration of the *Components, Points, States, Strategies, Processing Modes and Parameter* objects that compose the *Machine*. Their configuration defines the monitoring behavior of the unit.

## 12.14. Alarms

This section displays a table where users can configure the alarm levels for all the measurements defined on the machine (parameters and static points), independently for each *Machine* state. The table allows quick and easy access to the alarm limits.

Autoassign alarms Import Export

State Measuring

Advanced

<input checked="" type="checkbox"/>	Point	Parameter ▲	Unit	Type	LD	LA	LW	UW	UA	UD	Hyst	Rep
<input type="checkbox"/>	P1	90x_Peak_Phase	V RMS	None								
<input type="checkbox"/>	P1	90x_Peak_Phase_phase	rad	None								
<input type="checkbox"/>	Tachometer	freq	Hz	None								
<input type="checkbox"/>	Tachometer	freq_span	Hz	None								
<input type="checkbox"/>	P1	Mean	V	Window3	-5	-3	-1	1	3	5	0.01	0
<input type="checkbox"/>	P2	Mean	V	None								
<input type="checkbox"/>	P4	Mean	V	Window3	-5	-3	-1	1	3	5	0.01	0
<input type="checkbox"/>	P5	Mean	V	Window3	-5	-3	-1	1	3	5	0.01	0
<input type="checkbox"/>	P6	Mean	V	Window3	-5	-3	-1	1	3	5	0.01	0
<input type="checkbox"/>	P7	Mean	V	Window3	-5	-3	-1	1	3	5	0.01	0
<input type="checkbox"/>	P1	Peak2Peak	V PP	Upper3				2	4	6	0.01	0

Field	Description
State	Alarm levels may differ depending on the machine <i>State</i> . This control selects one of the available states for the machine and shows its corresponding alarm values in the table.
Advanced	Show the fields <i>Hysteresis</i> and <i>Repetitions</i> and use them to define with more accuracy the behavior of the alarms.
Autoassign alarms	Enter the dialog that enables automatically assigning the alarm values to the selected parameters using statistical calculations
[Select]	The checkboxes enable selecting a group of parameters to execute some action on them, like for example assigning statistical alarms.
Point	<i>Point</i> to which the parameter is related.
Parameter	Indicates the <i>Parameter</i> or measurement to set the alarm limits.
Unit	Shows the units of the <i>Parameter</i> or measurement.
Type	Selects the type of alarm to be set for the <i>Parameter</i> or measurement. These are different options: <ul style="list-style-type: none"> <li>• <i>None</i>. The values on the table will be ignored. No alarms will be assigned to the measurement.</li> <li>• <i>Upper2</i>. Sets 2 upper limits for the measurement (UA, UD).</li> <li>• <i>Upper3</i>. Sets 3 measurement upper limits (UW, UA, UD).</li> <li>• <i>Lower2</i>. Sets 2 lower limits for the measurement (LA, LD).</li> <li>• <i>Lower3</i>. Sets 3 measurement lower limits (LW, LA, LD).</li> <li>• <i>Window2</i>. Sets 2 upper and lower limits (LA, LD, UA UD).</li> <li>• <i>Window3</i>. Sets 3 upper and lower limits (LW, LA, LD, UW, UA UD).</li> </ul>
LD	<i>Lower Danger</i> . Sets the value of the lower danger limit.
LA	<i>Lower Alert</i> . Sets the value of the lower alert limit.
LW	<i>Lower Warning</i> . Sets the value of the lower warning limit.
UW	<i>Upper Warning</i> . Sets the value of the upper warning limit.
UA	<i>Upper Alert</i> . Sets the value of the upper alert limit.
UD	<i>Upper Danger</i> . Sets the value of the upper danger limit.



Hyst	Sets the hysteresis value used for calculating the change in the alarm level. See <i>next section for more information.</i>
Rep	Sets the number of repetitions needed to change the alarm level. See <i>next section for more information.</i>



*Use the Accept button before navigating to another part of the application in order to save any change made. Otherwise, the changes made will be lost.*



*The table presents different values according to the Machine state selected in the State pull-down menu at the top of the page.*

The table allows users to copy and paste cells of the table and sort their columns in order to facilitate the setup of values to users. Copying can be done by selecting the different cells, right-clicking with the mouse and selecting the Copy option, or by pressing the *CTRL+C* keys. Pasting the cells can be done by right clicking the mouse on the corresponding cells and selecting the *Paste* option, or by pressing the *CTRL-V* keys.

#### 12.14.1. Hysteresis and Repetitions

Clicking on the Advanced checkbox on the top of the page, the table will show the additional values that can be configured to set up more precisely the alarm behavior of any parameter:

Field	Description
Hysteresis	Sets the amount of hysteresis around the alarm limit. The value entered is an absolute value, and is added to the alarm levels (e.g. Warning, Alert, Danger) for the alarm to be activated, and subtracted from them for the alarm level to be deactivated. As an example, if Alert level of a Parameter is set at 4.5, and hysteresis is set at 0.5, the measurement value should be higher than 5 for the point entering into Alert status and go below 4 for the Alert status to be deactivated. Hysteresis helps when the parameter value is close to one of the alarm levels, so that the alarm status does not change too often.
Repetitions	Sets the number of measurements required to be out of alarm limits consecutively for that alarm to actually be activated. Similarly, if an alarm has been activated it also defines the number of consecutive measurements required to be within the alarm limits for that particular alarm to be deactivated. Here there are some examples: <ul style="list-style-type: none"> <li>• 0 repetitions (upper type): the alarm will be triggered as soon as the measurement goes above the alarm level and will be deactivated when it goes below the alarm level.</li> <li>• 1 repetition (upper type): the alarm will be triggered when 2 consecutive measurements are above the alarm level, and then it will be deactivated when 2 consecutive measurements are below the alarm level.</li> <li>• 2 repetitions (lower type): the alarm will be triggered when 3 consecutive measurements are below the alarm level, and then it will be deactivated when 3 consecutive measurements are above the alarm level.</li> </ul>

### 12.14.2. Statistical alarms

Statistical alarms allow the automatic generation of alarm values for a given set of parameters. This is achieved through a statistical analysis of the history of records that the system has collected in the past for these parameters.

Please select statistical alarms configuration

States

Use data from all states

Date range

Start date

End date

Minimum number of samples

Discarding factor  %

**Alarms**

Type

Levels

Show formula

Use limits

Statistical formula  $k_1\bar{x} + k_2\sigma + k_3$

Alarm	$k_1$	$k_2$	$k_3$	Min limit	Max limit
Danger	<input type="text" value="1.5"/>	<input type="text" value="7"/>	<input type="text" value="0"/>	<input type="text" value="0"/>	<input type="text" value="0"/>
Alert	<input type="text" value="1.5"/>	<input type="text" value="5"/>	<input type="text" value="0"/>	<input type="text" value="0"/>	<input type="text" value="0"/>
Warning	<input type="text" value="1.5"/>	<input type="text" value="3"/>	<input type="text" value="0"/>	<input type="text" value="0"/>	<input type="text" value="0"/>

Field	Description
States	Select to which Machine States the alarms will be calculated and applied.
Use data from all states	Calculate separately the alarm levels for each state or use all the data of the selected states together to compute global alarm levels that will be applied to all of them.
Date range	Use the historic data for all the periods that the device has records of those parameters or restrict the calculations to the data of a specific period.
Minimum number of samples	Sets a minimum number of records that will be necessary to obtain valid statistical alarm values. In case the algorithm detects that after the necessary discards this minimum number is not reached, no alarm values will be generated.
Discarding factor	Before averaging the historical records for statistical calculation, the system discards the outliers, which are the values that deviate the most from the median of the records considered. This operation eliminates possible noise data, bad readings or punctual failures, in order not to take them into account in the calculations. The discard factor can range from 0 to 50%.
Type	Select the alarm type to be generated: <ul style="list-style-type: none"> <li>• Upper</li> <li>• Lower</li> <li>• Window</li> </ul>
Levels	Select if 2 (Alert, Danger) or 3 (Warning, Alert, Danger) alarm levels will be generated.
Show formula	Enable configuring the statistical values that will be used to compute the alarms.

A formula such as the following is used for the statistical calculation of the alarms:

$$k_1 \cdot \underline{x} + k_2 \cdot \sigma + k_3$$

Where:

- $\underline{x}$  is the mean value of the parameter records, after discarding.
- $\sigma$  is the associated standard deviation.

Parameters  $k_1$ ,  $k_2$  and  $k_3$  set the alarm values from the above statistical values. If limits are used, the algorithm will discard the alarm values outside the indicated limits.

### 12.14.3. Import and export alarms

The Import/Export buttons available at the top right of the form allow the use of CSV files in order to configure the alarm levels of the Machine. These files can be edited with external applications and loaded into the VIGILANT to set the new alarm values. The Export button will create a CSV file with the alarm values of the selected parameters (those with the Select button enabled). Once the file has been created it can be read and edited from any spreadsheet software (Excel), or even from any simple text editor (Notepad). The following image shows an example of such a CSV file, opened with a spreadsheet software.

	A	B	C	D	E	F	G	H	I	J	K	L	M	N	O	P
1	id	State id	State name	Param id	Point tag	Param tag	Type	Levels	LD	LA	LW	UW	UA	UD	Hysteresis	Repetitions
2	3	2	Measuring	1	P1	RMS	0	3	0	0	0	2	3	5	0.01	0
3	7	2	Measuring	39	P3	RMS	0	3	0	0	0	2	3	5	0.01	0
4	10	2	Measuring	45	P4	RMS	0	3	0	0	0	2	3	5	0.01	0
5	13	2	Measuring	51	P5	RMS	0	3	0	0	0	2	3	5	0.01	0
6	16	2	Measuring	57	P6	RMS	0	3	0	0	0	2	3	5	0.01	0
7	19	2	Measuring	63	P7	RMS	0	3	0	0	0	2	3	5	0.01	0

The first line describes the content of each column. The rest of the lines contain the information that defines the configuration of the different alarms.

The fields "id", "Param id" and "State name" (in red on the image above) can be left empty when importing a CSV file from the application.



*In case no parameter has been selected the Export button will not be activated. It is required to select at least one parameter to be able to create a CSV file.*



*The CSV file format supported uses "," as field separator and "." as a decimal separator. If this convention is not respected the import of the alarm values may fail.*

The *Import* button allows selecting the CSV file which will be read to configure the alarms for the different parameters. When pressed a modal window allows selecting the corresponding CSV file, the system will ask to confirm the file selected.

### 12.15. Components

*Components* refer to the different parts that the machine is composed of. *Points* can be assigned to one of these *Components*. They have mostly an informative function.

By selecting this menu option, the interface will show the list of *Components* defined currently on the machine.

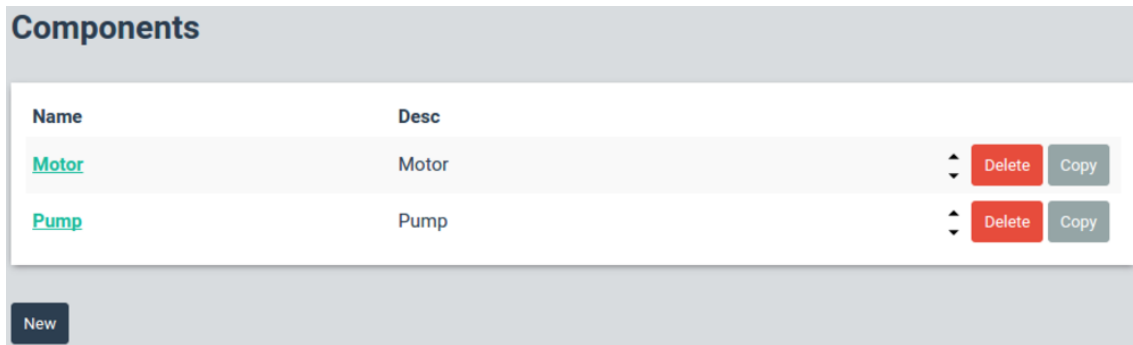

Clicking on one of the items of the list the interface will display the configuration page.

Component **Motor**

Name\*

Description

Cancel Accept

Field	Description
Name	Text that identifies unequivocally the machine. Only ASCII alphanumeric characters are allowed, including ".", "-", and "_". Any other special characters or blank spaces are not allowed. First character must be alphanumeric. Maximum length is 25 characters.
Description	Allows the user to include a description of the <i>Component</i> .

## 12.16. Points

*Points* are the objects where all the measurements, the *Vigilant* unit performs for the machine will be associated to. They are linked to an input source of data that bring information about the asset that is being monitored.

Points are classified in three different types, depending on the nature of their data and how it will be shown in the Dashboard:

- *Dynamic points*: *Points* associated with a dynamic data processing or measurement (spectra, waveforms, spectral bands, etc.). These points can only be associated with dynamic input channels.
- *Static points*: *Points* associated with scalar measurements that do not require dynamic data processing. They can be associated with a static input channel (analog or digital measurement), a Modbus or OPC measurement or the result of an expression defined by the user (*Formula* type measurements).
- *Pulse tachometer points*: *Points* used to calculate the frequency of a pulse train signal. They are typically used to measure the speed of a machine. They can also be used for phase calculations. These points can only be associated with pulse train input channels.



Besides pulse Tachometer points the machine speed can also be associated with Static measurements (scalar, Modbus, OPC, Formula), as long as they are defined on frequency units.

When selecting this menu option, the interface will display the list of *Points* defined currently on the *Machine*.

Tag	Name	Mode	Type	Source		Delete	Copy
M1V		Dynamic	Input	Input1	↕	Delete	Copy
M2H		Dynamic	Input	Input2	↕	Delete	Copy
B1H		Dynamic	Input	Input3	↕	Delete	Copy
B2V		Dynamic	Input	Input4	↕	Delete	Copy
B2A		Dynamic	Input	Input5	↕	Delete	Copy
R1H		Dynamic	Input	Input6	↕	Delete	Copy
R2V		Dynamic	Input	Input7	↕	Delete	Copy
RPM		Static	Input	Input8	↕	Delete	Copy

New... Import

From this list the *Points* can be deleted or copied by using the corresponding buttons at the right of each item. When the *Copy* button is pressed the interface will ask for the tag of the new *Point* the configuration of the *Point* selected will be copied to.

The *Import* button allows on the other hand to copy a *Point* from a different *Machine*, creating a new one of the same type with the configuration of the *Point* selected. When clicking on the *Import* button the interface will display a pull-down menu to select the type of *Point* to be imported.

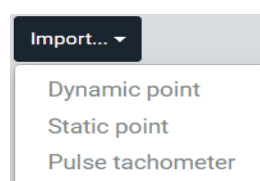

The interface will display a modal window where it can be selected the *Machine* and *Point* to be copied, and where it can be defined the tag of the new *Point* that will be created using the configuration of the selected *Point*.

Please select the point to import

Machine\* HP-Turbine

Point\* MAD-CY602

New tag\* MAD-CY605

Cancel Accept

The *New* button creates a new *Point* from scratch. When pressing this button, the interface will ask for the type of *Point* to create (*Dynamic*, *Static*, *Pulse tachometer*).

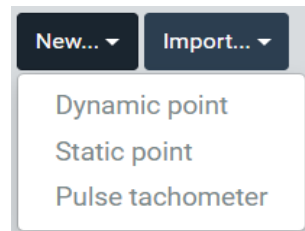

After selecting a type, the interface will display the configuration page of the new *Point*. This *Point* configuration page can also be displayed to be edited when clicking on any of the existing *Points* of the list.

The following chapters describe the configuration options for each type of *Points*. (*Dynamic*, *Static*, *Pulse tachometer*).

### 12.16.1. Dynamic points

Tag\*

Enabled

Name

Description

Technique

Component

Angle position\*  °

Spin direction\*

**Fault frequencies**

Custom

Bearings

**Mimic Label**

Hide labels

**Signal**

Input

Speed factor

Unit

**Elements**

Processing modes

Field	Description
Tag	Text that identifies unequivocally the <i>Point</i> within the <i>Machine</i> . Only ASCII alphanumeric characters are allowed, including ".", "-", and "_". Any other special characters or blank spaces are not allowed. First character must be alphanumeric. Maximum length is 25 characters.

Enabled	Disabling a <i>Point</i> causes the <i>Point</i> to be ignored completely by the system. The unit will not measure it and the <i>Dashboard</i> will not display it on any of its widgets.
Name	Text used on the <i>Dashboard</i> to identify the <i>Point</i> .
Description	Allows the user to include a description of the <i>Point</i> .
Technique	Sets the technique associated with the <i>Point</i> .
Component	Selects the <i>Machine</i> component to be assigned to the <i>Point</i> .
Angle position	For a dynamic <i>Point</i> this field sets the angle at which the sensor is positioned. An angle of 0° corresponds to a top vertical position. Angle direction can be selected clockwise (R) or counterclockwise (L). Angle references are typically set by looking from the driver side of the machine to the driven part. The system does not allow defining two points associated to the same component with identical or parallel angle positions.
Spin direction	Rotation direction of the shaft the <i>Point</i> is connected to.
Fault frequencies	Selects the different fault frequencies assigned to the <i>Point</i> , both those that were custom defined by the user in the <i>Fault frequencies</i> section, and also those related to the <i>Bearings</i> . The fault frequencies applied to the point will then be visible in the <i>Spectrum</i> widget, in the <i>Dashboard</i> , so that they can be easily identified.
Hide label (Mimic label)	Sets the location that the Point will take on the picture associated with the Machine and that will be shown on the Mimic widget of the Dashboard. Clicking on the picture places the label on that spot. The rest of the Point locations will be also shown on the picture, with a different format, to help select the location of the Point being configured. Activating the checkbox will hide the point on the Mimic widget.
Input	Selects the input channel the <i>Point</i> will get the data from.
Speed factor	Factor that will be used to calculate the speed associated with the <i>Point</i> and its measurements. It is calculated by multiplying the <i>Machine</i> speed by the value in this field.
Unit	Shows the units associated with the <i>Point</i> . The units are defined by the sensor configured for the corresponding input channel.
Processing modes	Shows all the <i>Processing modes</i> defined for the dynamic <i>Point</i> . By clicking on any of them the interface will display its configuration page. Clicking on the “...” button the interface will display the list of <i>Processing modes</i> . See <i>Processing Modes</i> for more information about their configuration.

### 12.16.2. Static points

Depending on its data source, *Static points* are classified by the following types:

- *Input*: these types of *Static points* get the data from a physical input of the unit. The corresponding input channel must have been configured as *Voltage* or *Digital* on its *Input Mode*.
- *Modbus*: these *Static points* get the data digitally, from an external [Modbus-TCP](#) server.
- *OPC*: these *Static points* get the data digitally, from an external [OPC](#) server.
- *Formula*: these *Static points* get its data from an expression or formula defined by the user, which can include any measurement read by the *system*, internal variables (e.g. timers, speed/load variation) and different arithmetic and logical operators.

Tag\*

Enabled

Hidden

Name

Description

Technique

Component

**Mimic Label**

Hide labels

**Signal**

Type

Input

Custom unit

Unit

**Limits**

Minimum

Maximum

Field	Description
Tag	Text that identifies unequivocally the <i>Static point</i> within the <i>Machine</i> . Only ASCII alphanumeric characters are allowed, including ".", "-", and "_". Any other special characters or blank spaces are not allowed. First character must be alphanumeric. Maximum length is 25 characters.
Enabled	Disabling causes the <i>Static point</i> to be omitted on the calculations and ignored by the <i>Dashboard</i> . In that case, the values referred to the point will not be calculated and cannot be referred to in expressions.
Hidden	Hidden causes the <i>Static point</i> to be ignored on the <i>Dashboard</i> , so that it will not be displayed on any of its widgets. Unlike with Disabling, the value will still be calculated and updated each monitoring cycle, so that it can be used for internal calculations (Machine States, Formula points, etc.)
Name	Text used on the <i>Dashboard</i> to identify the <i>Point</i> .
Description	Allows the user to include a description of the <i>Point</i> .
Technique	Sets the technique associated with the <i>Point</i> .
Component	Selects the <i>Machine</i> component to be assigned to the <i>Point</i> .
Hide labels (Mimic label)	Sets the location that the <i>Static Point</i> will take on the picture associated with the <i>Machine</i> and that will be shown on the <i>Mimic</i> widget of the <i>Dashboard</i> . Clicking on the picture places the label on that spot. The rest of the <i>Points</i> locations will be also shown on the picture, with a different format, to help select the location of the <i>Static Point</i> being configured. Activating the checkbox will hide the point on the <i>Mimic</i> widget.



Type	Set the type <i>Static point</i> depending on the source the <i>Point</i> gets its data from ( <i>Input, Modbus, OPC, Formula</i> )
Input	Selects the input channel the <i>Static Point</i> will get the data from. This field appears on the interface only when an <i>Input</i> type of <i>Static point</i> is selected on the <i>Type</i> field.
Register	Select the <u>Modbus register</u> the <i>Static Point</i> will get the data from. This field appears on the interface only when a <i>Modbus</i> type of <i>Static point</i> is selected on the <i>Type</i> field. Its pull-down menu will show the modbus registers defined on the unit.
OPC Node	Select the <u>OPC node</u> the <i>Static Point</i> will get the data from. This field appears on the interface only when an <i>OPC</i> type of <i>Static point</i> is selected on the <i>Type</i> field. Its pull-down menu will show the OPC registers defined on the unit.
Formula	Define the expression or formula whose output sets the measurement of the <i>Static Point</i> . This field appears on the interface only when an <i>Formula</i> type of <i>Static point</i> is selected on the <i>Type</i> field. Pressing on the <i>Edit</i> button a modal window will appear with the Expression Editor (see its description on the following page).
Unit	Shows the units associated with the <i>Point</i> . The units are defined by the sensor configured for the corresponding input channel.
Minimum	Defines the minimum value of the validation range of the measurement. Values outside the validation range are considered bad measurements. They do not trigger alarms and produce an error on the system.
Maximum	Defines the maximum value of the validation range of the measurement. Values outside the validation range are considered bad measurements. They do not trigger alarms and produce an error on the system.
Type (alarms)	Defines the type of alarms that will be associated with the measurement. They can either be <i>Upper, Lower</i> or <i>Window</i> . <ul style="list-style-type: none"> <li>• <i>Upper</i>: alarm levels are above normal values.</li> <li>• <i>Lower</i>: alarm levels are below normal values.</li> <li>• <i>Window</i>: alarm levels are within a window. If values go outside the window the measurement will go into alarm.</li> </ul>
Levels	Defines the number of alarm levels the <i>system</i> will consider for the corresponding <i>Point</i> . Selecting 3 the system will define 3 alarm levels: <i>Warning, Alert</i> and <i>Danger</i> . Selecting 2 the system will define only <i>Alert</i> and <i>Danger</i> levels.
State	Shows the machine <i>States</i> . The <i>system</i> can define different alarm levels for each of the machine <i>States</i> .
Enable	This checkbox enables or disables the alarms for the corresponding machine <i>State</i> .
Warning	Sets the value for the <i>Warning</i> alarm level for the corresponding machine <i>State</i> . It only shows up when the number of levels is set to 3.
Alert	Sets the value for the <i>Alert</i> alarm level for the corresponding machine <i>State</i> .
Danger	Sets the value for the <i>Danger</i> alarm level for the corresponding machine <i>State</i> .

Hysteresis	Sets the amount of hysteresis around the alarm limit. The value entered is an absolute value, and is added to the alarm levels (e.g. <i>Warning</i> , <i>Alert</i> , <i>Danger</i> ) for the alarm to be activated, and subtracted from them for the alarm level to be deactivated. As an example, if <i>Alert</i> level of a <i>Point</i> is set at 4.5, and hysteresis is set at 0.5, the measurement value should be higher than 5 for the point entering into <i>Alert</i> status and go below 4 for the <i>Alert</i> status to be deactivated. Hysteresis helps when the parameter value is close to one of the alarm levels, so that the alarm status does not change too often.
Repetitions	Sets the number of measurements required to be out of alarm limits consecutively for that alarm to actually be activated. Similarly, if an alarm has been activated it also defines the number of consecutive measurements necessary to be within the alarm limits for that particular alarm to be deactivated. Here there are some examples: <ul style="list-style-type: none"> <li>• 0 repetitions (upper type): the alarm will be triggered as soon as the measurement goes above the alarm level and will be deactivated when it goes below the alarm level.</li> <li>• 1 repetition (upper type): the alarm will be triggered when 2 consecutive measurements are above the alarm level, and then it will be deactivated when 2 consecutive measurements are below the alarm level.</li> <li>• 2 repetitions (lower type): the alarm will be triggered when 3 consecutive measurements are below the alarm level, and then it will be deactivated when 3 consecutive measurements are above the alarm level.</li> </ul>

The following picture shows an example of the [Expression Editor](#) that appears in a modal window when editing the formula of a *Formula* type *Static point*. These *Static points* get its data from the expression defined by this editor. The Expression Editor allows users to define the formula whose output will set the measurement of the *Static point*. The expression can combine any system parameter or values with several mathematical functions.

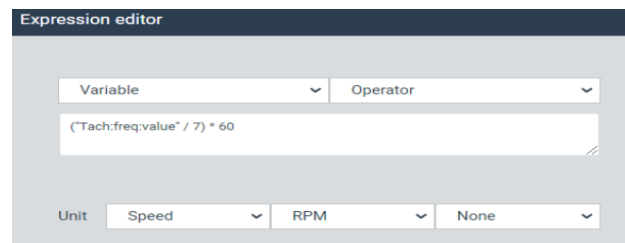

Field	Description
Variable	Pull-down menu including the list of all the variables that can be inserted on the expression. This includes: <ul style="list-style-type: none"> <li>• Measurements are performed on the unit.</li> <li>• Alarm status of each of the measurements.</li> <li>• Error status of each of the measurements.</li> <li>• Bias value in volts for each channel.</li> <li>• Internal variables (timers, speed/ change, error status, etc.).</li> </ul> See the <a href="#">Expression Editor</a> for the complete list of variables and their description. When selecting any of the variables from the pull-down menu the corresponding variable is copied on the expression field. This is used as a help for editing the expression.

Operator	This pull-down menu shows the list of all the variables that can be inserted on the expression. This includes both logical and arithmetic operators: “or”, “and”, “not”, “==”, “!=”, “>=”, “-”, “+”, “*”, etc. See the <a href="#">Expression Editor</a> for the complete list of variables and their description. When selecting any of the operators from the pull-down menu the corresponding variable is copied on the expression field. This is used as a help for editing the expression.
Expression	This field allows to write the expression
Unit	Selects the magnitude, unit and detector that will be associated to the output value of the expression, and so that to the measurement of the <i>Static point</i> .



Any system unit can be selected for the calculated value, even though their units are not consistent. Users must be able to determine the consistency of the output of the expressions and the units selected.



The values of the variables used in the Formula points are the ones calculated in the previous monitoring cycle.

### 12.16.3. Pulse tachometer points

Pulse tachometer **Rotation**

Tag\*

Enabled

Name

Description

Technique

Component

Angle position\*  °

Spin direction\*

**Mimic Label**

Hide labels

**Signal**

Input

Unit

**Limits**

Minimum  Hz

Maximum  Hz

**Elements**

Alarms

Field	Description
Tag	Text that unequivocally identifies the <i>Point</i> within the <i>Machine</i> . Only ASCII alphanumeric characters are allowed, including “.”, “-”, and “_”. Any other special characters or blank spaces are not allowed. First character must be alphanumeric. Maximum length is 25 characters.

Enabled	Disabling causes the <i>Point</i> to be ignored on the <i>Dashboard</i> , so that it will not be displayed on any of its widgets.
Name	Text used on the <i>Dashboard</i> to identify the <i>Point</i> .
Description	Allows the user to include a description of the <i>Point</i> .
Technique	Sets the technique associated with the <i>Point</i> .
Component	Selects the <i>Machine</i> component to be assigned to the <i>Point</i> .
Hide (Mimic label)	Sets the location that the <i>Point</i> will take on the picture associated with the <i>Machine</i> and that will be shown on the <i>Mimic</i> widget of the <i>Dashboard</i> . Clicking on the picture places the label on that spot. The rest of the <i>Point</i> locations will be also shown on the picture, with a different format, to help select the location of the <i>Point</i> being configured. Activating the checkbox will hide the point on the <i>Mimic</i> widget.
Input	Selects the input channel the <i>Pulse tachometer Point</i> will get the data from. Not available on A3 & A4
Unit	Shows the units associated with the <i>Point</i> . The default units for a <i>Pulse tachometer Points</i> are Hz.
Minimum	Defines the minimum value of the validation range of the measurement. Values outside the validation range are considered bad measurements. They do not trigger alarms and produce an error on the system.
Maximum	Defines the maximum value of the validation range of the measurement. Values outside the validation range are considered bad measurements. They do not trigger alarms and produce an error on the system.
Type (alarms)	Defines the type of alarms that will be associated with the measurement. They can either be <i>Upper</i> , <i>Lower</i> or <i>Window</i> . <ul style="list-style-type: none"> <li>• <i>Upper</i>: alarm levels are above normal values.</li> <li>• <i>Lower</i>: alarm levels are below normal values.</li> <li>• <i>Window</i>: alarm levels are within a window. If values go outside the window the measurement will go into alarm.</li> </ul>
Levels	Defines the number of alarm levels the <i>system</i> will consider for the corresponding <i>Point</i> . Selecting 3 the system will define 3 alarm levels: <i>Warning</i> , <i>Alert</i> and <i>Danger</i> . Selecting 2 the system will define only <i>Alert</i> and <i>Danger</i> levels.
State	Shows the machine <i>States</i> . The <i>system</i> can define different alarm levels for each of the machine <i>States</i> .
Enable	This checkbox enables or disables the alarms for the corresponding machine <i>State</i> .
Warning	Sets the value for the <i>Warning</i> alarm level for the corresponding machine <i>State</i> . It only shows up when the number of levels is set to 3.
Alert	Sets the value for the <i>Alert</i> alarm level for the corresponding machine <i>State</i> .
Danger	Sets the value for the <i>Danger</i> alarm level for the corresponding machine <i>State</i> .

Hysteresis	Sets the amount of hysteresis around the alarm limit. The value entered is an absolute value, and is added to the alarm levels (e.g. <i>Warning</i> , <i>Alert</i> , <i>Danger</i> ) for the alarm to be activated, and subtracted from them for the alarm level to be deactivated. As an example, if <i>Alert</i> level of a <i>Point</i> is set at 4.5, and hysteresis is set at 0.5, the measurement value should be higher than 5 for the point entering into <i>Alert</i> status and go below 4 for the <i>Alert</i> status to be deactivated. Hysteresis helps when the parameter value is close to one of the alarm levels, so that the alarm status does not change too often.
Repetitions	Sets the number of consecutive measurements that is necessary for the measurement to be in a particular alarm level or higher for that alarm level to be activated. Here there are some examples: <ul style="list-style-type: none"> <li>• 0 repetitions (upper type): the alarm will be triggered as soon as the measurement goes above the alarm level.</li> <li>• 1 repetition (upper type): the alarm will be triggered when 2 consecutive measurements are above the alarm level.</li> <li>• 2 repetitions (lower type): the alarm will be triggered when 3 consecutive measurements are below the alarm level.</li> </ul>

### 12.17. Processing Modes

*Processing Modes* are entities that define the way the signal going into a *Dynamic Point* will be sampled and how will this data be processed. They define, for example, the sampling frequency, the acquisition time, filters, spectrum properties, etc.

The *Processing Modes* define therefore the different waveforms to be measured for each channel, and the spectra that will be calculated from them. One single *Dynamic Point* can have multiple *Processing Modes*, e.g. with different sample frequency, length/duration or filtering options. For each *Processing Modes*, the system allows to calculate different *Parameters* (overall values, spectral bands, peak or Peak-to-Peak values, crest factor, etc.).



*Within a Machine all the signals in the unit are always acquired synchronously, despite they come from different Points or Processing Modes, and even if they are captured with different sampling frequency.*

*Processing Modes* perform all this data processing in real-time. This activity needs a lot of CPU resources. To control the amount of resources required, the configuration web has a bar graph that informs about how many *Processing Blocks* is using the current configuration, and how many are available. Each *Processing Mode* of a *Dynamic Point* employs, at least, one *Processing block*.



*Processing Blocks* are limited resources that depend on hardware capacities.

*Pulse tachometer Points* consume 1 processing block

*Static Points* do not consume any processing Blocks

When selecting this menu option, the interface will display the list of *Processing modes* defined currently on the *Dynamic Point* of the *Machine*.

Tag	Name	Type	Frequency		
1kHz	1kHz	Spectrum/Wave	2 - 1000 Hz	⌵	Delete Copy
20kHz		Spectrum/Wave	0 - 20000 Hz	⌵	Delete Copy
iPeak		Demodulation	0 - 1000 Hz	⌵	Delete Copy

New Import

From the list, the *Processing modes* can be deleted or copied by using the corresponding buttons at the right of each item. When the *Copy* button is pressed the interface will ask for the tag of the new *Processing mode* the configuration of the selected one will be copied to.

Do you want to copy this element? Please enter a new tag

Cancel OK

The *Import* button allows on the other hand to copy a *Processing mode* from a different *Machine*, creating a new one of the same type with the configuration of the *Processing mode* selected. When clicking on the *Import* button the interface will display a pull-down menu to select the type of *Processing mode* to be imported.

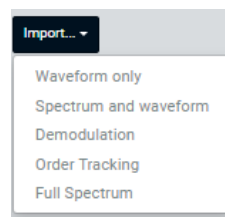

The interface will then display a modal window where the *Machine*, *Point* and *Processing mode* to be copied can be selected. *New tag* field on the other hand defines the tag of the new *Processing mode* that will be created using the configuration of the selected one.

Please select the processing mode to import

Machine\* M1 ⌵

Point\* P1 ⌵

Processing mode\* PM1 ⌵

New tag\* PM3

Cancel Accept

The *New* button creates a new *Processing mode* from scratch. When pressing this button, the interface will ask for the type of *Processing mode* to create (*Waveform only*, *Spectrum and waveform*, *Demodulation*, *Long waveform*, *Order tracking*).

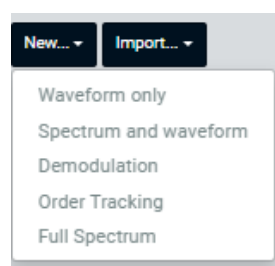

Processing mode	Description
Waveform only	This type of <i>Processing mode</i> measures only a waveform. Sampling frequency and acquisition time can be defined. This <i>Processing mode</i> type does not calculate the spectrum, and no filtering can be applied to the waveform. Indicators/parameters will be calculated from then.
Spectrum and waveform	This type of <i>Processing mode</i> calculates both waveform and spectrum. It allows defining the sampling frequency and the acquisition time of the waveform, and all the different properties of the spectrum. It also allows applying filters.
Demodulation	This <i>Processing mode</i> acquires the waveform and the spectrum by using the <b>demodulation</b> data processing technique. The demodulation is done by using the peak-hold type enveloping.
Long waveform	This <i>Processing mode</i> enables the system to capture and store a long duration waveform, up to 30 minutes. This <i>Processing mode</i> is not measured however on every monitoring period, but only when there is a storage strategy configured to save it on the database. <i>Long waveforms</i> are useful, for example, for storing the full transient event of start-up or for monitoring slow-speed machine.
Full spectrum	This <i>Processing mode</i> calculates the <i>Full spectrum</i> derived from waveforms of two orthogonal probes. Also known as the spectrum of an orbit <i>Full spectrum</i> provides not only the frequency content of the vibration, but also the precession direction at each frequency.
Order tracking (optional features under license)	This <i>Processing mode</i> applies the <i>Order tracking</i> technique to the data. This technique transforms the original asynchronous sampled signal (with a constant sample rate) into a tach-synchronous signal, with the same amount of samples per cycle of shaft revolution. Waveforms measured with <i>Order tracking</i> will have units of angle or cycles, instead of time, and their spectra will be displayed in <i>Order</i> instead of frequency.

After selecting one specific mode, the interface will display the configuration page of the new *Processing mode*. This configuration page can also be displayed to be edited when clicking on any of the existing *Processing mode* of the list.

The following chapters describe the configuration options for each type of *Processing mode* (*waveform only*, *Spectrum and waveform*, *Demodulation*, *Long waveform*, *Order tracking*, etc.).

#### 12.17.1. Waveform only

Tag\*

Name

Description

Type

**Waveform**

Sample rate

Points

Duration 0.85 s

Buffer size 2720 samples

Keep data

**Elements**

Parameters

<b>Field</b>	<b>Description</b>
Tag	Text that unequivocally identifies the <i>Processing Mode</i> within the <i>Point</i> . Only ASCII alphanumeric characters are allowed, including ".", "-", and "_". Any other special characters or blank spaces are not allowed. First character must be alphanumeric. Maximum length is 25 characters.
Name	Text used on the <i>Dashboard</i> to identify the <i>Processing Mode</i> . ASCII alphanumeric characters are allowed, including ".", "-", "_" and blank spaces. If none is given the tag will be used.
Description	Allows the user to include a description of the <i>Processing Mode</i>
Type	Shows the type of <i>Processing Mode</i> .
Sampling rate	Sets the sampling frequency the <i>Processing mode</i> will use. The sampling rate and units are selected from the correspondent pull-down menus. The options available are 320 Hz, 400 Hz, 640 Hz, 800 Hz, 1280 Hz, 1600 Hz, 2560 Hz, 3200 Hz, 5120 Hz, 6400 Hz, 12800 Hz, 25600 Hz and 51200 Hz.
Samples	Sets the number of samples of the waveform that will be stored on the database and shown in the interface. The maximum value allowed is 262016 samples.
Duration	Informs about the time duration of the waveform in seconds. This value will depend on the number of samples and maximum frequency defined for the <i>Processing Mode</i> .
Buffer size	Informs about the number of samples that will be stored at the buffer memory in order to measure the waveform. This value depends on the number of samples defined and the filters required (anti-aliasing).
Keep data	Keeps or discards the waveform measurement after calculating all the parameters associated to the <i>Processing mode</i> . If this checkbox is not enabled the waveform data will not be kept and will not be able to be stored.
Parameters	Shows all the <i>Parameters</i> defined for the dynamic <i>Point</i> . By clicking on any of them the interface will display its configuration page. By clicking on the "... " button the interface will display the list of <i>Parameters</i> . See <a href="#">Parameters</a> for more information about their configuration.

### 12.17.2. Spectrum and waveform

Tag\*   
 Name   
 Description   
 Type

**Spectrum**

Max. frequency    
 Min. frequency    
 Lines   
 Averages   
 Overlap   
 Resolution 6.25 Hz/line  
 Sample rate 12800 Hz  
 Duration 0.17 s  
 Buffer size 2176 samples  
 Window type   
 Property   
 AC detector   
 Keep data



**Waveform**

Points

Duration 0.166 s

Buffer size 2128 samples

Keep data

**Filter**

Enabled

Pass type

Filter type

Order

Cutoff freq.

**Elements**

Parameters [Overall](#) [Unbalance](#) [Misalignment](#) [Looseness](#) [High\\_harmonics](#)  
[PPP](#) [New](#) [...](#)

<b>Field</b>	<b>Description</b>
Tag	Text that unequivocally identifies the <i>Processing Mode</i> within the <i>Point</i> . Only ASCII alphanumeric characters are allowed, including ".", "-", and "_". Any other special characters or blank spaces are not allowed. First character must be alphanumeric. Maximum length is 25 characters.
Name	Text used on the <i>Dashboard</i> to identify the <i>Processing Mode</i> . ASCII alphanumeric characters are allowed, including ".", "-", "_" and blank spaces. If none is given the tag will be used.
Description	Allows the user to include a description of the <i>Processing Mode</i>
Type	Shows the type of <i>Processing Mode</i> .
Max. Frequency	Sets the maximum frequency of the spectrum the <i>Processing mode</i> will measure. The frequency and units are selected from the correspondent pull-down menus. The options available are 125 Hz, 156.25 Hz, 250 Hz, 312.5 Hz, 500 Hz, 625 Hz, 1000 Hz, 1250 Hz, 2000 Hz, 2500 Hz, 5000 Hz, 10000 Hz and 20000 Hz.
Min. Frequency	Sets the minimum frequency of the spectrum the <i>Processing mode</i> will measure. Any value lower than the maximum frequency can be introduced. Its units are selected from the pull-down menu. Options available are Hz and CPM.
Lines	Sets the number of bins or lines of resolution the <i>Processing mode</i> will use to calculate the spectrum. This number is selected from a pull-down menu. The options available are 100, 200, 400, 800, 1600, 3200, 6400 and 12800.
Averages	Sets the number of averages that the <i>Processing mode</i> will use to calculate the spectrum.
Overlap	Sets the overlapping value in % that the <i>Processing mode</i> will use for the averaging process. This number is selected from a pull-down menu. Options available are 0, 15, 25, 33, 50, 67, 75 and 90.
Resolution	Indicates the width of each bin in terms of frequency.
Sample rate	Informs about the sample rate that the device will use internally to calculate the spectrum, according to the number of lines and maximum frequency settings.

Duration	Informs about the time duration of the waveform in seconds that will be required to calculate the spectrum. This value depends on the maximum frequency, number of bins, number of averages and overlap defined for the <i>Processing Mode</i> .
Buffer size	Informs about the number of samples that will be stored at the buffer memory in order to measure the spectrum.
Window type	Selects the type of window that will be applied to the waveform. The options available are <i>Rectangular, Hanning, Hamming, Blackman</i> . By default, this window is set to <i>Hanning</i> .
Property	Selects the property of the spectrum from a pull-down menu. For vibrations measurements the options available are <i>Acceleration, Velocity</i> and <i>Displacement</i> . The signal will be integrated or double integrated if required.
AC detector	Selects the detector to be applied to the spectrum amplitude (RMS, Peak or Peak to Peak).
Keep data	Keeps or discards the spectrum measurement after calculating all the parameters that are extracted from it. If this checkbox is not enabled the spectrum data will not be kept and will not be able to be stored.
Points	Sets the number of points of the waveform that will be shown in the widget interface.
Duration	Informs about the time duration of the waveform in seconds. This value will depend on the number of samples and maximum frequency defined for the <i>Processing Mode</i> .
Buffer size	Informs about the number of samples that will be stored at the buffer memory in order to measure the waveform. This value can be higher than the number of points shown in the interface, because of the internal calculations that are needed for the processing mode. The maximum number allowed is 262016 samples.
Keep data	Keeps or discards the waveform measurement after calculating all the parameters extracted from it. If this checkbox is not enabled the waveform data will not be kept and will not be able to be stored.
Enabled	Defines if a filter will be applied to the <i>Processing mode</i> .
Pass Type	Selects the type of filter to be applied from a pull-down menu. The options available are <i>high pass, low pass, band pass</i> .
Filter Type	Selects the filter to be used from a pull-down menu. The options available are <i>Butterworth, Bessel, Chebyshev</i> .
Order	Selects from a pull-down menu the order of the filter. The options available are 2, 4 or 6.
Cutoff freq.	Sets the cut-off frequency (value and units) of the filter.
Parameters	Shows all the <i>Parameters</i> defined on the <i>Processing mode</i> . By clicking on any of them the interface will display its configuration page. By clicking on the “...” button the interface will display the list of <i>Parameters</i> . See <a href="#">Parameters</a> for more information about their configuration.

**12.17.3. Demodulation**

Tag*	<input type="text" value="Enter value of tag"/>
Name	<input type="text" value="Enter value of name"/>
Description	<input type="text" value="Enter value of description"/>
Type	Demodulation <input type="button" value="v"/>
AC detector	RMS <input type="button" value="v"/>
High-Pass freq.	5000 <input type="button" value="v"/> Hz <input type="button" value="v"/>

**Spectrum**

Max. frequency	5000 <input type="button" value="v"/> Hz <input type="button" value="v"/>
Min. frequency	0 <input type="button" value="v"/> Hz <input type="button" value="v"/>
Bins	400 <input type="button" value="v"/>
Averages	1 <input type="button" value="v"/>
Overlap	75% <input type="button" value="v"/>
Duration	0.09 s
Buffer size	4608 samples
Window type	Hann <input type="button" value="v"/>
Property	Acceleration (Default) <input type="button" value="v"/>
Keep data	<input checked="" type="checkbox"/>

**Waveform**

Samples	<input type="text" value="2000"/>
Duration	0.166 s
Buffer size	2128 samples
Keep data	<input checked="" type="checkbox"/>

**Filter**

Enabled	<input checked="" type="checkbox"/>
Before demodulation	<input type="checkbox"/>
Pass type	Low-pass <input type="button" value="v"/>
Filter type	Butterworth <input type="button" value="v"/>
Order	2 <input type="button" value="v"/>
Cutoff freq.	1000 <input type="button" value="v"/> Hz <input type="button" value="v"/>

**Elements**

Parameters	<input type="button" value="Overall"/> <input type="button" value="Peak-Peak"/> <input type="button" value="..."/>
------------	--

<b>Field</b>	<b>Description</b>
Tag	Text that unequivocally identifies the <i>Processing Mode</i> within the <i>Point</i> . Only ASCII alphanumeric characters are allowed, including ".", "-", and "_". Any other special characters or blank spaces are not allowed. First character must be alphanumeric. Maximum length is 25 characters.
Name	Text used on the <i>Dashboard</i> to identify the <i>Processing Mode</i> . ASCII alphanumeric characters are allowed, including ".", "-", "_" and blank spaces. If none is given the tag will be used.
Description	Allows the user to include a description of the <i>Processing Mode</i>
Type	Shows the type of <i>Processing Mode</i> .
AC detector	...
High-pass freq.	Sets the high pass frequency of the demodulation signal processing. The frequency and units are selected from the correspondent pull-down menus. The options available are 500 Hz, 1000 Hz, 2000 Hz and 5000 Hz.
Max. Frequency	Sets the maximum frequency of the spectrum the <i>Processing mode</i> will calculate as the final step of the demodulation signal process. The frequency and units are selected from the correspondent pull-down menus.
Min. Frequency	Sets the minimum frequency of the spectrum the <i>Processing mode</i> will calculate as the final step of the demodulation signal process. Any value lower than the maximum frequency can be introduced. Its units are selected from the pull-down menu. Options available are Hz and CPM. The options available are 125 Hz, 156.25 Hz, 250 Hz, 312.5 Hz, 500, 625 Hz, 1000 Hz, 1250 Hz, 2000 Hz, 2500 Hz and 5000 Hz.
Bins	Sets the number of bins or lines of resolution the <i>Processing mode</i> will use to calculate the spectrum. This number is selected from a pull-down menu. The options available are 100, 200, 400, 800, 1600, 3200, 6400 and 12800.
Averages	Sets the number of averages that the <i>Processing mode</i> will use to calculate the spectrum.
Overlap	Sets the overlapping value in % that the <i>Processing mode</i> will use for the averaging process. This number is selected from a pull-down menu. Options available are 0, 15, 25, 33, 50, 67, 75 and 90.
Duration	Informs about the time duration of the waveform in seconds that will be required to calculate the spectrum. This value depends on the maximum frequency, number of bins, number of averages and overlap defined for the <i>Processing Mode</i> .
Buffer size	Informs about the number of samples that will be stored at the buffer memory in order to measure the spectrum.
Window type	Selects the type of window that will be applied to the waveform. The options available are <i>Rectangular</i> , <i>Hanning</i> , <i>Hamming</i> , <i>Blackman</i> . By default, this window is set to <i>Hanning</i> .
Property	Selects the property of the spectrum from a pull-down menu. For vibrations measurements the options available are <i>Acceleration</i> , <i>Velocity</i> and <i>Displacement</i> . The signal will be integrated or double integrated if required.
Keep data	Keeps or discards the spectrum measurement after calculating all the parameters that are extracted from it. If this checkbox is not enabled the spectrum data will not be kept and will not be able to be stored.
Samples	Sets the number of samples of the waveform that will be stored on the database and shown in the interface. This value can be higher than the number of samples

	extrictly required to calculate the spectrum. The maximum value allowed is 262016 samples.
Duration	Informs about the time duration of the waveform in seconds. This value will depend on the number of samples and maximum frequency defined for the <i>Processing Mode</i> .
Buffer size	Informs about the number of samples that will be stored at the buffer memory in order to measure the waveform. This value depends on the number of samples defined and the filters required (anti-aliasing).
Keep data	Keeps or discards the waveform measurement after calculating all the parameters extracted from it. If this checkbox is not enabled the waveform data will not be kept and will not be able to be stored.
Enabled	Defines if a filter will be applied to the <i>Processing mode</i> .
Before demodulation	Sets if the filtering will be applied on the signal before or after the demodulation process.
Pass Type	Selects the type of filter to be applied from a pull-down menu. The options available are <i>high pass, low pass, band pass</i> .
Filter Type	Selects the filter to be used from a pull-down menu. The options available are <i>Butterworth, Bessel, Chebyshev</i> .
Order	Selects from a pull-down menu the order of the filter. The options available are 2, 4 or 6.
Cutoff freq.	Sets the cut-off frequency (value and units) of the filter.
Parameters	Shows all the <i>Parameters</i> defined on the <i>Processing mode</i> . By clicking on any of them the interface will display its configuration page. By clicking on the “...” button the interface will display the complete list of <i>Parameters</i> . See <a href="#">Parameters</a> for more information about their configuration.

#### 12.17.4. Long waveform

Tag\*

Name

Description

Type

**Waveform**

Sample rate

Maximum duration  s

Prebuffering  s

Field	Description
Tag	Text that unequivocally identifies the <i>Processing Mode</i> within the <i>Point</i> . Only ASCII alphanumeric characters are allowed, including ".", "-", and "_". Any other special characters or blank spaces are not allowed. First character must be alphanumeric. Maximum length is 25 characters.
Name	Text used on the <i>Dashboard</i> to identify the <i>Processing Mode</i> . ASCII alphanumeric characters are allowed, including ".", "-", "_" and blank spaces. If none is given the tag will be used.
Description	Allows the user to include a description of the <i>Processing Mode</i>
Type	Shows the type of <i>Processing Mode</i> .
Sample rate	Sets the frequency rate the <i>Processing mode</i> will use to sample the waveform. The sampling rate and units are selected from the correspondent pull-down menus. The options available are 400 Hz, 800 Hz, 1600 Hz, 3200 Hz, 6400 Hz and 12800 Hz.
Maximum duration	Sets the time duration of the waveform in seconds that the <i>Processing mode</i> will measure. Maximum value is 1800 seconds.
Prebuffering	Defines the number of seconds that the <i>Processing mode</i> will measure prior to the trigger that initiates the data capturing. Maximum prebuffering setting is 30 seconds.

#### 12.17.5. Order tracking

Tag*	<input type="text" value="Enter value of tag"/>
Name	<input type="text" value="Enter value of name"/>
Description	<input type="text" value="Enter value of description"/>
Type	Order Tracking <input type="button" value="v"/>
AC detector	RMS <input type="button" value="v"/>
Base sample rate	12800 <input type="button" value="v"/> Hz <input type="button" value="v"/>

#### Spectrum

Max. frequency	3.125 <input type="button" value="v"/> orders
Min. frequency	0 <input type="button" value="v"/> orders
Bins	400 <input type="button" value="v"/>
Samples per rev.	8 samples/rev
Required revolutions	128 revs
Max. tachometer freq.	625 Hz (37501 CPM)
Min. tachometer freq.	12.5 Hz (750 CPM)
Window type	Hann <input type="button" value="v"/>
Property	Acceleration (Default) <input type="button" value="v"/>
Keep data	<input checked="" type="checkbox"/>

### Waveform

Samples

Keep data

### Filter

Enabled

Pass type

Filter type

Order

Cutoff freq.

### Elements

Parameters

Field	Description
Tag	Text that unequivocally identifies the <i>Processing Mode</i> within the <i>Point</i> . Only ASCII alphanumeric characters are allowed, including ".", "-", and "_". Any other special characters or blank spaces are not allowed. First character must be alphanumeric. Maximum length is 25 characters.
Name	Text used on the <i>Dashboard</i> to identify the <i>Processing Mode</i> . ASCII alphanumeric characters are allowed, including ".", "-", "_" and blank spaces. If none is given the tag will be used.
Description	Allows the user to include a description of the <i>Processing Mode</i>
Type	Shows the type of <i>Processing Mode</i> .
AC detector	...
Base sample rate	Sets the frequency rate at which the waveform will be initially sampled. The frequency and units are selected from the correspondent pull-down menus. The options available are 320 Hz, 400 Hz, 640 Hz, 800 Hz, 1280 Hz, 1600 Hz, 2560 Hz, 3200 Hz, 5120 Hz, 6400 Hz, 12800 Hz, 25600 Hz, 51200 Hz.
Max. Frequency	Sets in <i>Order</i> units the maximum frequency of the spectrum the <i>Processing mode</i> will measure. This frequency is selected from the correspondent pull-down menu. The options available are 3.125, 6.25, 12.5, 25, 50, 100, 200.
Min. Frequency	Sets in <i>Order</i> units the minimum frequency of the spectrum the <i>Processing mode</i> will measure. Any value lower than the maximum frequency can be introduced.
Bins	Sets the number of bins or lines of resolution the <i>Processing mode</i> will use to calculate the spectrum. This number is selected from a pull-down menu. The options available are 100, 200, 400, 800, 1600, 3200, 6400 and 12800.
Samples per revolution	Informs about the number of samples that the <i>Processing mode</i> will take per revolution after the <i>Order tracking</i> signal processing is performed. This value depends on the maximum frequency selected for the spectrum.

Required revolutions	Informs about the number of revolutions the <i>Processing mode</i> will acquire. This value depends on the maximum frequency and number of bins, or resolution, selected for the spectrum.
Max. Tach. Freq.	Informs about the maximum tachometer frequency that the <i>Processing mode</i> will be able to process.
Min. Tach. Freq.	Informs about the minimum tachometer frequency that the <i>Processing mode</i> will be able to process.
Window type	Selects the type of window that will be applied to the waveform. The options available are <i>Rectangular, Hanning, Hamming, Blackman</i> . By default, this window is set to <i>Hanning</i> .
Property	Selects the property of the spectrum from a pull-down menu. For vibrations measurements the options available are <i>Acceleration, Velocity</i> and <i>Displacement</i> . The signal will be integrated or double integrated if required.
Keep data	Keeps or discards the spectrum measurement after calculating all the parameters that are extracted from it. If this checkbox is not enabled the spectrum data will not be kept and will not be able to be stored.
Samples	Sets the number of samples of the waveform that will be stored on the database and shown in the interface. This value can be higher than the number of samples extrictly required to calculate the spectrum. The maximum value allowed is 262016 samples.
Keep data	Keeps or discards the waveform measurement after calculating all the parameters extracted from it. If this checkbox is not enabled the waveform data will not be kept and will not be able to be stored.
Enabled	Defines if a filter will be applied to the <i>Processing mode</i> .
Pass Type	Selects the type of filter to be applied from a pull-down menu. The options available are <i>high pass, low pass, band pass</i> .
Filter Type	Selects the filter to be used from a pull-down menu. The options available are <i>Butterworth, Bessel, Chebyshev</i> .
Order	Selects from a pull-down menu the order of the filter. The options available are 2, 4 or 6.
Cutoff freq.	Sets the cut-off frequency (value and units) of the filter.
Parameters	Shows all the <i>Parameters</i> defined on the <i>Processing mode</i> . By clicking on any of them the interface will display its configuration page. By clicking on the “...” button the interface will display the list of <i>Parameters</i> . See <a href="#">Parameters</a> for more information about their configuration.



## 12.17.6. Full spectrum

Tag*	<input type="text" value="Enter value of tag"/>
Name	<input type="text" value="Enter value of name"/>
Description	<input type="text" value="Enter value of description"/>
Type	Full Spectrum 

## Spectrum

Process Mode	M1:P1:PM1 
Process Mode 2	M1:P2:PM1 
Keep data	<input checked="" type="checkbox"/>

## Elements

Parameters 

<b>Field</b>	<b>Description</b>
Tag	Text that unequivocally identifies the <i>Processing Mode</i> within the <i>Point</i> . Only ASCII alphanumeric characters are allowed, including ".", "-", and "_". Any other special characters or blank spaces are not allowed. First character must be alphanumeric. Maximum length is 25 characters.
Name	Text used on the <i>Dashboard</i> to identify the <i>Processing Mode</i> . ASCII alphanumeric characters are allowed, including ".", "-", "_" and blank spaces. If none is given the tag will be used
Description	Allows the user to include a description of the <i>Processing Mode</i>
Type	Shows the type of <i>Processing Mode</i> .
Process mode	Selects the first <i>Processing Mode</i> belonging to the current <i>Point</i> whose waveform will be used to calculate the Full spectrum. The pull-down menu will show the available modes defined on the <i>Point</i> .
Process mode 2	Selects the second <i>Processing Mode</i> whose waveform will be used to calculate the Full spectrum. The pull-down menu will show all the available modes defined on the <i>Machine</i> . However only those whose properties (Fmax, Fmin, resolution, averages, etc.) match the ones defined on the Process mode field will be accepted.
Keep data	Keeps or discards the spectrum measurement after calculating all the parameters that are extracted from it. If this checkbox is not enabled the spectrum data will not be kept and will not be able to be stored.
Parameters	Shows all the <i>Parameters</i> defined on the <i>Processing mode</i> . By clicking on any of them the interface will display its configuration page. By clicking on the "... " button the interface will display the list of <i>Parameters</i> . See Parameters for more information about their configuration.

## 12.18. Parameters

VIGILANT defines the entities called *Parameters* as those scalar values that will be calculated from the *Processing Mode*. These *Parameters* are deduced from the spectrum or from the waveform, measured by the corresponding *Processing Mode*, using different algorithms or data processing (overall values, spectral bands, peak or peak-to-peak values, Crest factor, etc.).



Long-Waveform processing modes do not allow to configure any parameter. Anyhow, they can be extracted later using the Dashboard tools.



All the Parameters are measured in real time, along with the corresponding Processing Mode.

By selecting this menu option, the interface will show the list of *Parameters* currently defined on the retained Processing mode.

### Parameters

Tag	Name	Type	Alarms		
<u>* Overall</u>		Spectrum RMS	Upper	⬆ ⬇ ⬆	Delete Copy
<u>Unbalance</u>		Frequency extraction	None	⬆ ⬇ ⬆	Delete Copy
<u>Misalignment</u>		Crest factor	None	⬆ ⬇ ⬆	Delete Copy
<u>Looseness</u>		Spectrum RMS	None	⬆ ⬇ ⬆	Delete Copy
<u>High_harmonics</u>		Spectrum RMS	None	⬆ ⬇ ⬆	Delete Copy

(\*) Main parameter

New
Import

From this list, the *Parameters* can be deleted or copied by using the corresponding buttons (*Delete*, *Copy*) at the right of each item. When the *Copy* button is pressed, the interface will ask to enter the tag of the new *Parameter* that the configuration of the one selected will be copied into.

Do you want to copy this element? Please enter a new tag

Cancel
OK

The up and down arrows, next to the *Delete* button of each item of the list, allows to modify the order of the *Parameters* in the list.

The system defines the first *Parameter* of the first *Processing Mode* as the *Main Parameter* of the *Point*. The list of *Parameters* marks it with an asterisk.



*The Main parameter is the parameter that will be displayed for each Point on the Mimic Widget.*

The *New* button creates a new *Parameter* from scratch. On the other hand, the *Import* button allows copying a *Parameter* from a different *Machine*, *Point* or *Processing mode*, creating a new one with the same configuration of the *Parameter* selected. When clicking on the *Import* button the interface will display a modal window where the *Machine*, *Point*, *Processing mode* and *Parameter* to be copied can be selected. *New tag* field on the other hand defines the tag of the new *Parameter* that will be created using the configuration of the selected one.

Please select the parameter to import

Machine*	<input type="text" value="M1"/>
Point*	<input type="text" value="P1"/>
Processing mode*	<input type="text" value="PM1"/>
Parameter*	<input type="text" value="Overall"/>
New tag*	<input type="text" value="High_freq"/>

Cancel
Accept

When clicking on the *New* button the interface displays the configuration page of the new *Parameter*. This configuration page can also be displayed to be edited when clicking on any of the existing *Parameters* of the list.

### 12.18.1. Parameter types

The following table describes the different types of *Parameters* available on the system.

<b>Type of Parameter</b>	<b>Description</b>
Mean	Measures the DC component of the signal. It is calculated as the average value of the samples.
Waveform RMS	Measures the root mean square value (RMS) from the waveform. The RMS is also known as the quadratic mean and is calculated as the square root of the mean square This value is directly related to the energy content of the vibration.
True Peak	In AC mode this <i>Parameter</i> measures the maximum absolute peak amplitude found on either the positive or negative part of the waveform. In DC coupling mode this <i>Parameter</i> measures the difference between the mean and the maximum peak amplitude from the mean on either side of the waveform.

True Peak to Peak	Measures the difference between the highest and lowest amplitude peaks of the waveform.
Spectrum RMS	Measures RMS value from the spectrum. It could either be calculated from the whole frequency range of the spectrum, or from a single band or set of multiple bands (see <a href="#">Spectral bands</a> ).
Calculated Peak	Measures the theoretical peak value of the signal from its <i>Spectrum RMS</i> value, which in turn can either be calculated from the whole frequency range of the spectrum or by defining one or multiple bands defined. The <i>Calculated peak</i> is calculated by multiplying the <i>Spectrum RMS</i> value by 1.414.
Calculated Peak to Peak	Measures the theoretical peak-to-peak value of the signal from its <i>Spectrum RMS</i> value, which in turn can either be calculated from the whole frequency range of the spectrum or by defining one or multiple bands. The <i>Calculated peak to peak</i> value is calculated by multiplying the <i>Spectrum RMS</i> value by 2.828.
Peak extraction	Measures the amplitude value of the highest peak within a particular frequency range of the spectrum.
Frequency extraction	Measures the frequency of the highest peak within a particular frequency range of the spectrum. This can be useful to determine the speed of the machine by using the spectrum measurements in case the speed frequency or a harmonic stands out from the other peaks around.
Crest factor	Calculates the ratio between the <i>True peak</i> and the <i>Waveform RMS</i> values of a waveform.
Kurtosis	Calculates the so-called “fourth moment” of the signal. This measurement is related to the “tailedness” of the values distribution of the signal.
Peak/Phase (optional)	<p>This is a double <i>Parameter</i> that measures the signal amplitude at a particular frequency and the phase angle (measured in degrees) between the signal filtered at that frequency and a reference trigger signal (provided by a tachometer typically). Phase is measured as the angle difference from the peak of the signal backward in time to the reference trigger point. Phase indicates the deviation in time between two signals.</p> <p>This <i>Parameter</i> needs a minimum tachometer frequency to do the calculations. This frequency is proportional to the <i>Processing Mode</i> sampling rate, increasing with it. The <i>Parameter</i> can be calculated for the tachometer frequency or for a higher order (up to the 4<sup>th</sup> order). This <i>Parameter</i> requires the corresponding license (see <a href="#">Optional software features</a>).</p>
Smax	<i>Smax Parameter</i> measures the maximum peak amplitude of the shaft relative vibration. This parameter is calculated from the orbit, as the maximum amplitude detected at any direction. It requires 2 sensor signals linked together under the same machine component, with the same units and same sampling rate for their <i>Processing modes</i> .

### 12.18.2. Parameter configuration

This section describes the configuration options for the different types of Parameters.

## Mean, Waveform RMS, True Peak, True Peak to Peak

Tag\*

Hidden

Name

Description

Type

Custom unit

Unit

### Limits

Minimum  mV

Maximum  mV

### Elements

Alarms

Field	Description
Tag	Text that identifies unequivocally the <i>Parameter</i> within the <i>Point</i> . Only ASCII alphanumeric characters are allowed, including ".", "-", and "_". Any other special characters or blank spaces are not allowed. First character must be alphanumeric. Maximum length is 25 characters.
Hidden	This option causes the <i>Parameter</i> to be ignored on the <i>Dashboard</i> , so that it will not be displayed on any of its widgets. The value will still be calculated and updated each monitoring cycle, so it can be used for internal calculations (Machine States, Formula points, etc.).
Name	Text used on the <i>Dashboard</i> to identify the <i>Parameter</i> . ASCII alphanumeric characters are allowed, including ".", "-", "_" and blank spaces. If none is given the tag will be used.
Description	Allows the user to include a description of the <i>Parameter</i> .
Type	Selects from a pull-down menu the type of <i>Parameter</i> to measure.
Custom unit	Enables/disables the possibility to select the units for the <i>Parameter</i> measurements by using the pull-down menu <i>Units</i> . In case this checkbox is selected the general system preferences will be ignored and the <i>Parameter</i> will be represented with the units selected in this configuration page.
Unit	Shows the units of the <i>Parameter</i> . By default, the system selects the units of the sensor associated with the corresponding dynamic input. If the <i>Custom unit</i> field is checked the interface allows selecting another unit from the pull-down menu. The options available will be those defined on the Units menu for the corresponding property.

Minimum	Sets the minimum value for the validation range of the measurement. Values outside the validation range are considered bad measurements. They do not trigger alarms and produce an error on the system.
Maximum	Sets the maximum value for the validation range of the measurement. Values outside the validation range are considered bad measurements. They do not trigger alarms and produce an error on the system.

### Spectrum RMS, Calculated Peak, Calculated Peak to Peak

The parameters configured as *Spectrum RMS*, *Calculated peak* and *Calculated peak to peak* are calculated using *Spectral bands*. These *Spectral bands* are independent components of the system that define a frequency range or a set of frequency ranges. These types of *Parameters* can be associated with one or more *Spectral bands*, and its output is calculated as the RMS value, or its derivatives calculated peak or calculated peak to peak values, of the frequencies included in them. In case that no *Spectral bands* are associated with the *Parameter* the system will calculate the *Spectrum RMS*, *Calculated peak* or *Calculated peak to peak* using all the frequencies of the spectrum. The example below shows a *Spectrum RMS* type of *Parameter* named “Unbalance”. This parameter was associated with the *Spectral band* named “1xRPM”. This will make the system calculate the RMS from the spectrum using just the frequency range defined on that *Spectral band* called “1xRPM”.

The screenshot shows the configuration interface for a parameter named "Unbalance". The fields are as follows:

- Tag\***: Unbalance
- Hidden**:
- Name**: Unbalance
- Description**: Enter value of description
- Type**: Spectrum RMS
- Property**: Velocity
- Custom unit**:
- Unit**: mm/s
- Spectral bands**: 1xRPM
- Subtracting spectral bands**:
  - 12x-1kHz
  - GMF\_sidebands
  - Synchronous\_Vib
  - Non\_Synchronous\_Vib
  - 1xRPM
  - 2xRPM
  - 3xRPM
  - 4-12xRPM
- Minimum**: mm/s
- Maximum**: mm/s
- Alarms**: [...]

Multiple *Spectral bands* can be associated with these *Parameters*. In those cases, their value will be calculated using the frequency ranges defined on each of those bands. In the example below a *Parameter* called “misalignment” was configured as *Calculate peak to peak* type. The frequency range of that parameter was defined using the *Spectral bands* 2xRPM and 3xRPM simultaneously, which makes the calculated peak to peak value to be calculated using the spectrum frequencies included on those bands.

Tag*	<input type="text" value="Misalignment"/>
Hidden	<input type="checkbox"/>
Name	<input type="text" value="Misalignment"/>
Description	<input type="text" value="Enter value of description"/>
Type	<input type="text" value="Spectrum RMS"/>
Property	<input type="text" value="Velocity"/>
Custom unit	<input type="checkbox"/>
Unit	<input type="text" value="mm/s"/>
Spectral bands	<input type="text" value="2xRPM, 3xRPM"/>
Subtracting spectral bands	<input type="checkbox"/> 12x-1kHz <input type="checkbox"/> GMF_sidebands <input type="checkbox"/> Synchronous_Vib <input type="checkbox"/> Non_Synchronous_Vib <input type="checkbox"/> 1xRPM <input checked="" type="checkbox"/> 2xRPM <input checked="" type="checkbox"/> 3xRPM <input type="checkbox"/> 4-12xRPM
Minimum	<input type="text" value="mm/s"/>
Maximum	<input type="text" value="mm/s"/>
Alarms	<input type="text"/>



*In case that multiple Spectral bands associated with a parameter have overlapped frequency ranges they will be taken into consideration only once on the calculation of the parameter*

Additionally, the system is able to calculate one or multiple *Spectral bands*, in the same way as explained earlier, but whose value will be subtracted from the value calculated on the field *Spectral band*. This makes it possible for example to create a parameter that monitors the evolution of the difference between 2 particular frequencies or bands. This is done by the field *Subtracting spectral band* and is defined the same way as the field *Spectral band*.

The following image and table show and describes the different fields of the configuration page of this type of *Parameter*.

Tag\*   
 Hidden   
 Name   
 Description   
 Type   
 Property   
 Custom unit   
 Unit   
 Spectral bands   
 Subtracting spectral bands   
**Limits**  
 Minimum  mm/s  
 Maximum  mm/s  
**Elements**  
 Alarms

Field	Description
Tag	Text that identifies unequivocally the <i>Parameter</i> within the <i>Point</i> . Only ASCII alphanumeric characters are allowed, including ".", "-", and "_". Any other special characters or blank spaces are not allowed. First character must be alphanumeric. Maximum length is 25 characters.
Hidden	This option causes the <i>Parameter</i> to be ignored on the <i>Dashboard</i> , so that it will not be displayed on any of its widgets. The value will still be calculated and updated each monitoring cycle, so it can be used for internal calculations (Machine States, Formula points, etc.).
Name	Text used on the Dashboard to identify the Parameter. ASCII alphanumeric characters are allowed, including ".", "-", "_" and blank spaces. If none is given the tag will be used.
Description	Allows the user to include a description of the Parameter.
Type	Selects from a pull-down menu the type of Parameter to measure.
Property	Selects the property of the Parameter from a pull-down menu. For vibration points the options available are Acceleration, Velocity and Displacement. The signal will be integrated or double integrated if required.



Custom unit	Enables/disables the possibility to select the units for the Parameter measurements by using the pull-down menu Units. In case this checkbox is selected the general system preferences will be ignored and the Parameter will be represented with the units selected in this configuration page.
Unit	Shows the units of the Parameter. By default, the system selects the units of the sensor associated with the corresponding dynamic input. If the Custom unit field is checked the interface allows selecting another unit from the pull-down menu. The options available will be those defined on the Units menu for the corresponding property.
Spectral bands	Selects the Spectral bands that define the frequency range used to calculate the value of the Parameter. Multiple spectral bands can be configured using the pull-down menu. The system will use the frequency ranges defined in all of them to calculate the value of the Parameter. See Spectral bands for more information.
Subtracted spectral bands	Selects the Spectral bands that define the frequency range used to calculate a value that will be subtracted from the value calculated on the Spectral band field. Multiple spectral bands can be configured using the pull-down menu. The system will use the frequency ranges defined in all of them to calculate the corresponding value.



*Be aware that the final value of the Parameter will be the subtraction between this Spectral band and the Subtracted spectral band measurements.*

***Value of Parameter = Spectral band value - Subtracting spectral band value***

**Peak extraction, Frequency extraction**

Tag\*

Hidden

Name

Description

Type

Peak order

Peak property

Custom unit

Unit

Minimum frequency

Maximum frequency

Minimum peak height

**Limits**

Minimum

Maximum

<b>Field</b>	<b>Description</b>
Tag	Text that identifies unequivocally the <i>Parameter</i> within the <i>Point</i> . Only ASCII alphanumeric characters are allowed, including ".", "-", and "_". Any other special characters or blank spaces are not allowed. First character must be alphanumeric. Maximum length is 25 characters.
Hidden	This option causes the <i>Parameter</i> to be ignored on the <i>Dashboard</i> , so that it will not be displayed on any of its widgets. The value will still be calculated and updated each monitoring cycle, so it can be used for internal calculations (Machine States, Formula points, etc.).
Name	Text used on the <i>Dashboard</i> to identify the <i>Parameter</i> . ASCII alphanumeric characters are allowed, including ".", "-", "_" and blank spaces. If none is given the tag will be used.
Description	Allows the user to include a description of the <i>Parameter</i> .
Type	Selects from a pull-down menu the type of <i>Parameter</i> to measure.
Peak order	Selects the order that will be associated with the frequency extracted from the spectrum. As an example, if a value of 2 is introduced in this field the system will define the frequency extracted by this parameter as order 2 (2xRPM). In case this Parameter is selected as the one that identifies the speed of the machine the system will identify half its value as the RPM reference of the Machine.
Peak Property	For vibration points the options available are Acceleration, Velocity and Displacement. The signal will be integrated or double integrated if required.
Custom unit	Enables/disables the possibility to select the units for the Parameter measurements by using the pull-down menu Units. In case this checkbox is selected the general system preferences will be ignored and the Parameter will be represented with the units selected in this configuration page.
Unit	Shows the units of the Parameter. If the Custom unit field is checked the interface allows selecting another unit from the pull-down menu. The options available are Hz and CPM.
Minimum frequency	Sets the minimum value of the frequency range the system will use to look for the highest spectrum peak. Once identified the spectrum peak, the system will extract its frequency and amplitude. Interpolation techniques will be used to identify this peak with a higher precision than the one provided by the spectrum resolution.
Maximum frequency	Sets the maximum value of the frequency range the system will use to look for the highest spectrum peak. Once identified the spectrum peak the system will extract its frequency and amplitude. Interpolation techniques will be used to identify this peak with a higher precision than the one provided by the spectrum resolution.
Minimum peak height	Sets the minimum amplitude that will be required to validate the amplitude and frequency extraction. If the amplitude of the highest peak found on the defined frequency range of the spectrum is lower than this value, the system will return a value of 0 for both the frequency and amplitude extraction.
Minimum	Sets the minimum value for the validation range of the measurement. Values outside the validation range are considered bad measurements. They do not trigger alarms and produce an error on the system.
Maximum	Sets the maximum value for the validation range of the measurement. Values outside the validation range are considered bad measurements. They do not trigger alarms and produce an error on the system.

## Crest factor, Kurtosis

Tag\*

Hidden

Name

Description

Type

## Limits

Minimum

Maximum

## Elements

Alarms 

Field	Description
Tag	Text that identifies unequivocally the <i>Parameter</i> within the <i>Point</i> . Only ASCII alphanumeric characters are allowed, including ".", "-", and "_". Any other special characters or blank spaces are not allowed. First character must be alphanumeric. Maximum length is 25 characters.
Hidden	This option causes the <i>Parameter</i> to be ignored on the <i>Dashboard</i> , so that it will not be displayed on any of its widgets. The value will still be calculated and updated each monitoring cycle, so it can be used for internal calculations (Machine States, Formula points, etc.).
Name	Text used on the <i>Dashboard</i> to identify the <i>Parameter</i> . ASCII alphanumeric characters are allowed, including ".", "-", "_" and blank spaces. If none is given the tag will be used.
Description	Allows the user to include a description of the <i>Parameter</i> .
Type	Selects from a pull-down menu the type of <i>Parameter</i> to measure.
Minimum	Sets the minimum value for the validation range of the measurement. Values outside the validation range are considered bad measurements. They do not trigger alarms and produce an error on the system.
Maximum	Sets the maximum value for the validation range of the measurement. Values outside the validation range are considered bad measurements. They do not trigger alarms and produce an error on the system.

## Peak/Phase

Tag\*

Hidden

Name

Description

Type

Peak order  X

Minimum tachometer freq.: Infinity Hz | Infinity RPM

Property

Custom unit

Unit

AC detector

**Limits**

Minimum  mm/s

Maximum  mm/s

Field	Description
Tag	Text that identifies unequivocally the <i>Parameter</i> within the <i>Point</i> . Only ASCII alphanumeric characters are allowed, including ".", "-", and "_". Any other special characters or blank spaces are not allowed. First character must be alphanumeric. Maximum length is 25 characters.
Hidden	This option causes the <i>Parameter</i> to be ignored on the <i>Dashboard</i> , so that it will not be displayed on any of its widgets. The value will still be calculated and updated each monitoring cycle, so it can be used for internal calculations (Machine States, Formula points, etc.).
Name	Text used on the <i>Dashboard</i> to identify the <i>Parameter</i> . ASCII alphanumeric characters are allowed, including ".", "-", "_" and blank spaces. If none is given the tag will be used.
Description	Allows the user to include a description of the <i>Parameter</i> .
Type	Selects from a pull-down menu the type of <i>Parameter</i> to measure.
Peak order	Selects the order frequency ( $n^{\circ}$ of times the Machine speed) that will be used to calculate the peak and phase measurements. The value must be any positive integer value up to 100x.
Minimum tachometer freq.	Informs about the minimum tachometer frequency that the system requires to calculate the peak and phase measurements.
Property	Selects the property of the <i>Parameter</i> from a pull-down menu. For vibration points the options available are Acceleration, Velocity and Displacement. The signal will be integrated or double integrated if required.
Custom unit	Enables/disables the possibility to select the units for the <i>Parameter</i> measurements by using the pull-down menu Units. In case this checkbox is

	selected the general system preferences will be ignored and the Parameter will be represented with the units selected in this configuration page.
Unit	Shows the units of the Parameter. If the Custom unit field is checked the interface allows to select another unit from the pull-down menu.
Ac detector	Selects the detector defined for the amplitude of the peak measurement. The options available are RMS, Peak and Peak to peak.
Minimum	Sets the minimum value for the validation range of the amplitude part of the Parameter. Values outside the validation range are considered bad measurements. They do not trigger alarms and produce an error on the system.
Maximum	Sets the maximum value for the validation range of the amplitude part of the Parameter. Values outside the validation range are considered bad measurements. They do not trigger alarms and produce an error on the system.

**Smax**

Tag\*

Hidden

Name

Description

Type

Process Mode

Custom unit

Unit

**Limits**

Minimum  G

Maximum  G

<b>Field</b>	<b>Description</b>
Tag	Text that identifies unequivocally the <i>Parameter</i> within the <i>Point</i> . Only ASCII alphanumeric characters are allowed, including ".", "-", and "_". Any other special characters or blank spaces are not allowed. First character must be alphanumeric. Maximum length is 25 characters.
Hidden	This option causes the <i>Parameter</i> to be ignored on the <i>Dashboard</i> , so that it will not be displayed on any of its widgets. The value will still be calculated and updated each monitoring cycle, so it can be used for internal calculations (Machine States, Formula points, etc.).
Name	Text used on the <i>Dashboard</i> to identify the <i>Parameter</i> . ASCII alphanumeric characters are allowed, including ".", "-", "_" and blank spaces. If none is given the tag will be used.
Description	Allows the user to include a description of the <i>Parameter</i> .
Type	Selects from a pull-down menu the type of <i>Parameter</i> to measure.

Process mode	Selects the second <i>Process mode</i> that will be used, along with the one from which this <i>Parameter</i> is being added, to calculate the Smax value. The pull-down menu will show only those <i>Processing modes</i> of the different points of the <i>Machine</i> that are compatible with the current one. Both <i>Processing modes</i> require for example to have the same sampling frequency and units.
Custom unit	Enables/disables the possibility to select the units for the Parameter measurements by using the pull-down menu Units. In case this checkbox is selected the general system preferences will be ignored and the Parameter will be represented with the units selected in this configuration page.
Unit	Shows the units of the Parameter. If the Custom unit field is checked the interface allows selecting another unit from the pull-down menu.
Minimum	Sets the minimum value for the validation range of the amplitude part of the Parameter. Values outside the validation range are considered bad measurements. They do not trigger alarms and produce an error on the system.
Maximum	Sets the maximum value for the validation range of the amplitude part of the Parameter. Values outside the validation range are considered bad measurements. They do not trigger alarms and produce an error on the system.

## 12.19. Spectral Bands

*Spectral bands* are objects included in the machine configuration that define different frequency ranges used to calculate *Spectrum RMS*, *Calculated peak* and *Calculated peak to peak* type parameters.

By selecting this menu option, the interface will show the list of *Spectral bands*. From this list they can be added, removed, and configured.

Name	Type	Freq	Harmonics	Reversed	Stop band	
<a href="#">12xRPM-1kHz</a>	Single band	11.5 * "speed" - 1000	-	No	No	Delete Copy
<a href="#">1xRPM</a>	Single band	0.5 * "speed" - 1.5 * "speed"	-	No	No	Delete Copy
<a href="#">2xRPM</a>	Single band	1.5 * "speed" - 2.5 * "speed"	-	No	No	Delete Copy
<a href="#">3x-12xRPM</a>	Single band	2.5 * "speed" - 12.5 * "speed"	-	No	No	Delete Copy
<a href="#">50Hz-StopBand</a>	Harmonic family	50	1x - 20x	No	Yes	Delete Copy
<a href="#">GMF_Side_Bands</a>	Side Bands	21 * "speed"	1x - 5x	No	No	Delete Copy
<a href="#">Non_Synchronous_Vib</a>	Harmonic family	"speed"	1x - 50x	Yes	No	Delete Copy
<a href="#">Synchronous_Vib</a>	Harmonic family	"speed"	1x - 50x	No	No	Delete Copy

New

By clicking on one of the items the interface will show its configuration. There are three types of *Spectral Bands* that can be configured: *Single Band*, *Harmonic Family* and *Sidebands*.

Type	Description
Single Band	The single band type of spectral band defines a frequency range using a minimum and maximum frequency.
Harmonic Family	This type of spectral band defines a set of frequency ranges based on a family of harmonics of a fundamental frequency.

Sidebands	This type of spectral band defines a set of frequency ranges based on the definition of the sidebands around a central frequency.
-----------	---

### 12.19.1. Single Band

The *Single Band* type of *Spectral Bands* defines a single frequency range between 2 frequencies of the spectrum. This can be done using either a minimum and maximum frequency or by a central frequency and a bandwidth.

**Spectral band 1xRPM**

Name\*

Description

Type Single Band ▼

Centered

Min frequency (Hz)  Edit

Max frequency (Hz)  Edit

Reversed

Stopband

**Spectral band 1xRPM**

Name\*

Description

Type Single Band ▼

Centered

Central frequency (Hz)  Edit

Bandwidth (Hz)  Edit

Reversed

Stopband

Field	Description
Name	Sets the unique name of the <i>Spectral band</i> .
Description	Defines the description of the <i>Spectral band</i> .
Min. Frequency	Sets the minimum frequency of the band. This value can be defined by introducing a value in Hz, or by the result of a formula, whose result will also be in Hz units. Click on <i>Edit</i> button to edit this field.

Max. Frequency	Sets the maximum frequency of the band. This value can be defined by introducing a value in Hz, or by the result of a formula, whose result will also be in Hz units. Click on <i>Edit</i> button to edit this field.
Central Frequency	Sets the center frequency of the band to be defined. This field appears only if <i>Centered</i> check box is marked.
Bandwidth	Sets the width of the band to be defined. This field appears only if <i>Centered</i> check box is marked.
Reversed	By checking this box, the frequency range is defined including all the frequencies of the spectrum except the ones defined on this configuration form.
Stopband	By checking this box, the frequency range defined on this configuration form will not be taken into account on the calculation of the <i>Spectrum RMS</i> parameter associated with this <i>Spectral band</i> .

The following example shows a frequency range defined as a single band with a minimum and maximum frequency of 1.5 and 2.5 times the speed respectively.

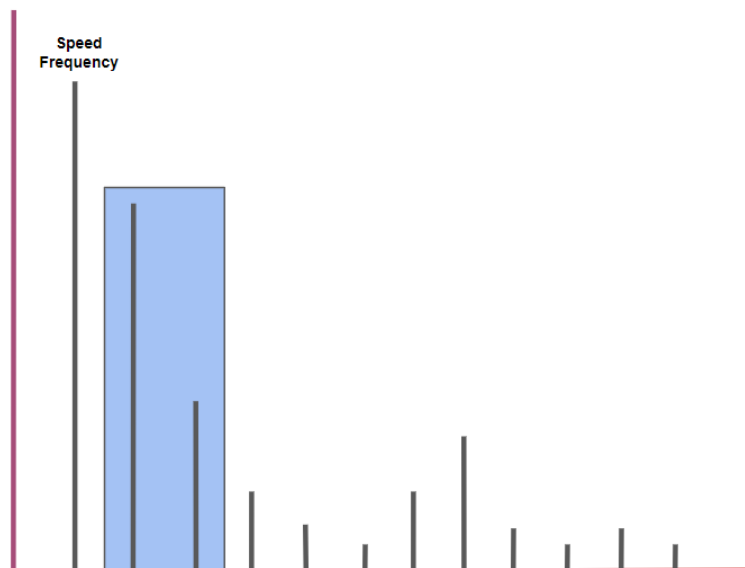

Minimum, maximum and central frequencies, as well as the bandwidth, can be defined as fixed values or by using [Logical Expressions](#). Those fields can be changed by clicking on the Edit button. The [Expression Editors](#) will appear, allowing the user to introduce any value or expression.

This formula editor helps the user by providing the list of variables and operators available on the system. Selecting one of them from the corresponding pull-down list the editor will automatically insert the variable or operator into the expression. The system checks automatically if the syntaxes of the expression are correct. If not, it shows an Invalid Expression message.



These expressions make it possible to define the frequency band as a function of the speed of the point.

### 12.19.2. Harmonic Family

This type of *Spectral band* defines a set of frequency ranges based on a family of harmonics of a fundamental frequency.



The following image shows an example of this type of *Spectral bands* definition. On it a set of frequency ranges was defined as a family of the speed frequency and its harmonics (up to 50), with a bandwidth of 5 Hz.

The image shows a configuration window titled "Spectral band Synchronous\_Vib". It contains the following fields and controls:

- Name\***: Text input field containing "Synchronous\_Vib".
- Description**: Text input field containing "Synchronous\_Vib".
- Type**: Dropdown menu set to "Harmonic Family".
- Fundamental frequency (Hz)**: Text input field containing "speed" with an "Edit" button to its right.
- First harmonic**: Text input field containing "1" with an "X" button to its right.
- Last harmonic**: Text input field containing "50" with an "X" button to its right.
- Bandwidth (Hz)**: Text input field containing "5" with an "Edit" button to its right.
- Reversed**: A checkbox that is currently unchecked.
- Stopband**: A checkbox that is currently unchecked.

<b>Field</b>	<b>Description</b>
Name	Sets the unique name of the <i>Spectral band</i> within the <i>Machine</i> . This text will be used on the <i>Dashboard</i> to identify the <i>Parameter</i> . ASCII alphanumeric characters are allowed, including ".", "-", "_" and blank spaces.
Description	Allows the user to include a description of the <i>Spectral band</i> .
Fundamental frequency	Sets the fundamental frequency of the harmonic family. This value can be defined by introducing a value in Hz, or by the result of a formula, whose result will also be in Hz units. Click on <i>Edit</i> button to edit this field.
First harmonic	Sets the value of the first harmonic that will define the band. A value of 1 defines the fundamental frequency.
Last harmonic	Sets the value of the last harmonic that will define the band.
Bandwidth	Sets the width of the bands. This value can be defined by introducing a value in Hz or by the result of a formula, whose result will also be in Hz units. Click on <i>Edit</i> button to edit this field.
Reversed	By checking this box, the frequency range is defined as all the frequencies of the spectrum except the ones defined by the harmonic family.
Stopband	By checking this box, the frequency ranges defined by the harmonic family will not be taken into account on the calculation of the parameter associated with this spectral band.

The following image shows the frequency ranges of a *Spectral band* configured as a *Harmonic family*, with its fundamental frequency, its bandwidth, and the first and last harmonics set as 3 and 11 respectively.

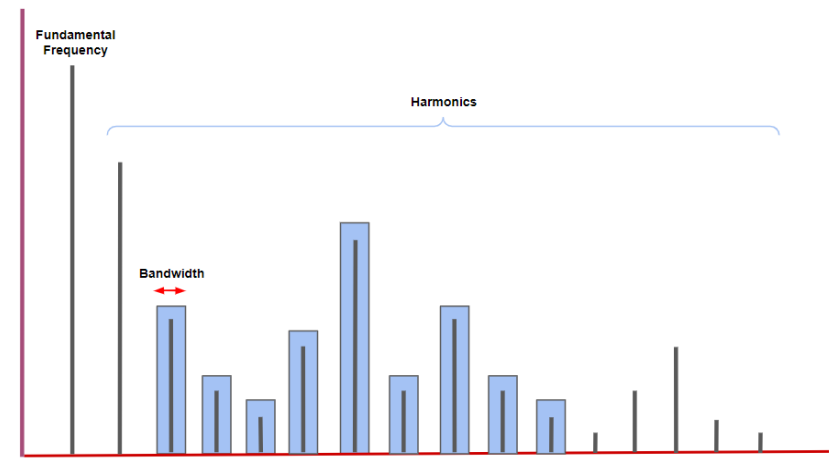

This other example below shows a *Spectral band* defined as a *Harmonic family*, with the fundamental frequency set as the speed frequency, its bandwidth configured as a fifth of the speed and the first and last harmonic set as 1 and 16 respectively. In this case the *Reversed* checkbox was activated in order to calculate the non-synchronous vibration.

**Spectral band Non\_Synchronous\_Vib**

Name\*

Description

Type Harmonic Family ▼

Fundamental frequency (Hz)  Edit

First harmonic  X

Last harmonic  X

Bandwidth (Hz)  Edit

Reversed

Stopband

The picture below shows the frequency ranges defined with this configuration above.

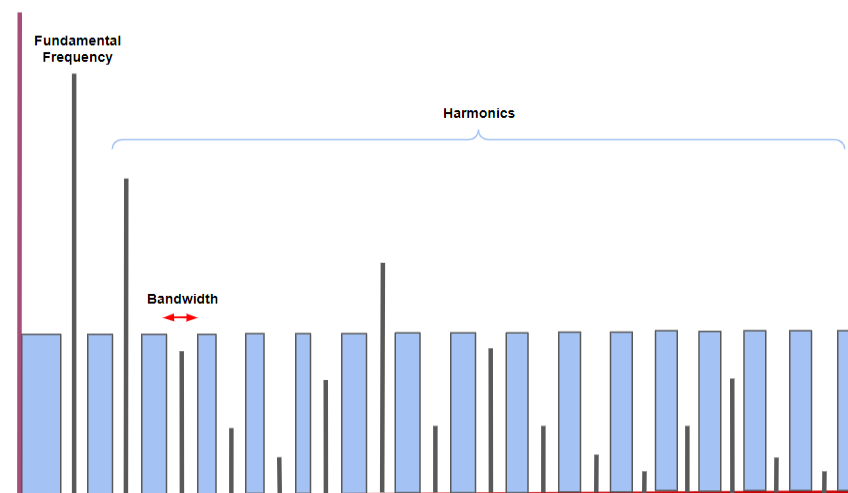

In this other example a Parameter was configured where two Spectral bands were defined. The first one was configured with a frequency range of the full spectrum, and the second one as a Harmonic family, with the fundamental frequency set as 50 Hz, 4 harmonics of that fundamental frequency and with the Stopband option enabled. This Parameter measures the spectrum overall value with the first 4 harmonics of 50 Hz removed. This can be useful for example in case too much electrical noise is present on the signal and is required to remove it from the overall value or any other Parameter.

Spectral bands 0-Fmax, 50Hz\_harmonics ▾

- 1x
- 2x
- 3-12x
- 13x-Fmax
- 1-20kHz rr
- 0-Fmax
- 50Hz\_harmonics

Minimum G

Maximum G

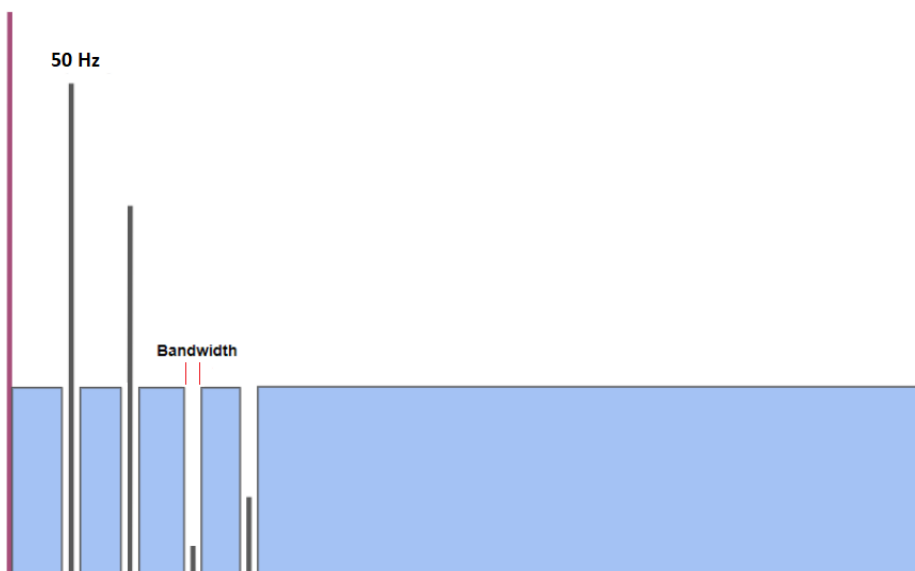

Name\*

Description

Type Harmonic Family ▾

Fundamental frequency (Hz)  Edit

First harmonic  X

Last harmonic  X

Bandwidth (Hz)  Edit

Reversed

Stopband

### 12.19.3. Sideband

This type of *Spectral band* defines a set of frequency ranges based on sidebands from a central frequency.

**New spectral\_band**

Name\*

Description

Type Sidebands

Central frequency (Hz)

Sidebands distance (Hz)

First sideband

Last sideband

Sidebands side Both

Bandwidth (Hz)

Reversed

Stopband

Field	Description
Name	Sets the unique name of the Spectral band within the Machine. This text will be used on the Dashboard to identify the Parameter. ASCII alphanumeric characters are allowed, including ".", "-", "_" and blank spaces.
Description	Allows the user to include a description of the Spectral band.
Central frequency	Sets the central frequency of the sideband. This value can be defined by introducing a numerical value in Hz or by an expression, whose result will also be in Hz units. Click on Edit button to edit this field.
Sideband distance	Sets the distance in Hz between the sidebands.
First sideband	Sets the value of the first sideband. For example, a value of 3 will set as the first sideband a frequency of 3 times the sideband distance from the central frequency.
Last sideband	Sets the value of the last sideband. For example, a value of 6 will set as the last sideband a frequency of 6 times the sideband distance.
Sidebands side	Defines if only left, right or both sidebands around the central frequency will be taken into account.
Bandwidth	Sets the width of the band to be defined around each sideband. This value can be defined by introducing a value in Hz, or by the result of a formula, whose result will also be in Hz units. Click on Edit button to edit this field.
Reversed	By checking this box, the frequency range is defined as all the frequencies of the spectrum except the ones defined on this form.

Stopband	By checking this box, the frequency range defined will not be taken into account on the calculation of the parameter associated with this spectral band.
----------	--

The following image shows an example of this type of *Spectral bands* where a set of frequency ranges was configured with a central frequency of 21 times the speed, 5 sidebands to the left and right with a bandwidth of 2 Hz, and the sideband distance set as the speed frequency.

**Spectral band GMF\_Side\_Bands**

Name\*

Description

Type Sidebands

Central frequency (Hz)

Sidebands distance (Hz)

First sideband

Last sideband

Sidebands side Both

Bandwidth (Hz)

Reversed

Stopband

The following images show a set of frequency ranges defined as a *Sideband* type of *Spectral band*. In this example the central frequency was set at 100 Hz, with sidebands 2 to 4 at both sides, a bandwidth of 5 Hz and a sideband distance of 10 Hz.

Name\*

Description

Type Sidebands

Central frequency (Hz)

Sidebands distance (Hz)

First sideband

Last sideband

Sidebands side Both

Bandwidth (Hz)

Reversed

Stopband

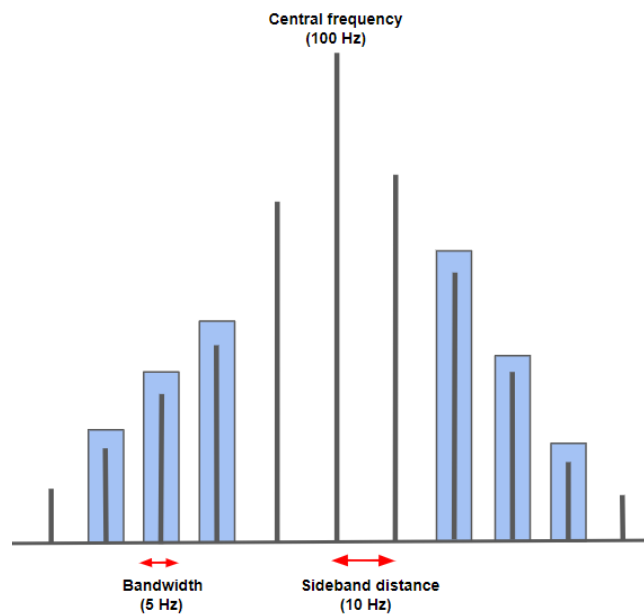

## 12.20. States

*States* are objects included in the machine configuration that define the different machine conditions the *Vigilant* will consider. They allow the user to configure particular [Storage Strategies](#) and alarm limits depending on these different machine conditions or states.

By selecting this menu option, the interface will show the list of States. From this list they can be added, removed, and configured.

### States

Name	Number	Condition	
<a href="#">Stopped</a>	0		<button>Copy</button>
<a href="#">Running</a>	1	"M1V:Overall:value" > 100	<button>Delete</button> <button>Copy</button>

New

*States* are evaluated based on [Logical Expressions](#). The evaluation of those expressions is done following the order of the machine State list. If one of the expressions is true, then the rest of the State expressions will not be evaluated. So that the machine will take the State whose expression comes true first.



The first *state* of the list is the default one and it is created automatically for each machine. Its name can be changed but it cannot be removed and does not have any expression associated with it. The machine will be set into this State if the other States' expressions are not true.

The following picture shows the configuration page of the *States*.

**State** Running

Name\*

Description

Condition  Edit

Cancel
Accept

Field	Description
Tag	Text that identifies unequivocally the <i>State</i> . Only ASCII alphanumeric characters are allowed, including ".", "-", and "_". Any other special characters or blank spaces are not allowed. First character must be alphanumeric. Maximum length is 25 characters.
Description	Allows the user to include a description of the <i>State</i> .
Condition	Sets the logical expression that define the <i>State</i> condition. If the result is true, the machine will be set to that <i>State</i> . If not, the system will evaluate the expression of the following machine <i>State</i> of the list. By clicking on the <i>Edit</i> button, a modal window will be displayed where the expression can be introduced. See the <a href="#">Expression Editor</a> for more information.

## 12.21. Storage Strategies

Storage strategies are objects, included in the Machine configuration, that define the data to be stored on the database and the conditions that produce that storage.

When selecting this menu option, the interface displays the list of Storage strategies. From this list they can be deleted or copied by using the corresponding buttons (Delete, Copy) at the right of each item. The up and down arrows next to the Delete button of each item of the list on the other hand allows to modify the order of the Storage strategies in the list.

**Storage strategies**

Name	Event	Condition	Delay	
<a href="#">Strategy_1</a>	Time period	Every 2 hours	true	0 s <span style="float: right;">⬇️ <span style="background-color: #f00; color: white; padding: 2px 5px;">Delete</span> <span style="background-color: #ccc; padding: 2px 5px;">Copy</span></span>
<a href="#">Strategy_2</a>	Time period	Every 2 minutes	true	0 s <span style="float: right;">⬆️ <span style="background-color: #f00; color: white; padding: 2px 5px;">Delete</span> <span style="background-color: #ccc; padding: 2px 5px;">Copy</span></span>

New

When the *Copy* button is pressed the interface asks to enter the tag of the new *Storage strategy* that the configuration of the one selected will be copied into.

Do you want to copy this element? Please enter a new name

Cancel
OK

The *New* button creates on the other hand a new *Storage strategy* from scratch. When clicking on the *New* button the interface will display the configuration page of the new *Storage strategy*. This

configuration page can also be displayed to be edited when clicking on any of the existing Parameters of the list.

Field	Description
Name	Text that identifies unequivocally the <i>Storage Strategy</i> . Only ASCII alphanumeric characters are allowed, including ".", "-", and "_". Any other special characters or blank spaces are not allowed. First character must be alphanumeric. Maximum length is 25 characters.
Description	Allows the user to include a description of the <i>Storage Strategy</i>
Type	Defines the type of event that triggers the data storage. In addition to this event the expression defined in the <i>Condition</i> field must be true to actually store the data. These are the type of events available on the system: <ul style="list-style-type: none"> <li>• <i>Time Period</i>. Defines a time period event for the data storage.</li> <li>• <i>Monitoring cycles</i>. Sets the data storage events based on the monitoring cycles defined for the <i>Machine</i>, on its field <i>Monitoring period</i>. (<u>Optional software features</u>)</li> <li>• <i>State change</i>: Sets the storage event based on a <i>State</i> change of the <i>Machine</i>. The user will be able to choose the initial and final machine <i>State</i> that will trigger this storage event. (<u>Optional software features</u>)</li> <li>• <i>Alarm change</i>: Defines a storage event based on a change in the alarm condition of the <i>Machine</i>. The user will be able to choose the minimum alarm condition that will trigger this event. As an example, selecting a value of <i>Alert</i> will trigger the storage event when the <i>Machine</i> goes into <i>Alert</i> or <i>Danger</i> alarm, but not if it goes from OK into <i>Warning</i> condition. (<u>Optional software features</u>)</li> <li>• <i>Advanced (cron line)</i>: Allows to introduce a time event based on a <u>Cron command</u>.</li> </ul>
Every	Sets the time period, in minutes or hours, to store the data in case <i>Time period</i> option is selected for the type of event. It also defines the number of cycles that triggers the storage event in case the <i>Monitoring cycles</i> option is selected.
From State	Sets the initial <i>State</i> of the machine <i>State change</i> event. This field only appears in case <i>State change</i> option is selected for the type of event.



To State	Sets the final <i>State</i> of the machine <i>State change</i> event. This field only appears in case <i>State change</i> option is selected for the type of event.
Alarm level	Sets the minimum alarm condition of the <i>Machine</i> that will trigger the <i>Alarm change</i> event. This field only appears in case <i>Alarm change</i> option is selected for the type of event.
Cron line	Defines the expression of the Cron command. This expression sets the date and time when the storage event will be triggered. E.g.: <ul style="list-style-type: none"> <li>• cron */5 * * * tue (every 5 minutes on Tuesday)</li> <li>• cron 5 * (every hour at hh:05)</li> <li>• cron * (every minute)</li> <li>• cron 50 12 * * * (every day at 12:50)</li> </ul> This field only appears in case Advance (cron line) option is selected for the type of event.
Condition	Defines a logical expression that must be true in order for the Storage strategy to actually store the data when an event is triggered. By clicking on the Edit button, the interface will display a modal window with the expression editor. See Expression Editors for more information.
Discard if	Specifies, using a logic expression, which conditions should be met to discard the capture data, avoiding its storage. By clicking on the Edit button, the interface will display a modal window with the expression editor. See Expression Editors for more information.
Advanced	By enabling this option, the storage of each waveform and spectrum for the different Points and Processing Modes will depend on a condition defined by a logical expression.
Save Waveform	Sets whether the waveform will be stored for each Point and Processing Mode. If Advanced mode is selected an Edit button will appear by each waveform. By clicking on Edit button, the interface will display a modal window with the expression editor. See Expression Editors for more information.
Save Spectrum	Sets whether the spectrum will be stored for each Point and Processing Mode. If Advanced mode is selected an Edit button will appear by each spectrum. By clicking on Edit button, the interface will display a modal window with the expression editor. See Expression Editors for more information.



*The Storage strategies always store the Parameters, regardless of the storage configuration for the different spectra and waveforms.*



*Minimum effective period in between two storage operations depend on several factors, like the CPU load, number of Processing Modes being used, number of records already in memory, etc.*



*When the storage event is triggered, the system will check if the condition defined on the Storage Strategy is true. In that case the last data measured will be stored (it does not require a new measurement to be performed).*

## 13. Dashboard

### 13.1. Introduction

The *Dashboard* allows the user to display the data measured and/or stored on the *Vigilant* unit. It also shows the historical or currently active alarms present on the system.

The *Dashboard* displays the data on windows called *Widgets*. The area where these *Widgets* are located is called *Desktop*. Each *Dashboard* can contain up to 20 different *Desktops*. The layout of each *Desktop* defines the number of *Widgets*, their size and location.

This section shows how to use the *Dashboard* to:

- Show and manage alarms.
- Create and edit *Desktops*.
- Use and configure the different type of *Widgets*.

### 13.2. Dashboard Layout

The following picture shows an example of *Dashboard* and its different components.

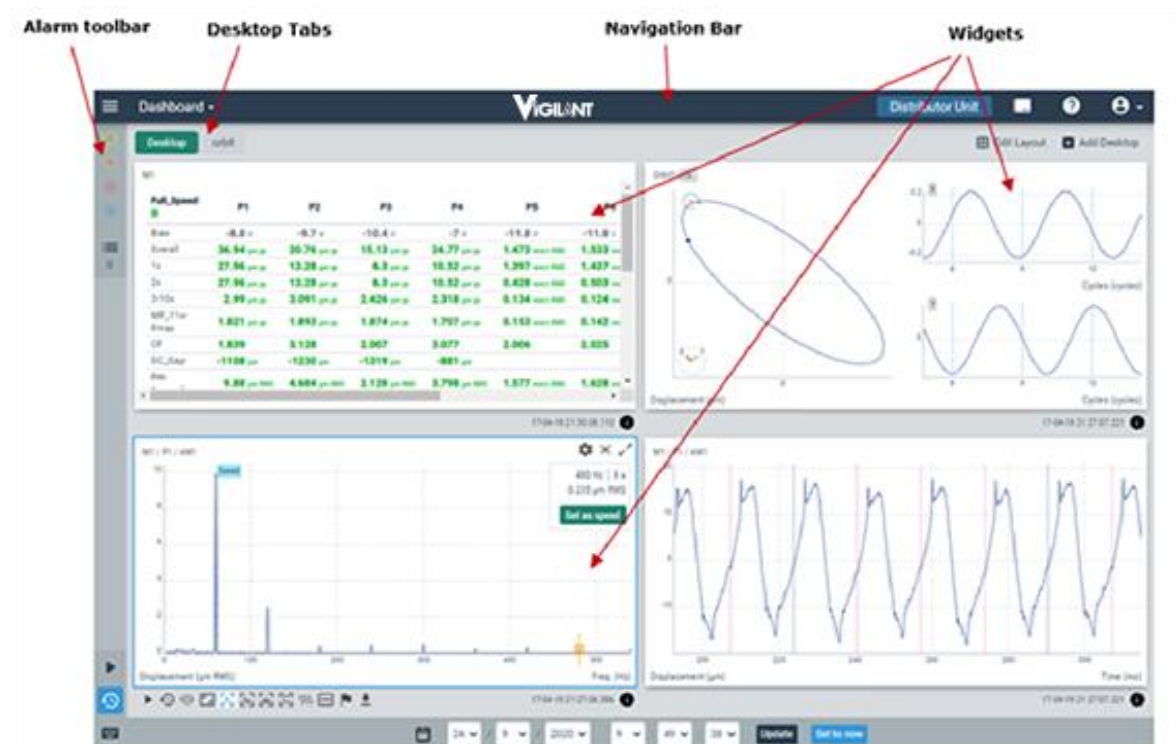

#### 13.2.1. Desktop Toolbar

The *Desktop Toolbar* is used to access the different *Desktops* of the *Dashboard*.

The left part of the *Toolbar* shows the name of the *Desktops* available. Clicking on them will update the *Desktop* area with the corresponding layout of *Widgets*.

The buttons on the right part of the *Toolbar* (Edit Layout, Add Desktop) are used to edit the layout of the current *Desktop* and add new ones (see *Edit desktop layout*).



On the example below, the *Dashboard* is composed of 4 *Desktops* called General, Spectra, Trend and Waveform, and shows the layout and *Widgets* of the one called Spectra.



The area below the *Toolbar* is used for placing the *Widgets* of the *Desktop*. It can contain multiple *Widgets*, and each of them can have a different size and be of a different type.

The following Chapter shows how to define the layout of the *Desktop* and how to select the type of its *Widgets*.







### 13.2.2. Edit Desktop Layout

The layout of the *Desktop* can be changed by the user. The changes made will only affect that particular user. Each user can have their own customized *Desktops* and layouts.

The button *Edit Layout* of the *Toolbar* will show the *Desktop* in edit mode, allowing the user to delete it, change its name or change the configuration of the *Widgets* layout. The following image shows the *Desktop* in edit mode.

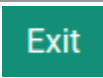

The following table defines the different options.

<b>Option</b>	<b>Description</b>
Edit Name	Edits the name of the <i>Desktop</i> . A pop/up window will appear. Introduce the new name and click on the <i>Accept</i> button to change the name or click on <i>Cancel</i> button otherwise.
Delete Desktop	Deletes the <i>Desktop</i> . A popup window will appear to confirm the actions. Click the <i>Accept</i> button to delete the <i>Desktop</i> or cancel otherwise.
	Splits the <i>Widget</i> vertically in 2 equal parts.
	Splits the <i>Widget</i> horizontally in 2 equal parts.
	Merges 2 <i>Widgets</i> horizontally into one.
	Merges 2 <i>Widgets</i> horizontally into one.
	Merges 2 <i>Widgets</i> vertically into one.
	Merges 2 <i>Widgets</i> vertically into one.
	Exit the edit mode of the <i>Desktop</i> .

The *Split* and *Merge* buttons will only appear when the mouse passes over *Widget*, on its top left corner. When you merge one widget over another, the resulting widget will have the same functionality as the first one where the button was pressed.

Split buttons will only appear if the *Widget* is big enough to be split into 2 parts.

### 13.2.3. Split Widgets

The following images show some examples of how to split *Widgets*, creating new ones on the process.

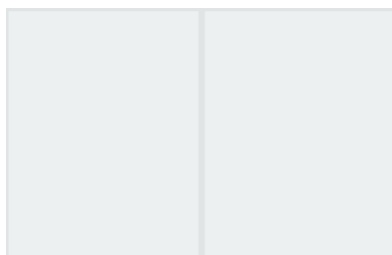



The process can continue as necessary for each individual new *Widget*, to create the number of *Widgets* and layout required by the user.

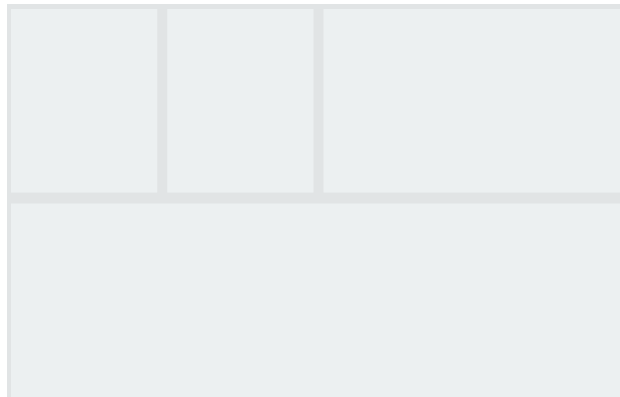

The split buttons will divide the *Widget* into 2 equal ones. The size of each one can be changed though by using the vertical and horizontal division lines.

Passing the mouse over will turn those division lines into green, meaning its position can be changed. Click on them and move it into a new position, changing the size of the *Widgets* at both sides of the line, either vertically or horizontally.

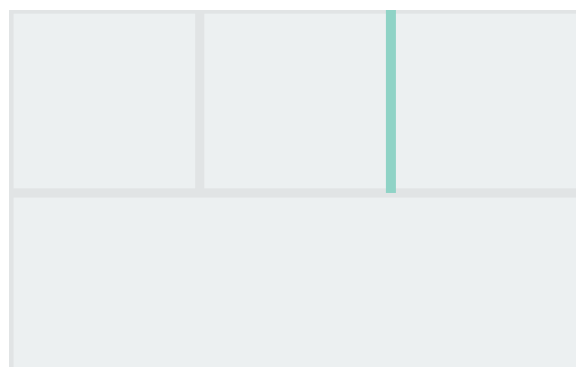
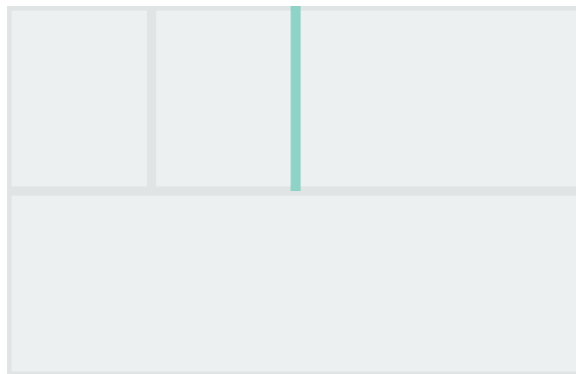

### 13.2.4. Merge Widgets

The splitting of the *Desktop* changes can be reversed by using the *Merge* buttons. These buttons join 2 *Widgets* back into one.



For merging two *Widgets*, they must have been split previously. It is not possible to merge *Widgets* that are not related one to another.

The following images show an example.

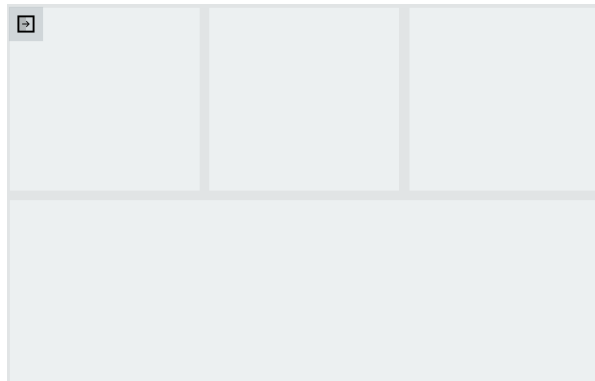

Clicking on the *Merge Horizontal* button will join both *Widgets* into a single one, as shown below.

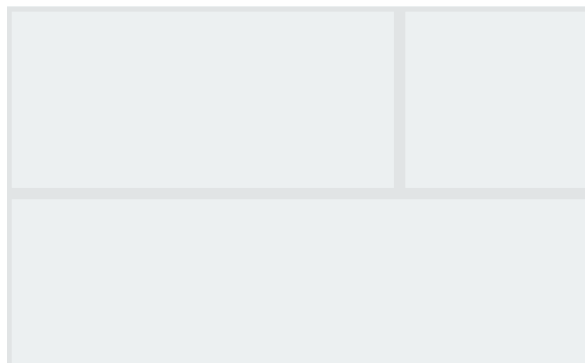

Once the number of *Widgets* and layout has been defined click on *Exit* button to return to the normal *Desktop* mode.

### 13.2.5. Select type of Widget

Once the layout has been defined the user can assign a particular type of *Widget* to the different windows of the *Desktop* layout. The following picture shows an example where no *Widgets* have been assigned to each *Window*.

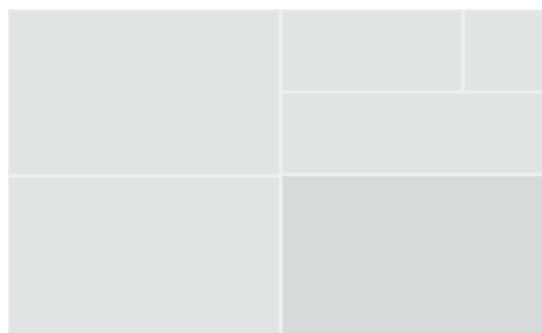

Clicking on an empty one, a window will appear, showing the different type of [Widgets](#) available, and enabling to use the space for its functionality. Select the corresponding type of *Widget* that will be assigned to the corresponding window (spectrum on the example below).

The *Widget* will show “No Configuration”. By default, no data-source is assigned to the *Widget*. Go to its configuration in order to select the source of data that the *Widget* will present (see *Widgets*).

### 13.2.6. Add Desktop

The button Add Desktop of the Toolbar adds a new one. Clicking on it the following pop-up window will appear.

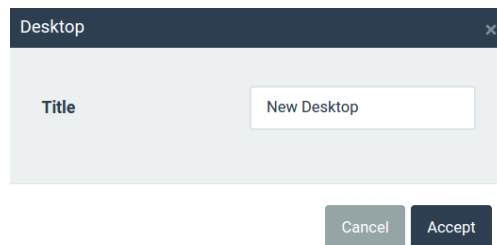

Introduce the name on the field *Title* and click on the *Accept* button to create the new *Desktop*. Click on *Cancel* to abort the process.

Once it has been created the *Desktop* will show a single *Widget*, filling all its area. See “*Edit desktop layout*” in order to add new *Widgets* or change its layout.

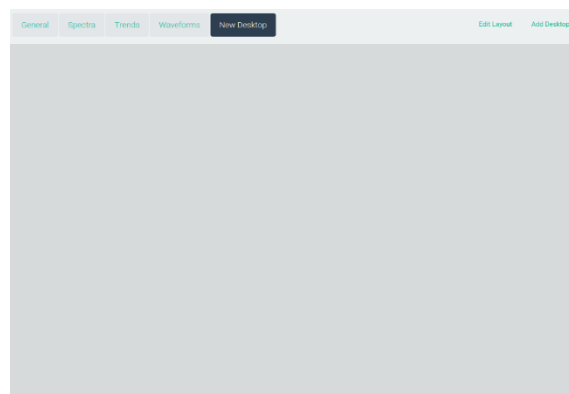

### 13.2.7. Alarm Toolbar

The *Alarm Toolbar* shows the number of alarms currently active in the system, the number of non-acknowledged alarms and provides access to the historical alarm log.



When the database tree is not hidden this toolbar will be shown in horizontal, above the database tree.

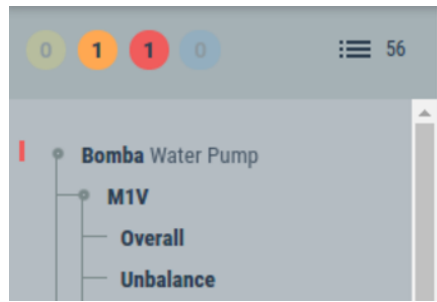

The active alarms are represented with circles, with a different color circle for each alarm level (from yellow to red for Warning, Alert and Danger).

Blue circle represents system errors. The number inside the circle represents the amount of currently active alarms for each type. Clicking on the circles will open a pop-up window that shows the list of active alarms of that type.

Clicking on the *Show all* button, the list will present all the active alarms in the system, no matter what their level.

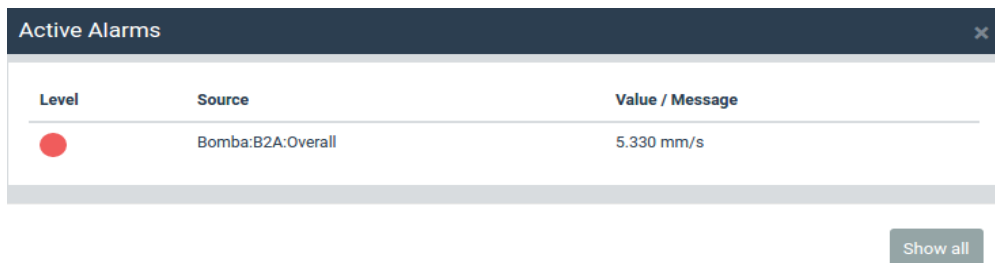

Besides the active alarm circles, the toolbar has this other icon:



This button will open the **Alarm log**, which is a list of all the historical alarms registered in the system. The number close to the icon indicates the number of alarms currently on that list. Clicking on the button will open the following panel:

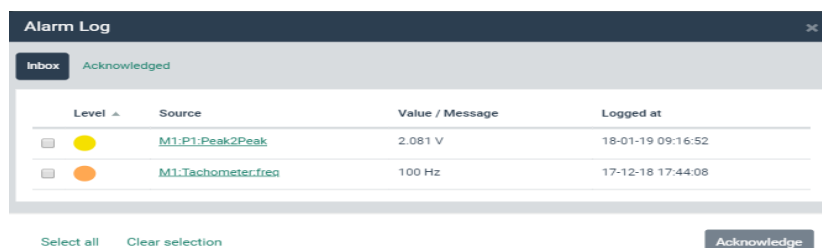

Field	Description
Level	Indicates the severity of the alarm. From yellow to red indicating warning, alert, and danger. Blue indicates <i>error</i>
Source	List of tags of the elements and sub-elements related to the alarm.
Value/Message	Shows the value of the parameter that raised the alarm/error.



Logged at	Date and time of the first appearance for that alarm/error.
-----------	---

By selecting the list items and clicking on “Acknowledge”, the corresponding alarms will be archived in a second list on this panel, of *Acknowledged* alarms. That should mean that a vibration analyst has reviewed the problem and made any corrective action.

This second list is remarkably similar to the one already described, but it also has additional fields to indicate by whom and when were the alarms acknowledged. Acknowledged alarms may also be permanently deleted.

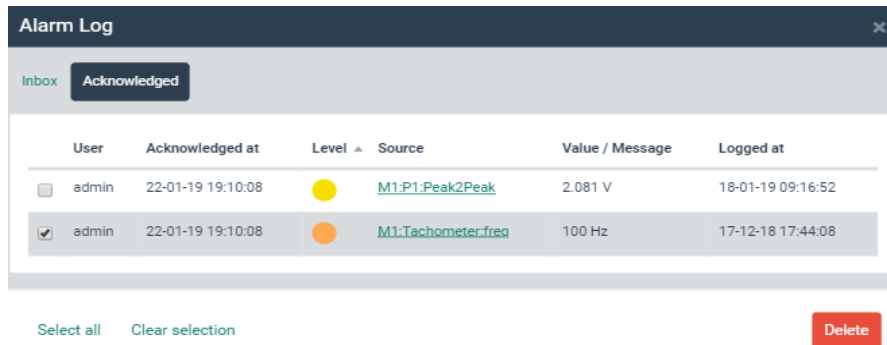

The screenshot shows a window titled "Alarm Log" with a sub-tab "Acknowledged". It contains a table with the following data:

	User	Acknowledged at	Level	Source	Value / Message	Logged at
<input type="checkbox"/>	admin	22-01-19 19:10:08	Yellow	<a href="#">M1:P1:Peak2Peak</a>	2.081 V	18-01-19 09:16:52
<input checked="" type="checkbox"/>	admin	22-01-19 19:10:08	Orange	<a href="#">M1:Tachometer.freq</a>	100 Hz	17-12-18 17:44:08

Below the table are buttons for "Select all", "Clear selection", and "Delete".



Alarms must be acknowledged in this menu in order to generate new [Notifications](#) if they happen again.

### 13.2.8. Configuration tree

The configuration tree is shown or hidden by clicking on the following button of the [Navigation bar](#):



This button will show or hide a tree structure on the left of the screen. Here in the Dashboard, this structure will show the measurement configuration of the system: all the machines, measuring points and parameters configured in the *Vigilant*.

If any of the *Parameters* is in any alarm mode, a vertical mark on the left of the tree will identify it with the corresponding color, as shown in the example below:

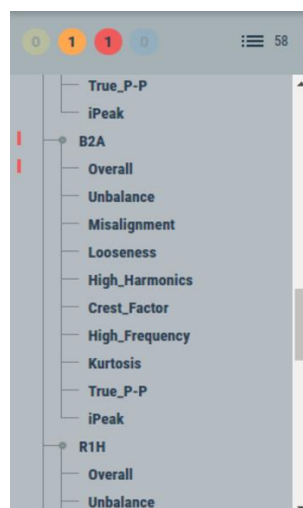

Clicking on any of the parameters will show up a window with the trend of that measurement and, on the other hand, clicking on the points will show their spectrum. This graph will have the normal functionality of the *Trend or Spectrum widgets*. Pressing ESC will close these windows.

### 13.2.9. Global play

At the bottom left of the Dashboard you will see the following icon:



The *Global Play* button will make the values of all the widgets to be updated automatically with the latest measurement performed by the *Vigilant*.

The *Play* state will last for a few minutes, and after that will go back to *Pause* mode after a while, in order not to waste data bandwidth.

### 13.2.10. Global timeline

At the bottom left of the Dashboard you will see the following icon:



This feature allows to synchronize the *Timeline* function found in many of the widgets described later. It allows setting a specific date and time to be applied simultaneously in all the *Widgets* visible on the active *Desktop*.

Pressing the button will show the date/time selection controls, at the bottom of the application:



<b>Field</b>	<b>Description</b>
Update	Apply the selected date and time to all the visible widgets in the desktop. They will go to the closest stored snapshot to the date and time selected.
Set to now	Selects the machine of the measurements to be shown from the pull-down list.

It is not even necessary to use this selection control. Once the Global Timeline function is enabled, just selecting one stored snapshot in the Timeline of any of the widgets, will do that all the other widgets go also to the same time moment.

With the widgets involving trend values (Trends, Phase Diagram, etc.), it happens something similar. In this case it is the cursor selection tools that will get synchronized. The cursors of these widgets will go to the Timeline selection made on other widgets, and in the opposite way, if the cursor on one of these widgets is moved, it will act as a time selection for the Timeline in the other widgets.



Applying a global Timeline will modify the date and time of all widgets that allow the functionality, regardless of whether the specific Timelines were active in the displayed widgets.

These features are especially useful to compare temporal data of several graphs simultaneously, without having to enter the date individually in each of them.

### 13.2.11. Keyboard shortcuts info

At the bottom of the Configuration Tree the interface shows the following button:



Clicking on it will show a pop-up window with all the **Keyboard Shortcuts** available for the different *Widgets*.

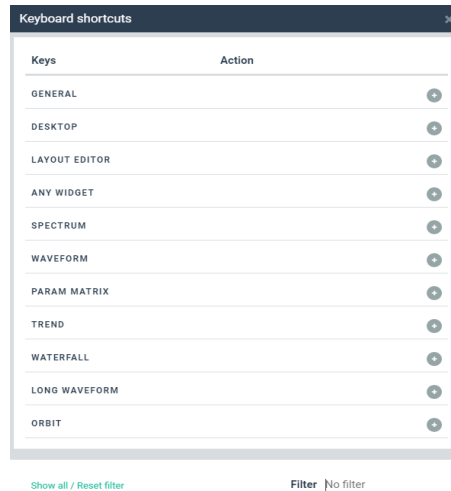

## 13.3. Widgets

This Chapter describes the different type of *Widgets*. It shows how to work with them and its configuration options. Widgets can be added by clicking on any blank space in any of the *Desktops* of the *Dashboard*:

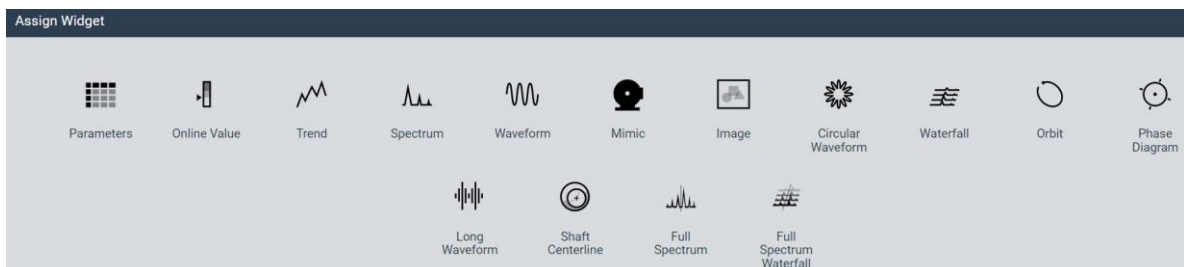

Some of the optional Widgets might be locked due to insufficient license.

The following table shows the different type of *Widgets* the user can currently create on the *Vigilant* units.

Widget type	Description
Spectrum/Full spectrum	Displays the spectrum of a particular measurement point and processing mode.
Waterfall/Full spectrum Waterfall	Displays the spectra waterfall (3D view) of a point.



Waveform	Displays the waveform of a particular measurement point.
Circular waveform	Displays a circular graph representing the waveform of a particular measurement point
Long Waveform	Displays a special long-time waveform of a particular point, which is a raw signal of up to several minutes long.
Orbit	Displays a two-dimensional graph of the space displacement of a rotating shaft, generated from the original waveforms. ( <a href="#">Optional software features</a> )
Trend	Presents the trend in time of a parameter or set of parameters.
Phase Diagram	Displays a Bode/Nyquist diagram generated from the peak-phase parameter calculated at one of the points. ( <a href="#">Optional software features</a> )
Parameters	Presents all the parameters measured for each point in a matrix format.
Online Value	Displays an indicator with the value of a parameter.
Mimic	Shows a mimic of the machine. Over the mimic the widget will show the measuring points of the machine, and their alarm status.
Image	Displays an image in any of the compatible formats (JPEG, PNG).
Shaft Centerline	Draws a two-dimensional graph with the average radial position of the shaft. ( <a href="#">Optional software features</a> )

### 13.3.1. Widget Toolbar

All the *Widgets* have a Window Toolbar at the top. This Toolbar shows the name of *Widget* or the *Machine, Point and Processing Mode* or *Parameter* in case the name is left blank at its configuration. On the right it shows the Window buttons: *Configuration, Remove* and *Maximize*.



The following table describes these options:

Symbol	Description
	Shows the configuration form of the <i>Widget</i> in a pop-up window.
	Removes the <i>Widget</i> from the Desktop. A pop-up window will appear in order to confirm the action.
	Maximizes the <i>Widget</i> size. Click again in this button or outside the <i>Widget</i> , or press ESC key, in order to go back to its normal size.

### 13.3.2. Timeline

The *Timeline* is a graphical tool that allows the user to access quickly to the measurements stored on the database of the *Vigilant* module. Clicking on this button:



the *Widget* will show up the *Timeline* at the bottom part of the *Widget*.



Each bar of the *Timeline* represents a stored measurement, which is allocated on a temporal line depending on the date and time the measurement was taken. This temporal line can be zoomed in and out. It can also be moved by clicking and dragging to the left and right with the mouse.

The color of each bar shows the alarm condition of the machine when the measurement was taken, which in turn is defined as the worst alarm condition of any of the measurements performed at that date/time. The color allows the user to quickly identify those times at which the machine was in alarm condition or not.

### Single snapshot Timeline

In some widgets, like *Spectrum*, *Waveform*, *Parameter Matrix* or *Orbit*, the timeline just allows selecting one of the stored snapshots, and the widget will show the data corresponding to that date and time. The following picture shows the *Timeline* on the *Spectrum Widget*:

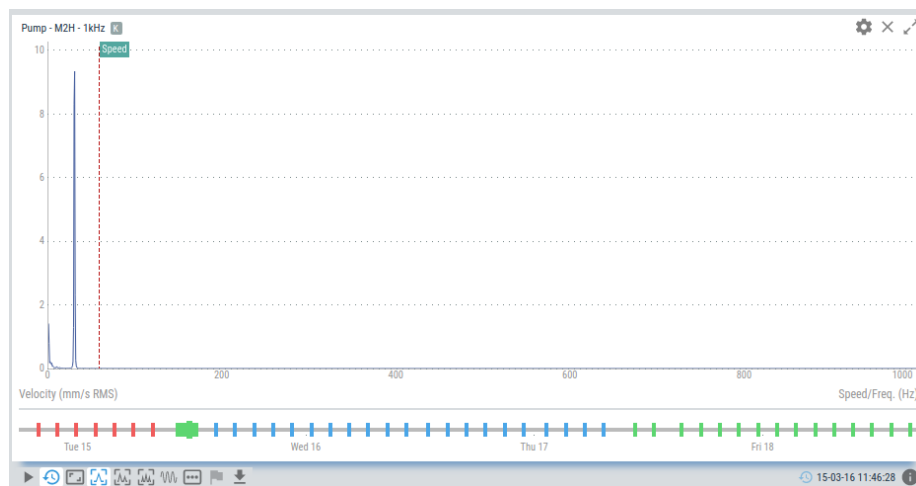

### Range selection timeline

In some other widgets, like the *Waterfall*, the *Phase Diagram*, or the *Shaft Centerline* behaves a little bit different, as it actually allows selecting a range of *Snapshots* to be represented in the chart (not just one):

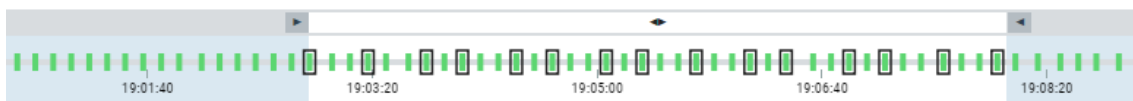

Each vertical bar on the *Timeline* represents a stored measurement, including a specific date and time and a color representing its alarm state, like in all the other *Timelines*. This temporal line may also be zoomed in and out. It can also be moved by clicking and dragging to the left and right with the mouse.

The main difference is that, with the help of the mouse, clicking and dragging the area selector above the timeline, it is possible to select the range of dates from which the data will be displayed.

In the case of the *Waterfall*, some black marks indicate which captures of the *Timeline* are being effectively represented, since depending on the configuration of the widget not all the spectra will be drawn (See option “number of spectra” in the configuration of this widget). The marks will be distributed in a balanced way among all the available captures in the selected range, and those will be the spectra to be drawn.

### 13.3.3. Zoom usage

Several *Widgets* have the possibility to zoom in and out of the graphs by using the mouse wheel. The default zoom, by placing the cursor over the widget, is the horizontal zoom. The vertical zoom is performed by placing the cursor over the Y-axis of the graphs.

Since firmware version 0.12, User can drag and drop contents with the left mouse button, while holding down the SHIFT key, to zoom the graphs in a specific zone. The default zoom is horizontal. Combining the SHIFT+ALT key forces vertical zoom, while SHIFT+ALT+CTRL forces a free rectangular zoom.

The keyboard shortcut **z** allows you to reset the zoom level to the default values

### 13.3.4. Filtering by Alarm or State

Several *Widgets* have the possibility to filter the stored data, only showing records corresponding to the machine in a given state, or a specific alarm status. This can be done by clicking on the following icon:



The selection of the active states or alarms will be done in an emerging selection panel, like the following:

- Alarm: None
- Alarm: Alert
- Alarm: Warning
- Alarm: Danger
- State: Default
- State: Measuring



The alarm levels of the recorded data are calculated according to the settings when the data was stored. Those levels may have changed since then, and the interface may be showing incorrect alarm levels to those points, especially in the Trends widget.

### 13.3.5. Dynamic cursor

Those *Widgets* representing a graphical plot (Spectrum, Waveform, Trend, Orbit) will show a dynamic cursor when moving the mouse over the graph. This cursor is represented with a red spot and is located on the point of the plot vertically aligned with the mouse position. The following example shows this dynamic cursor over a waveform.

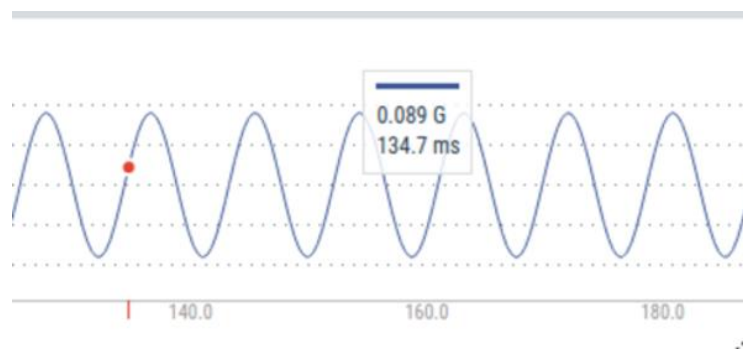

When the mouse location is close to the dynamic cursor a pop-up window will appear at the top-center of the *Widget*, showing the X and Y values of the cursor and its units. For multiple trends, the *Widget* will present several windows, one for each trend, as shown below.

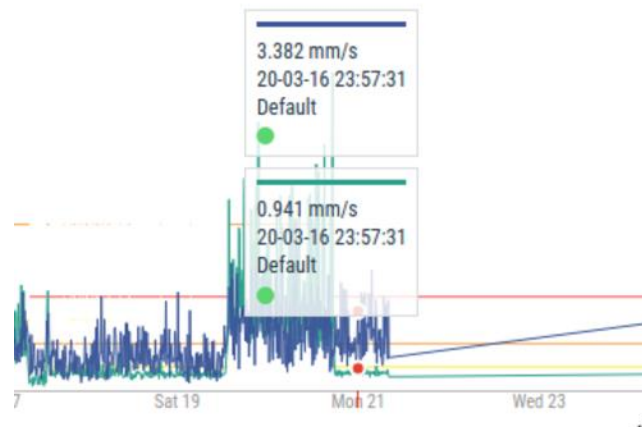

### 13.4. Parameter Matrix

This *Widget* displays in a matrix format all the parameters measured for each dynamic point of the machine. The *Widget* allows the user to see in a single view the current condition of a machine, with all the latest measurements and its alarms. Historical values can also be accessed through its *timeline* bar.

#### 13.4.1. Configuration

The following picture shows its configuration settings, which may be accessed through the shortcut key “c” or the button in the right corner.

<b>Field</b>	<b>Description</b>
Name	Defines the name to the <i>Widget</i> . It will be shown at the upper bar of the <i>Widget</i> .
Machine	Selects the machine of the spectrum from the pull-down list.
Layout	Selects the type of layout, either horizontal or vertical, for the parameter matrix. This defines where the static parameters will be shown, either on the right (horizontal) or below (vertical) of the main matrix.
Text size	Selects the size for the text within the cells of the matrix. This can help to adapt the matrix size to the available space on the desktop window. There are 4 size options: Extra small, Small, Medium and Large

Show units	Shows or hides units and detectors of the different parameters of the matrix.
Show bias	Show a new row at the top of the matrix with all the DC values of the input channels associated to each dynamic point.

### 13.4.2. Display

The following picture shows the Parameter Matrix and its components.

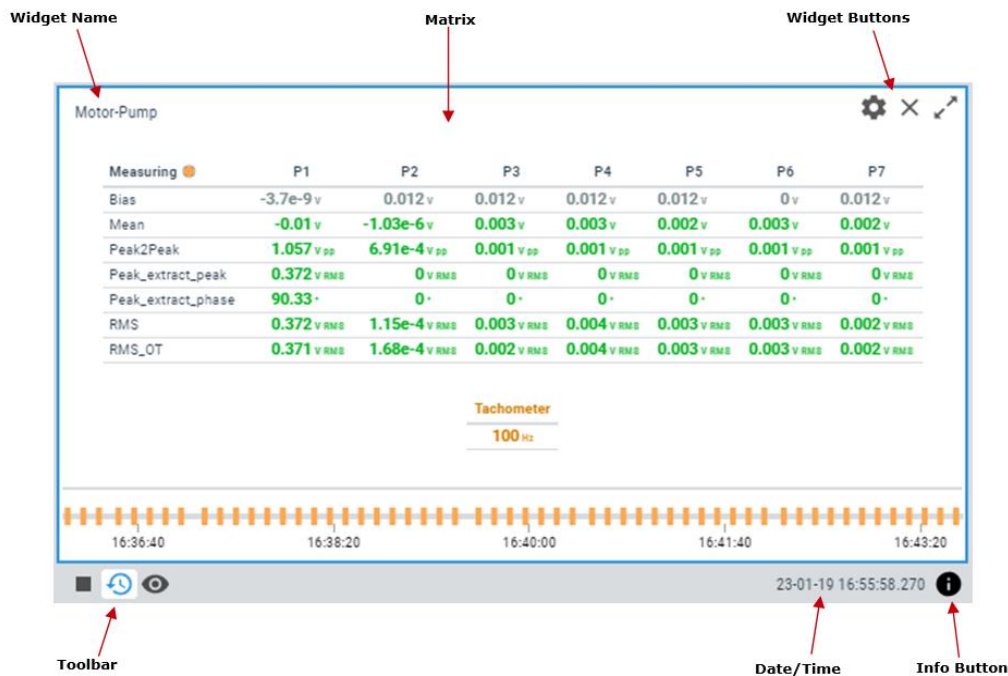

Symbol	Description
	The <i>Play/Pause</i> button will make the values of the parameter matrix to be updated automatically with the latest measurement performed by the <i>Vigilant</i> .
	<i>Pause</i> button will freeze the current values, so the parameter matrix will not be updated with new measurements.
	Shows the <i>Timeline</i> of the parameter matrix measurements. The <i>Timeline</i> presents in a graphical mode the array of measurement. The different captures are ordered by its date/time on the <i>Timeline</i> and are represented as a vertical bar. The color of the bar represents the machine alarm status at that date. Clicking on any of these bars will update the matrix with the parameter measurements for that particular date. See <i>Timeline</i> for more information.
	<i>Timeline Filter</i> button will hide the marks in the timeline that do not match the selected Machine State or Alarm status. Those records will be displayed more diffused in the timeline and it will not be possible to select them.
	Shows/hides the parameter matrix information box. This box shows the following information associated with the matrix: machine name, speed, load, state and alarm condition of the machine at the time selected.

### 13.4.3. Cell Colors

The cell's background colors will be in yellow, orange, or red in case the corresponding parameter reaches the alarm condition Warning, Alert or Danger, respectively. In case the parameter goes above



the validation range defined on the configuration of the measurement the cell background will change into blue color.

On the other hand, the background of the dynamic point cell will get the color of the worst alarm condition of any of its associated parameters. In case the validation range of the sensor is out of limits, as defined on its configuration, the dynamic cell point will get a blue background color.

#### 13.4.4. Graph access

By clicking on any of the cells the interface will show a pop-up window with the trend of the parameter selected. This window can be closed by selecting the corresponding button of the window or by pressing the ESC key.

Mouse clicking on the dynamic point cells the interface will present all the *Processing modes* in a list, as shown below.

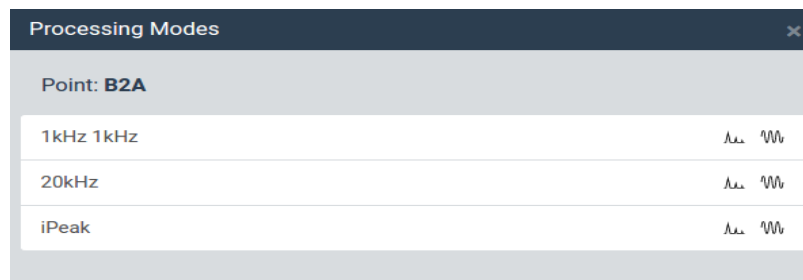

The symbols on the right of every row show the corresponding Processing Mode has associated Spectra or Waveforms. If the symbols are painted in black, the graph will exist, but it will not if the symbol is colored in gray.

Selecting one of the *Processing modes* a window will show up with the corresponding spectrum measurement. This spectrum window will have the same functionality as the normal spectrum *Widget*. For instance, the associated waveform could be visualized by clicking on the corresponding icon from the window toolbox. In any case, the pop-up window can be closed by pressing the ESC key.

### 13.5. Online Value

This *Widget* displays the online value of a parameter measure on a dynamic input of the *Vigilant*.

#### 13.5.1. Configuration

The following picture shows its configuration settings. Once the *Widget* is selected click on the shortcut key "c" or the button to show its configuration form.

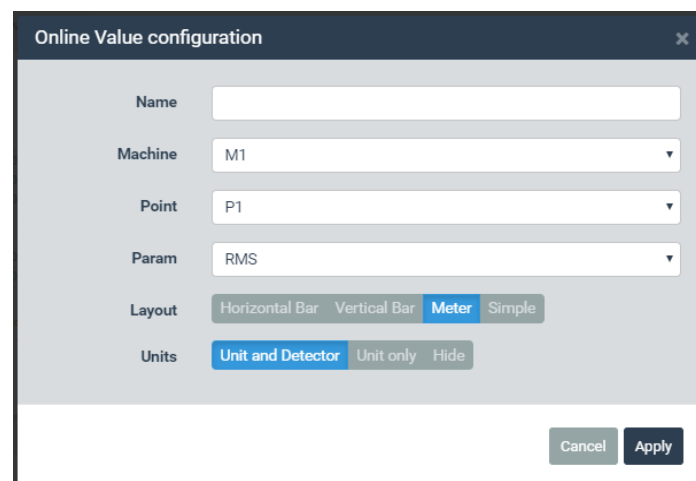

<b>Field</b>	<b>Description</b>
Name	Defines the name to the <i>Widget</i> . It will be shown at its upper bar.
Machine	Selects the machine of the measurements to be shown from the pull-down list.
Point	Selects the point of the measurement for that source from the pull-down list.
Param	Selects the parameter or measurement to be plotted for that source from the pull-down list.
Layout	Changes the way the <i>Widget</i> will present the information. <i>Simple</i> mode will just present the value of the selected measurement, along with its units and detector. <i>Horizontal Bar</i> and <i>Vertical Bar</i> mode will show a bar in horizontal or vertical direction respectively. <i>Meter</i> mode will show a “gauge” type of view of the value.
Units	Displays or hides magnitude units (e.g. mm/s) and applicable detectors (e.g. RMS) for the parameter.

### 13.5.2. Display

The following picture shows the *Online Value Widget* and its components.

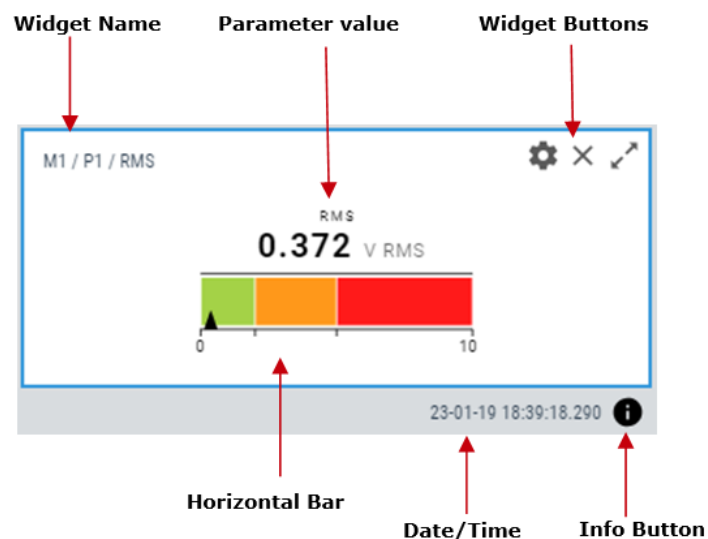

<b>Symbol</b>	<b>Description</b>
	Shows/hides the global value information box. This box shows the following information associated with the measurement: machine name and speed.

### 13.5.3. Types of graphs

The *Online Value Widget* may be configured to display the data in 4 different chart types: Simple, Horizontal bar, Vertical bar, and Meter.

The Simple type will only display the magnitude, with optional unit and detector, and a small color circle with the given value's alarm status. In the other three cases, the measurement value will be represented by an arrow and a meter, which also displays the different zones corresponding to the different alarm levels configured to the parameters. Thus, it is easy to see how far away the value from the different alarm levels is.

In the following chart it is shown the different kind of meter types available for the *Online Value Widget*:

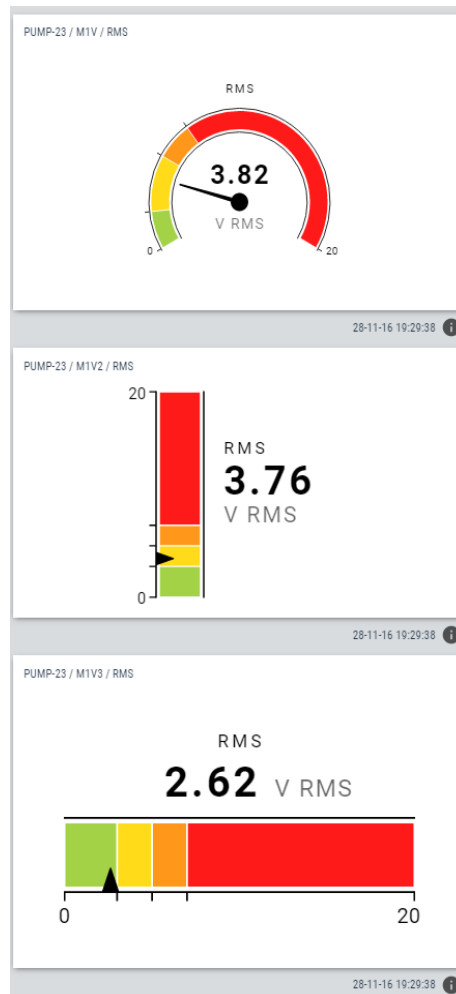

#### 13.5.4. Access to trends chart

By clicking on the measurement value, the interface will present a window with the trend of the parameter. The graph will have all the options as the trend *Widget*. This window can be closed by selecting the corresponding button of the window or by pressing the ESC key.

### 13.6. Trends

This *Widget* displays a chart of the evolution in time of one or several parameters.

#### 13.6.1. Configuration

The following picture shows its configuration settings. Once the *Widget* is selected click on the button on the top right corner of the widget or use shortcut key "c" to display its configuration form.

The screenshot shows the 'Trend configuration' dialog box with the following settings:

- Name:** (Empty text field)
- Machine:** M1 (Dropdown menu)
- SOURCE 1:** Red
- SOURCE 2:** Yellow
- SOURCE 3:** Green
- SOURCE 4:** Blue
- Y AXIS:** (Empty text field)
- DATA:** (Empty text field)
- Line Color:** (Color selection icons)
- Point:** P2 (Dropdown menu)
- Param:** RMS (Dropdown menu)
- Buttons:** Cancel, Apply

<b>Field</b>	<b>Description</b>
Name	Defines the name to the <i>Widget</i> . It will be shown at its upper bar.
Machine	Selects the machine of the measurements to be shown from the pull-down list.
Source [1..4]	From these tabs up to 4 data source or measurements can be selected to be plotted on the <i>Widget</i> .
Line Color	Selects the color of the trend line for the particular data source or measurement.
Point	Selects the point of the measurement for that source from the pull-down list.
Param	Selects the parameter or measurement to be plotted for that source from the pull-down list.
View mode	Define how the graph points for the selected parameter will be displayed: as a continuous line ( <i>Default</i> ) or as separated, unconnected points ( <i>Scatter</i> )

<b>Field</b>	<b>Description</b>
Domain	Sets the maximum and minimum values visible in the Y axis. Note that clicking on the <i>Reset zoom</i> button with this the <i>Custom</i> option enabled will reset it to the values set in this form.



<b>Field</b>	<b>Description</b>
Show Alarms	Displays horizontal lines on the graph indicating alarm levels corresponding to the parameter that has the focus.
Show States	Displays a shadowed background and with information about the state of the machine at each period.
Horizontal Lines	Shows or hides horizontal grid lines on the <i>Widget</i> .
Vertical Lines	Shows or hides vertical grid lines on the <i>Widget</i> .

### 13.6.2. Display

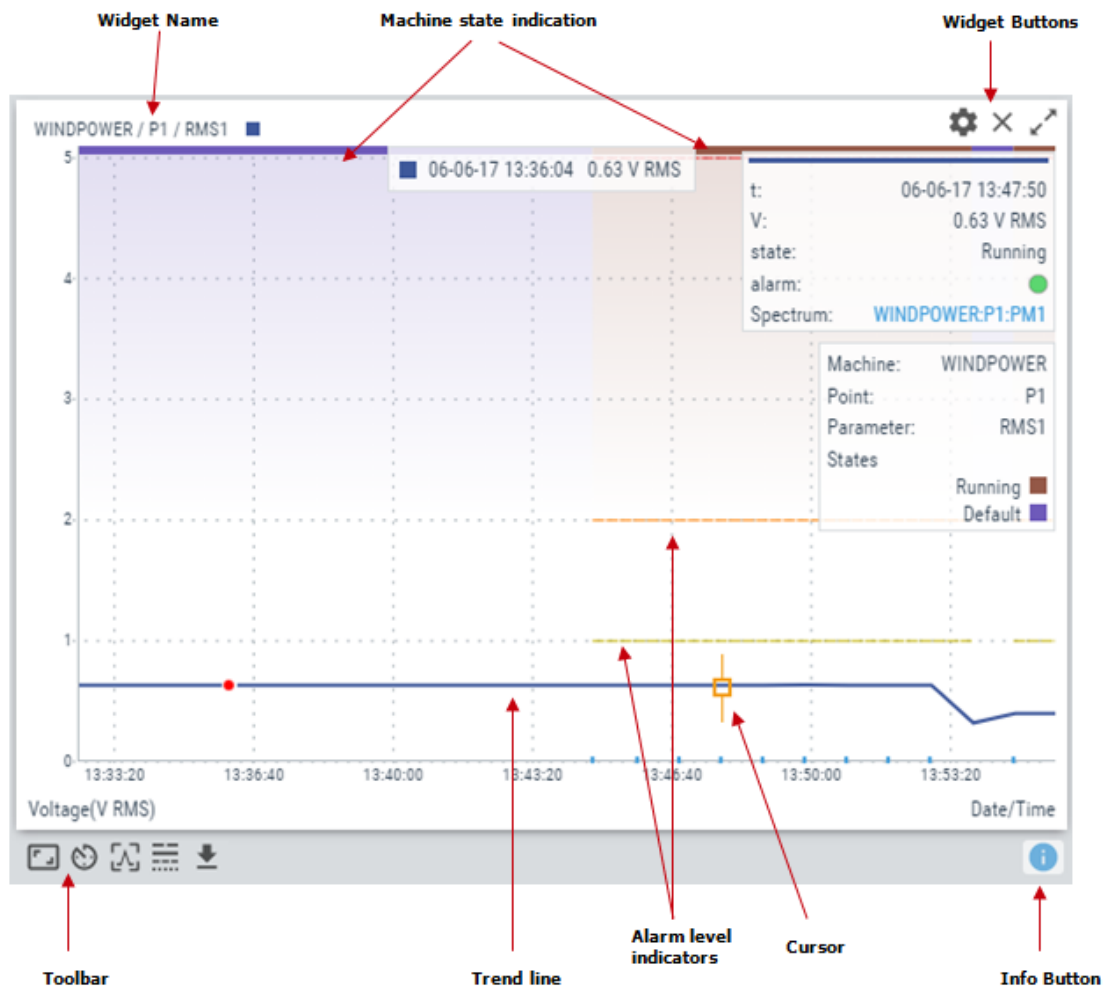
The following picture shows the trend *Widget* and its components.



Symbol	Description
	Sets the current range of the trend from the pull-down list. The time range available are <i>1 hour, 12 hours, 1 day, 3 days, 1 week, 1 month, 3 months, 9 months, 1 year.</i>
	Trends <i>Filter</i> behaves similar as the timeline filter in other widgets. The button allows selecting which machine state and alarm status to show, and the rest of the points will get hidden. Note that the points' alarm status is calculated when the data was stored and may not match with actual settings.
	Restores the zoom to its normal condition, removing the effect of any previous zoom done on the plot.
	Sets the current cursor as a single cursor type. Clicking with the mouse on the graph will add a cursor to the trend plot.
	Selects the trend that will get the focus on the plot. make the cursor to locate on the corresponding trend.

	Exports the trend values to CSV format and creates and downloads it into a local file.
	Shows/hides trend information box. This box shows the following information associated with each trend: machine, point and parameter, along with the color line for each of them.

Note that the colored background of the graph is used to show information about the different machine states along time (when this option is activated in the configuration of the widget). The relation in between states and background colors is shown in the info panel of the widget:

```

Machine:  WINDPOWER
Point:    P1
Parameter: RMS1
States
Running  ■
Default  ■

```

### 13.6.3. Zoom tools

Use the mouse wheel to zoom in and out horizontally on the trend plot. The *Widget* will zoom the trend around the time aligned vertically with the mouse location. After zooming, you can use drag and drop with the left button of your mouse to move the plot left and right.

To make a zoom in a vertical direction locate the mouse over the Y axis and use the mouse wheel. The trend plot will vertically zoom in and out from the location of the mouse. Locate the mouse aligned with the 0 value of the scale to zoom in and out keeping that reference still.

Click on the *Reset zoom* button:



to restore the plot to its normal scaling, removing the effect of any previous zoom done on the plot.

### 13.6.4. Time range

Clicking on the *adjust time-domain* icon.



will allow you to select the default time range that will be shown in the Trend widget, which ranges from 1 hour to 1 year of data in several steps.

### 13.6.5. Single cursor

Clicking on any part of the graph will add a *Single* type cursor to the trend plot, even if that tool was not yet selected in the main toolbar:



Clicking on this icon will show a pop-up window at the top right side of the *Widget* with some information about the point selected by the user:

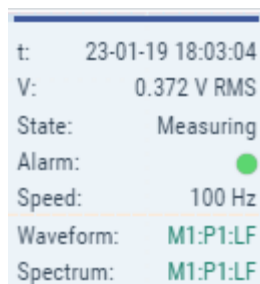

- Date and time when the point was measured.
- Value of the signal in that moment.
- State of the machine to which the parameter belongs.
- Alarm status of that machine.
- Speed of the machine.
- Waveform: a quick link to see the waveform related with the parameter (if available).
- Spectrum: a quick link to see the spectrum related with the parameter (if available).

Once the cursor is created clicking on the graph again will move the cursor into that point of the trend vertically aligned with the mouse click position. The cursor can also be moved by pressing on left and right arrows of the keyboard, jumping from line to line of the spectrum. Keys “a” and “s” will move the cursor to the left and right respectively in smaller steps (a tenth of the spectrum resolution).

## 13.7. Spectrum

This *Widget* displays the spectrum measurement of a dynamic point.

### 13.7.1. Configuration

The following picture shows its configuration settings. Once the *Widget* is selected click on the shortcut key “c” or the button to display its configuration form.

Field	Description
Name	Defines the name to the <i>Widget</i> . It will be shown at the upper bar of the <i>Widget</i> .

Color	Selects the color of the spectrum line.
Machine	Selects the machine of the spectrum from the pull-down list.
Point	Selects the dynamic point of the spectrum from the pull-down list.
Proc. Mode	Selects the <i>Processing mode</i> of the spectrum from the pull-down list.

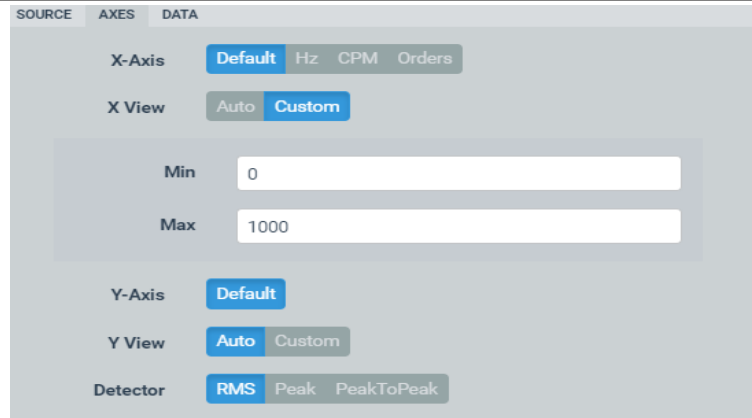

Field	Description
X-Axis	Sets the frequency units of the spectrum. Select between <i>Default</i> , <i>CPM</i> , <i>Hz</i> or <i>Orders</i> . <i>Default</i> will use the units defined on the <i>User Preferences</i> .
X View	Sets the maximum and minimum values visible in the X axis. Note that clicking on the <i>Reset zoom</i> button with this option enabled will reset it to the values set in this form.
Y-Axis	Shows the property of the Y axis. For vibration sensors this field selects between <i>Default</i> , <i>Acceleration</i> , <i>Velocity</i> or <i>Displacement</i> . <i>Default</i> will set the property to the one defined on the <i>Machine-Point-Processing Mode</i> in the <i>main Configuration</i> .
Y View	Sets the maximum and minimum values visible in the Y axis. Note that clicking on the <i>Reset zoom</i> button with this option enabled resets it to the values set in this form.
Detector	Selects the detector to be applied to the spectrum amplitude (RMS, Peak, Peak-Peak).

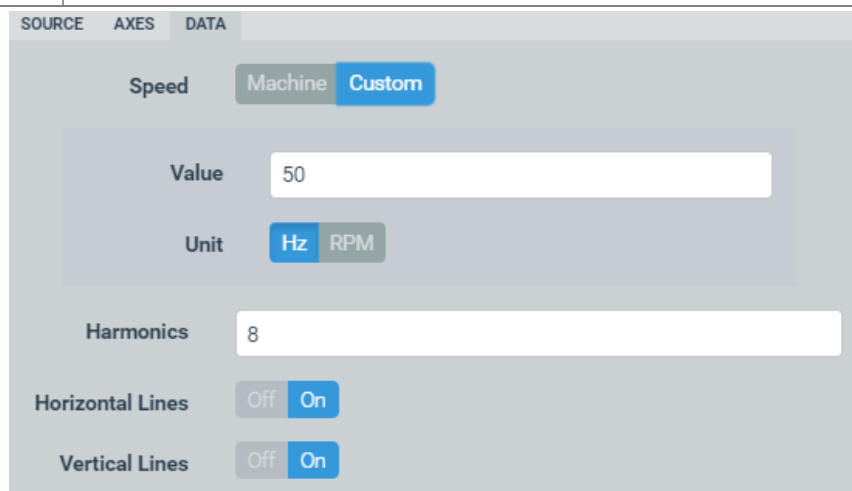



Field	Description
Speed	Configure the widget to use the <i>Machine speed</i> depending on the configuration, or to use a custom user setting. This affects how the cursors behave.
Harmonics	Sets the number of harmonics the <i>Harmonic</i> and <i>Side Band</i> cursor will show.
Horizontal Lines	Shows or hides horizontal grid lines on the <i>Widget</i> .
Vertical Lines	Shows or hides vertical grid lines on the <i>Widget</i> .







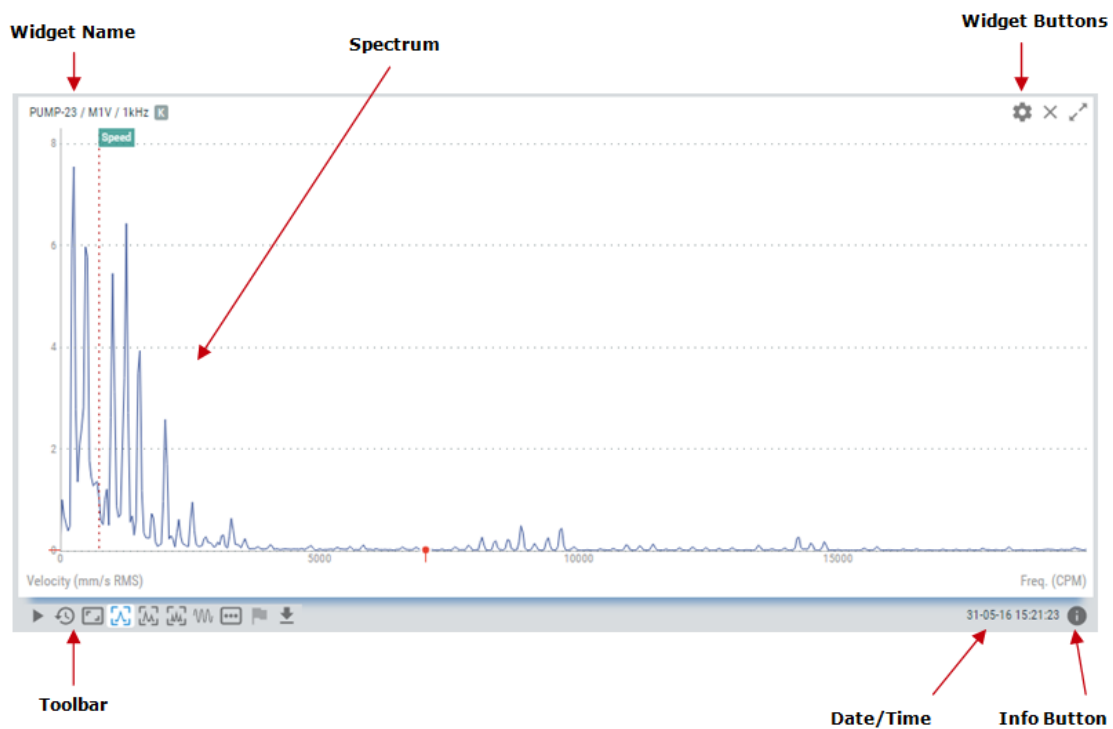





### 13.7.2. Display

The following picture shows the spectrum *Widget* and its components.



Symbol	Description
	The <i>Play/Pause</i> button will make the values of the spectrum to be updated automatically with the latest measurement performed by the <i>Vigilant</i> . The <i>Play</i> state will last for a few minutes and will go back to <i>Pause</i> mode after a while, in order not to waste data bandwidth.
	<i>Pause</i> button will freeze the current spectrum, so the plot will not be updated with new measurements.

	Shows the <i>Timeline</i> of the spectrum measurements. The <i>Timeline</i> presents in a graphical mode the array of spectra stored on this point for the selected <i>Processing mode</i> . The spectra are ordered by its date/time on the <i>Timeline</i> and are represented as a vertical bar. The color of the bar represents the machine alarm status at that date. Clicking on any of these bars will update the plot with the spectrum for that date. See <i>Timeline</i> more information.
	<i>Timeline Filter</i> button will hide the marks in the timeline that do not match the selected Machine State or Alarm status. Those records will be displayed more diffused in the timeline, and it will not be possible to select them.
	Restores the zoom to its normal condition, removing the effect of any previous zoom done on the plot.
	Sets the current cursor as a single cursor type.
	Sets the current cursor as a harmonic type cursor. This will show the main frequency selected and the number of harmonics defined on the configuration of the <i>Widget</i> .
	Sets the current cursor as a side band type cursor. This will show a center frequency and sidebands around it, each of them with the number of harmonics defined on the configuration of the <i>Widget</i> .
	Shows the waveform measured along with the spectrum, as defined in the configuration of the corresponding <i>Processing Mode</i> .
	Selects the <i>Processing mode</i> the <i>Widget</i> will show the spectrum from.
	Shows the list of <i>Fault Frequencies</i> defined for the corresponding dynamic point. Selecting one of them will show on the spectrum plot the <i>Fault Frequency</i> as a dotted red line, along with the harmonics defined on its configuration.
	Exports the spectrum values to CSV format and creates and downloads it into a local file.
	Shows/hides spectrum information box. This box shows the following information associated with the measurement: machine, dynamic point, processing mode, machine speed and load, sensor bias voltage, machine state and alarm condition, maximum and minimum frequency of the spectrum.

### 13.7.3. Zoom

Use the mouse wheel to zoom in and out horizontally on the spectrum plot. The *Widget* will zoom the spectrum around the frequency aligned vertically with the mouse location. After zooming-in use drag and drop with your mouse to move the plot left and right.

To make a zoom on vertical direction, locate the mouse over the Y axis and use the mouse wheel. The spectrum plot will vertically zoom in and out.

Click on the *Reset zoom* button to restore the plot to its normal scaling, removing the effect of any previous zoom done on the plot.



### 13.7.4. Fault Frequencies

This option shows on the spectrum plot the fault frequencies assigned to the measurement point. Fault frequencies are those related to different failure modes on the machine (gear mesh, ball bearing, RPM harmonics, belts, etc.). These frequencies are defined on the configuration of the system and can be assigned to the different dynamic points.

By clicking on the icon:



the Widget will show the list of *Fault Frequencies*.

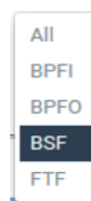

By selecting one of them, the corresponding *Fault Frequency* will be represented on the spectrum as a dotted vertical line, along with its harmonics. The number of harmonic lines is defined on the configuration of the *Fault Frequency*.

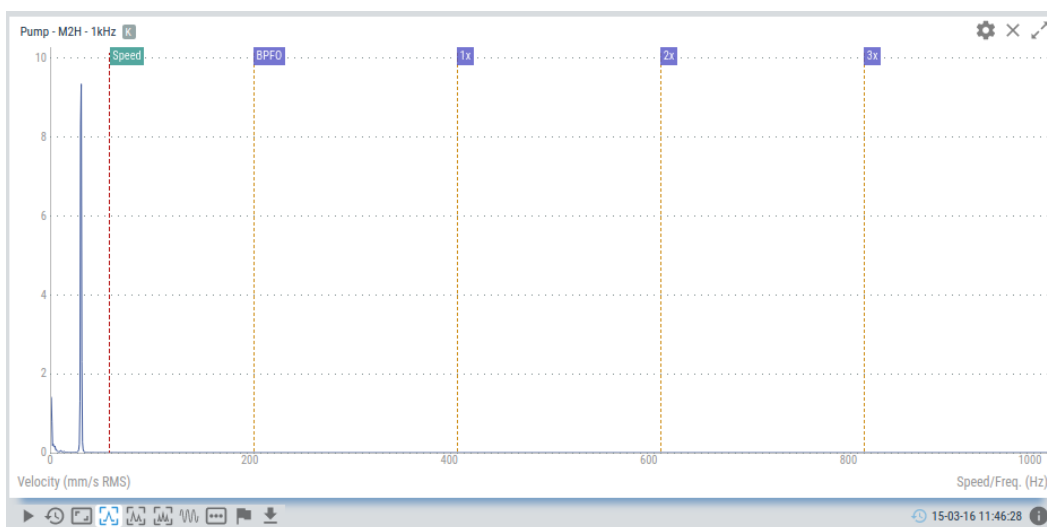

### 13.7.5. Cursors

Cursors allow the user to mark any frequency of the spectrum. The *Widget* provides 3 different types of cursors: *Single*, *Harmonic* and *Side Band*.

#### Single cursor

After selecting then placing the *Single* cursor icon on the graph:



The cursor can be moved by using the left and right arrows of the keyboard. Keys “a” and “s” will move the cursor to the left and right respectively in smaller steps (a tenth of the spectrum resolution). On the other hand, by pressing the upwards arrow of the keyboard the *Widget* calculates the amplitude and frequency with more accuracy using mathematical methods.

By selecting this cursor, the *Widget* will present a window at the top right side, with the amplitude and frequency values where the cursor is located. The *Set as speed* button sets the speed of the spectrum as the frequency selected by the cursor.

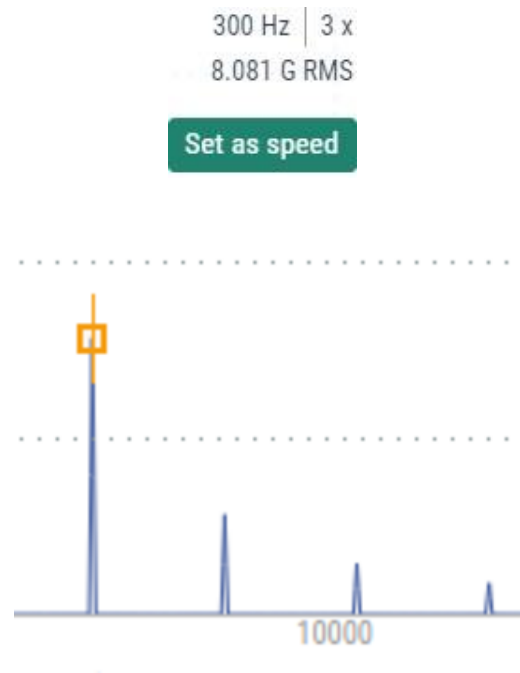

### Harmonic cursor

After selecting the *Harmonic* cursor icon clicking on the graph will add Harmonic type cursors to the spectrum. This cursor type will show the main frequency selected and the number of harmonics defined on the configuration of the *Widget*.



The main cursor can be moved by using the left and right arrows of the keyboard. The main cursor is identified by a vertical line crossing the cursor itself. Keys “a” and “s” will move the cursor to the left and right respectively in smaller steps (a tenth of the spectrum resolution).

On the other hand, by pressing the upwards arrow of the keyboard, the *Widget* calculates the amplitude and frequency with more accuracy using mathematical methods.

By selecting this cursor, the *Widget* will present a window at the top right side, with the amplitude and frequency values where both cursors are located. The *Show all points* button presents the list of all harmonic cursors.

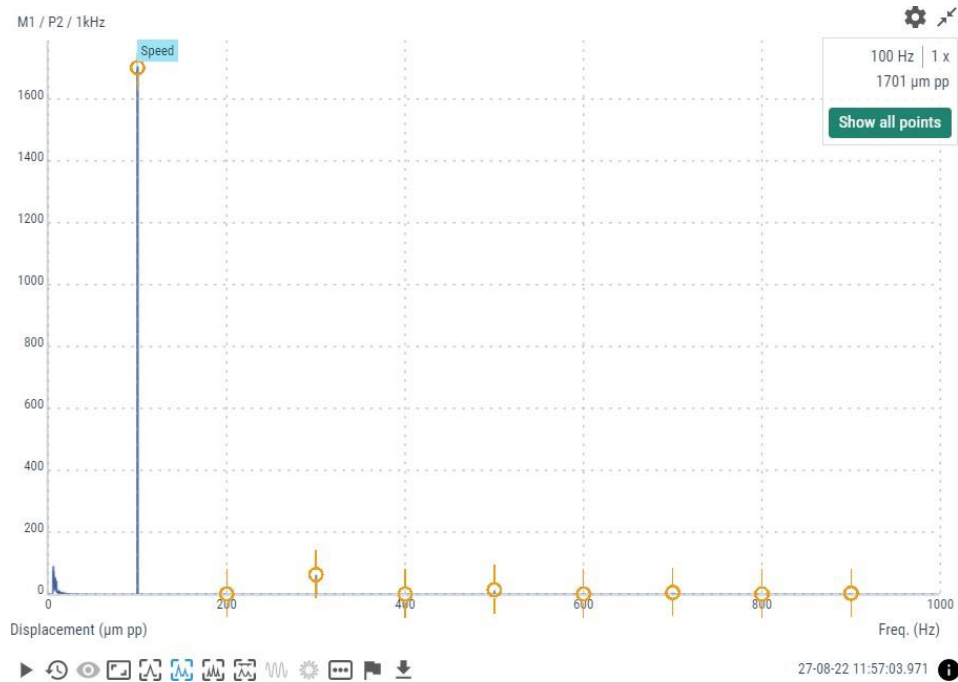

### Side band cursor

The *side band* cursor will show on the spectrum a center frequency and sidebands around it, each of them with the number of harmonics defined on the configuration of the *Widget*.



Once the cursor is on the correct frequency peak, clicking again on the graph will set this frequency as the central one, which will be identified with a red vertical line, and add the side band cursor and its harmonics. Sideband cursor can also be moved using the left and right arrows of the keyboard, which will also move the corresponding sidebands harmonics.

When selecting this cursor, the *Widget* will present a window at the top right side with the amplitude and frequency values where the main cursor is located, plus the frequency difference between the main cursor and the first sideband. The *Show all points* button presents the list of all sideband cursors.

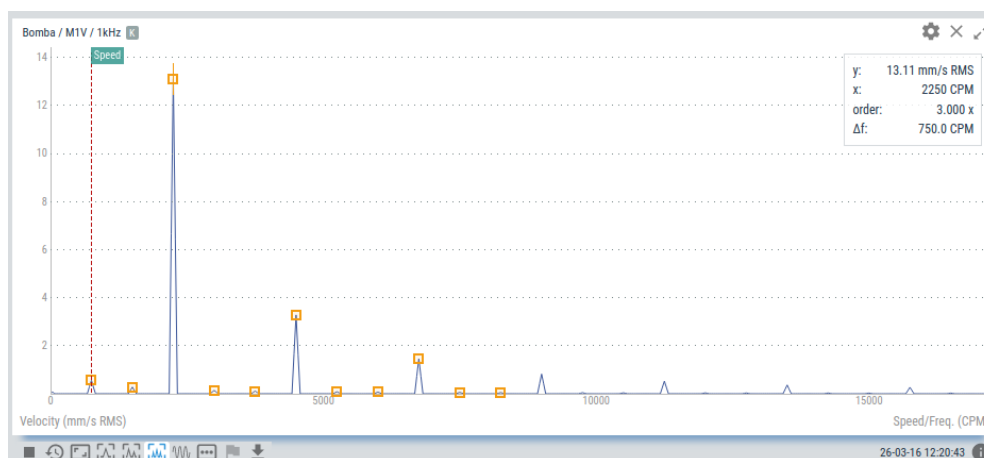

## 13.8. Waveform

This *Widget* displays the waveform measurement of a dynamic point.

### 13.8.1. Configuration

The following picture shows its configuration settings. Once the *Widget* is selected click on the shortcut key “c” or the button to display its configuration form.

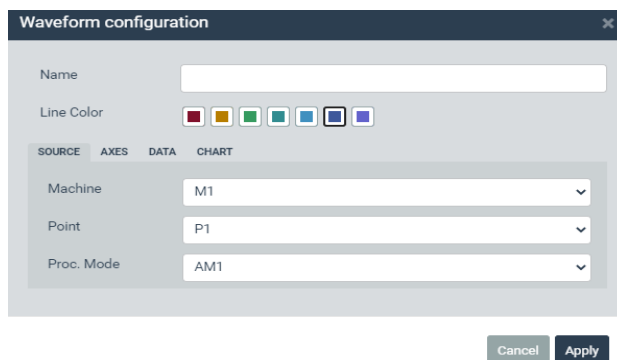

Field	Description
Name	Defines the name to the <i>Widget</i> . It will be shown at the upper bar of the <i>Widget</i> .
Line Color	Selects the color of the waveform line.
Machine	Selects the machine of the waveform from the pull-down list.
Point	Selects the dynamic point of the waveform from the pull-down list.
Proc. Mode	Selects the <i>Processing mode</i> of the waveform from the pull-down list.

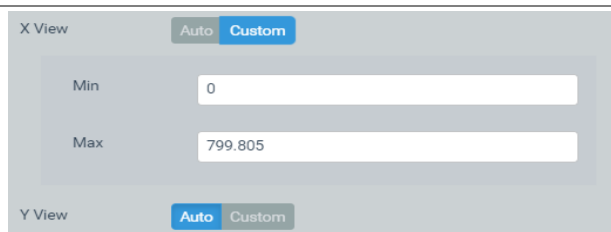

Field	Description
X View	Sets the maximum and minimum values visible in the X axis. They can be manually defined by the user, or just let the graph adjust to the data when Auto option is enabled. Note that clicking on the <i>Reset zoom</i> button with this option enabled will reset it to the values set in this form, if Custom setting is selected
Y View	Sets the maximum and minimum values visible in the Y axis. They can be manually defined by the user, or just let the graph adjust to the data when Auto option is enabled. Note that clicking on the <i>Reset zoom</i> button with this option enabled will reset it to the values set in this form, if Custom setting is selected.

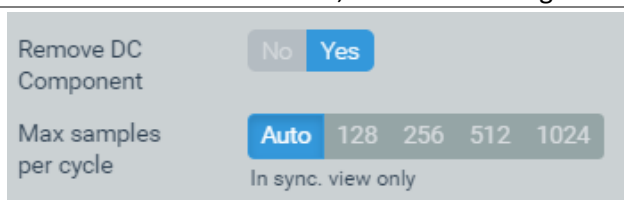

Field	Description
Remove DC Component	Subtract mean value (DC component) from waveform points.
Max samples per cycle	Selects the maximum number of sample points to show per machine rotating cycle (in between two tachometer edges) when some type of Synchronous View is selected.

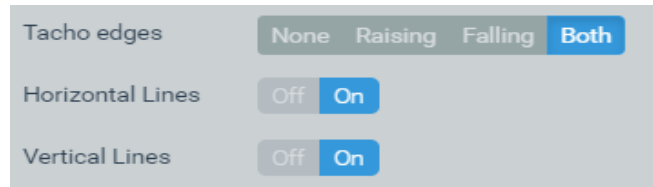







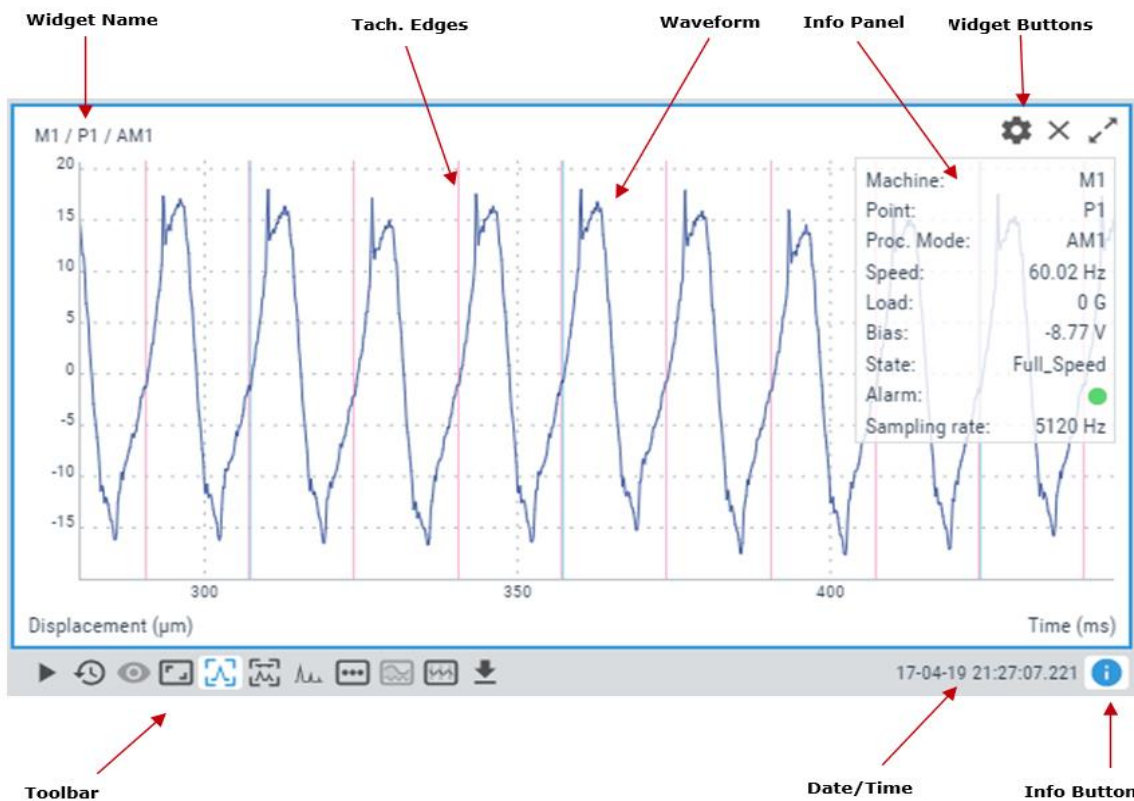



Field	Description
Tacho edges	Shows or hides vertical marks on the <i>Widget</i> indicating the position of the tachometer edges. The <i>Machine</i> needs to have a <i>Tachometer point</i> connected to a <i>Pulse train</i> input.
Horizontal Lines	Shows or hides horizontal grid lines on the <i>Widget</i> .
Vertical Lines	Shows or hides vertical grid lines on the <i>Widget</i> .



### 13.8.2. Display

The following picture shows the Waveform *Widget* and its components.



<b>Symbol</b>	<b>Description</b>
	The <i>Play/Pause</i> button will make the values of the waveform to be updated automatically with the latest measurement performed by the <i>Vigilant</i> . The <i>Play</i> state will last for a few minutes and will go back to <i>Pause</i> mode after a while, in order not to waste data bandwidth.
	Shows the <i>Timeline</i> of the waveform measurements. The <i>Timeline</i> presents in a graphical mode the array of waveforms stored on this point for the selected <i>Processing mode</i> . The waveforms are ordered by its date/time on the <i>Timeline</i> and are represented as a vertical bar. The color of the bar represents the machine alarm status at that date. Clicking on any of these bars will update the plot with the waveform for that date.
	<i>Timeline Filter</i> button will hide the marks in the timeline that do not match to the selected Machine State or Alarm status. Those records will be displayed more diffused in the timeline, and it will not be possible to select them.
	Restores the zoom to its normal condition, removing the effect of any previous zoom done on the plot.
	Sets the current cursor as a single cursor type.
	Sets the current cursor to <i>Delta Time</i> cursor. This will show a center cursor and a family of delta timelines around it. This cursor type is like Sidebands type cursor on the spectrum.
	Shows the spectrum measured along with the spectrum, as defined in the configuration of the corresponding <i>Processing Mode</i> .
	Selects the <i>Processing mode</i> the <i>Widget</i> will show the spectrum from.
	Runout compensation. Requires Order Tracking (Optional software features). Depending on whether a runout Reference signal has already been selected or not, this button may enable several different actions: <ul style="list-style-type: none"> <li>• Set as reference: Select the current position in the timeline to be used as runout reference.</li> <li>• Remove reference: Disables the signal previously selected to act as a reference.</li> <li>• Go to reference: Moves in the timeline to select the position currently selected to be the runout compensation reference.</li> <li>• Activate/Deactivate: Enables or disables runout compensation.</li> </ul> See next sections for a more detailed explanation about Runout Compensation.
	Synchronous view. Requires Order Tracking (Optional software features). Enables several options for waveform representation: <ul style="list-style-type: none"> <li>• Original: Shows the original (non-synchronous) waveform. X-axis will be represented in time units.</li> <li>• Sync. View: Shows a resampled version of the waveform, so that each rotation cycle has the same amount of points. The X-axis is shown in cycles.</li> </ul>



	<ul style="list-style-type: none"> <li>• Sync. Average: Shows a waveform composed of the average value of all the cycles in the original waveform (they are resampled to calculate the average). The displayed waveform will have all cycles to be identical.</li> <li>• Sync. Average (1 cycle): This option is like the previous one, but only shows one revolution cycle. The cycles of the original synchronous waveform are shown in the background, to allow seeing the effect of the average operation.</li> </ul> <p>See next sections for a more detailed explanation about Synchronous View.</p>
	<p>Play waveform as sound using the computer's sound card. The waveform must comply the following two requirements in order to be playable:</p> <ul style="list-style-type: none"> <li>• The duration of the signal must be above 0.5 seconds.</li> <li>• The number of samples must be at least 1000.</li> </ul> <p>Sample rate must be at least 3200 Hz (spectrum frequencies above 1250 Hz)</p>
	<p>Exports the waveform values to CSV format and creates and downloads it into a local file.</p>
	<p>Shows/hides a waveform information box. This box shows the following information associated with the measurement: machine, dynamic point, processing mode, machine speed and load, sensor bias voltage, machine state and alarm condition, maximum and sampling rate of the waveform.</p>



*Note that some cursors and utilities may not be available depending on the characteristics of the original waveform. For example, the "Play waveform" button will not be active if the length of the signal is below 0.5 seconds, or if any of the other limits are not met.*



*Signal acquired with the processing mode long time waveform are not compatible with the audible feature *

### 13.8.3. Zoom

Use the mouse wheel to zoom in and out horizontally on the waveform plot. The *Widget* will zoom the waveform around the sample aligned vertically with the mouse location. After zooming-in use drag and drop with your mouse to move the plot left and right.

In order to make a zoom in a vertical direction, locate the mouse over the Y axis and use the mouse wheel. The spectrum plot will vertically zoom in and out.

Since firmware version 1.0.X it is also possible to use the rectangular zoom, to amplify a specific section of the graph, using the *SHIFT* key and the click and drag gesture of the mouse. This shortcut can also be combined with the keys *CTRL* and *ALT* to specify a vertical or horizontal zoom on a section of the graph.

Click on the *Reset zoom* button to restore the plot to its normal scaling, removing the effect of any previous zoom done on the plot.



### 13.8.4. Cursors

Cursors allow the user to mark any point of the waveform. The *Widget* provides 2 different types: *Single*, and *Delta Time*. The cursor type can be selected using the following icons.



#### Single cursor

After selecting the *Single* cursor icon:



Clicking on the graph will add a *Single* type cursor to waveform. This will show a pop-up window at the top right side of the *Widget* with the amplitude and time values of the waveform point where the cursor is located.

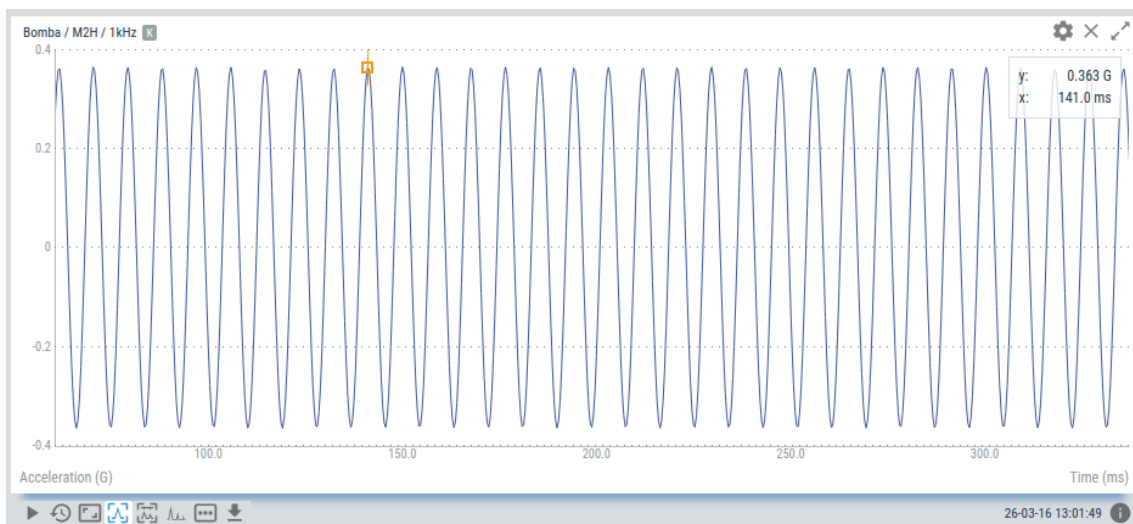

Once the cursor is placed, clicking on the graph again will move the cursor into the line of the waveform point aligned with the mouse click position. The cursor can also be moved by pressing on left and right arrows of the keyboard, jumping from line to line of the waveform. Keys "a" and "s" will move the cursor to the left and right respectively in smaller steps (a tenth of the waveform resolution).

#### Delta Time cursor

*Delta Time* type:



Shows on the waveform, the main cursor and delta timelines around it, like the spectrum sidebands. Once selected clicking on the spectrum will add the center frequency cursor. The center cursor can be moved using the left and right arrows of the keyboard, or "a" and "s" keys for smaller steps.

Once the cursor is on the correct point clicking again on the graph will set this point as the central reference, which will be identified with a red vertical line, and will add the *Delta Time* cursor and its repetitions.



The *Delta Time* cursor can also be shifted using the left and right arrows of the keyboard, which will also move the corresponding harmonic lines.

### 13.8.5. Runout Compensation

When a proximity probe is being used to monitor the gap observed between the bearing and the shaft of a machine, the result is not only a function of the dynamic movement of the shaft, but there is also an effect caused by the irregularities of the shaft surface. The "measured gap" resulting from shaft irregularities is called runout, and includes:

- Mechanical defects: lack of roundness, missing dents, eccentricity, and flat surfaces.
- Electrical effects: Non-uniform electrical properties of the material's shaft surface observed, such as residual magnetism and non-uniform shaft material.

All these effects can be eliminated and corrected by applying a technique known as Runout Compensation, which basically consists of subtracting a Reference signal from the measured signal when the machine is in operation.

Runout compensation is available for both the Waveform and Orbit widgets.

Obviously, demagnetizing, jacketed, machining and/or polishing the shaft surface can minimize the causes of runout, but it is time consuming and not always physically possible or practical. In such a situation it is more cost effective to simply subtract the recorded slow running runout from the actual vibration. This is possible because the runout never changes, regardless of the speed of the machine. Since the runout compensation is a static value, it does not influence the dynamic response of the measurement.

The Reference is usually measured and recorded during slow roll to minimize the unbalanced effects of rotation (i.e. no dynamic movement of the shaft), so only the combined mechanical and electrical runout is seen.

The Vigilant dashboard allows selecting any stored signal to be used as a Reference to apply runout compensation. Any stored signal that appears in the widget timeline can be selected, with the only condition that it contains a complete machine rotation cycle: that is, that there have been at least two equal tachometer flanks.

To be able to perform runout compensation it is necessary that the waveforms of the moving machine are comparable with the waveform of the slow roll signal. To be able to subtract the two signals it is necessary to use the synchronous view explained in the next section.

### 13.8.6. Synchronous View

Comparing different waveforms from a machine in a variable speed regime is often much more difficult than comparing the spectra. The waveforms cannot be overlapped, since by changing the

speed of the machine and keeping the sampling rate constant, there will be a different number of samples for each cycle of the machine.

The Waveform and Orbit widgets have several display options that allow solving this.

The Synchronous View changes the display to show a resampled version of the signals, so that there is always the same number of samples for each machine cycle. The X-axis is no longer displayed in time units, but in machine cycles. The sections of the original waveforms that do not correspond to a complete machine cycle are cut out.

Synchronous Average views also do the same, but they also apply an averaging operation to the waveforms that helps to greatly reduce the effects of unwanted noise in the measurement.

When the time domain of a machine's vibration signal is averaged, the resulting signal gradually builds up the portions of the signal that are synchronized with the tachometer, and other parts of the signal, such as noise and any other components, such as other rotating parts of the machine, etc., are attenuated. Synchronous averaging is useful for waveform analysis especially in the case of gear drives.



The synchronous averaging functionality of the Vigilant is limited, as it only allows averaging the waveform cycles contained in the waveform that has been recorded in a single capture.

The synchronous views require the Order Tracking module to be activated (Optional software features).

## 13.9. Mimic

This *Widget* displays the image associated to the machine, along with its measuring points.

### 13.9.1. Configuration

The following picture shows its configuration settings. Once the *Widget* is selected click on the shortcut key "c" or the button to display its configuration form.

Field	Description
Name	Defines the name to the <i>Widget</i> . It will be shown at its upper bar.
Machine	Selects from the pull-down list the machine mimic to be shown.
Show first parameter value	Show value of the <i>Main parameter</i> below the label of the points.

Image size	Sets the way the image fits on the space of the <i>Widget</i> : <i>Normal</i> will show the image at its normal resolution, <i>Double</i> increases 2 times the size of the image, <i>Cover all</i> fits the image file to the total space available on the <i>Widget</i> .
------------	---

### 13.9.2. Display

The following picture shows the *Mimic Widget* and its components.

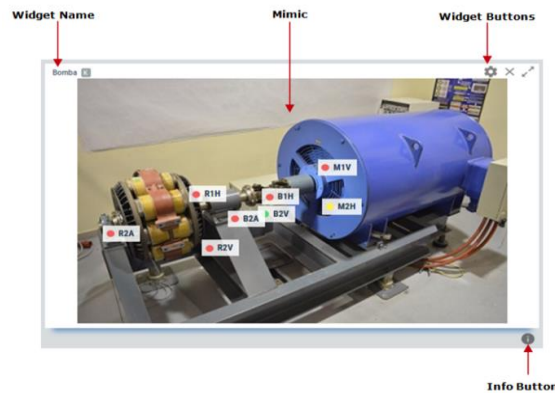

Symbol	Description
	Shows/hides mimic information boxes. This box shows the following information associated with the machine: machine name, speed, load, state, and alarm condition.

### 13.9.3. Points Visualization

The measuring points defined for the machine will be shown in the mimic, represented with a label with its tag. Its location is defined on the configuration of the point, using the "Label" control option, where the user can introduce it graphically.

On the left and side of the label the *Widget* shows the alarm condition of the point with a colored circle. Below the label, it is displayed the value of the *Main parameter* of this point. The *Main parameter* is defined in the configuration web.

## 13.10. Image

This *Widget* displays an image defined by the user but, unlike the Mimic, it does not require to be linked to any Machine or other element.

It may be useful to add custom information to the *Dashboard*.

### 13.10.1. Configuration

The following picture shows its configuration settings. Once the *Widget* is selected click on the shortcut key "c" or the button to display its configuration form.

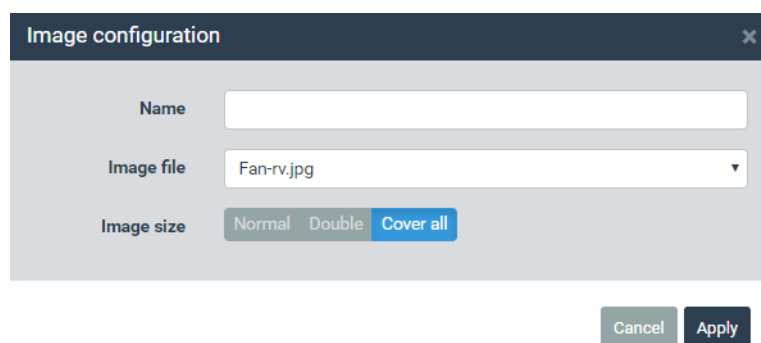

Field	Description
Name	Defines the name to the <i>Widget</i> . It will be shown at its upper bar.
Image size	Sets the way the image fits on the space of the <i>Widget</i> : <i>Normal</i> shows the image at its normal resolution, <i>Double</i> increase 2 times the size of the image, <i>Cover all</i> fits the image file to the total space available on the <i>Widget</i> .

### 13.10.2. Display

The following picture shows the *Image Widget* and its components.

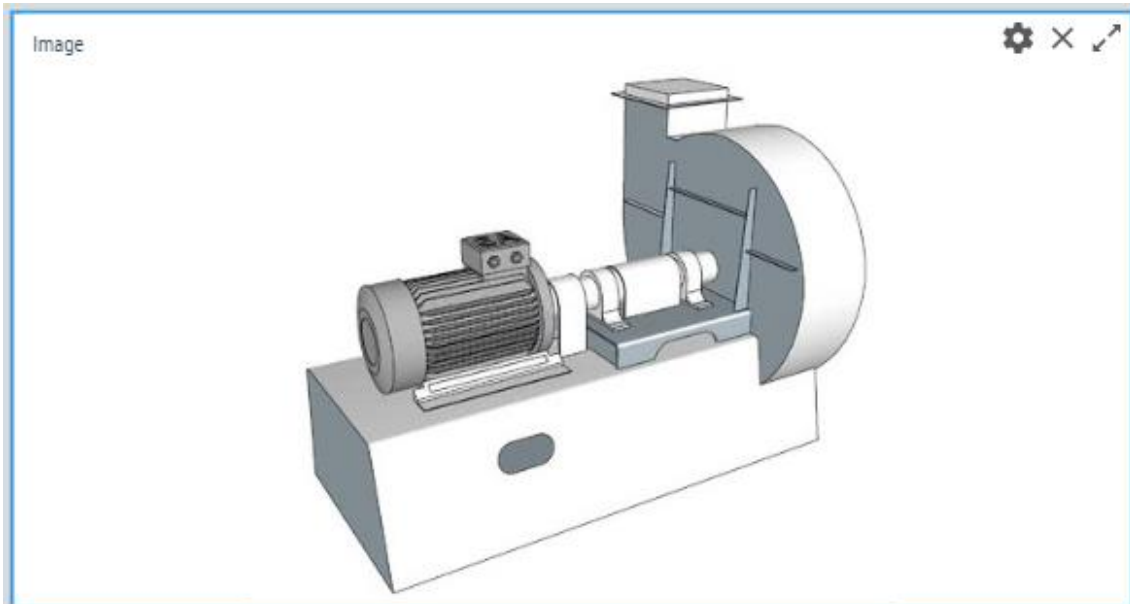

The Image widget has no tools, options, or cursors.

## 13.11. Circular waveform

This *Widget* displays the waveform measurement of a dynamic point in a polar or circular format (Optional software features), representing each shaft revolution around the 360° scale of the Circular waveform. This means the 360° scale will match exactly the period of the shaft speed associated with the corresponding waveform.

### 13.11.1. Configuration

The following picture shows its configuration settings. Once the *Widget* is selected click on the shortcut key "c" or the button to display its configuration form.

<b>Field</b>	<b>Description</b>
Name	Defines the name to the <i>Widget</i> . It will be shown at the upper bar of the <i>Widget</i> .
Line Color	Selects the color of the waveform line.
Machine	Selects the machine of the waveform from the pull-down list.
Point	Selects the dynamic point of the waveform from the pull-down list.
Proc. Mode	Selects the <i>Processing mode</i> of the waveform from the pull-down list.

<b>Field</b>	<b>Description</b>
Speed	Sets the <i>Machine speed</i> the widget will use. By selecting <i>Machine</i> the widget will use the speed measured or defined by the system at that <i>Point</i> . By selecting <i>Custom</i> , the user can set a particular value different from the one measured or configured at that <i>Point</i> .
Remove DC component	Removes the DC component of the waveform.
Max samples per cycle	Selects the maximum number of sample points to show per machine rotating cycle (in between two tachometer edges) when some type of Synchronous View is selected.









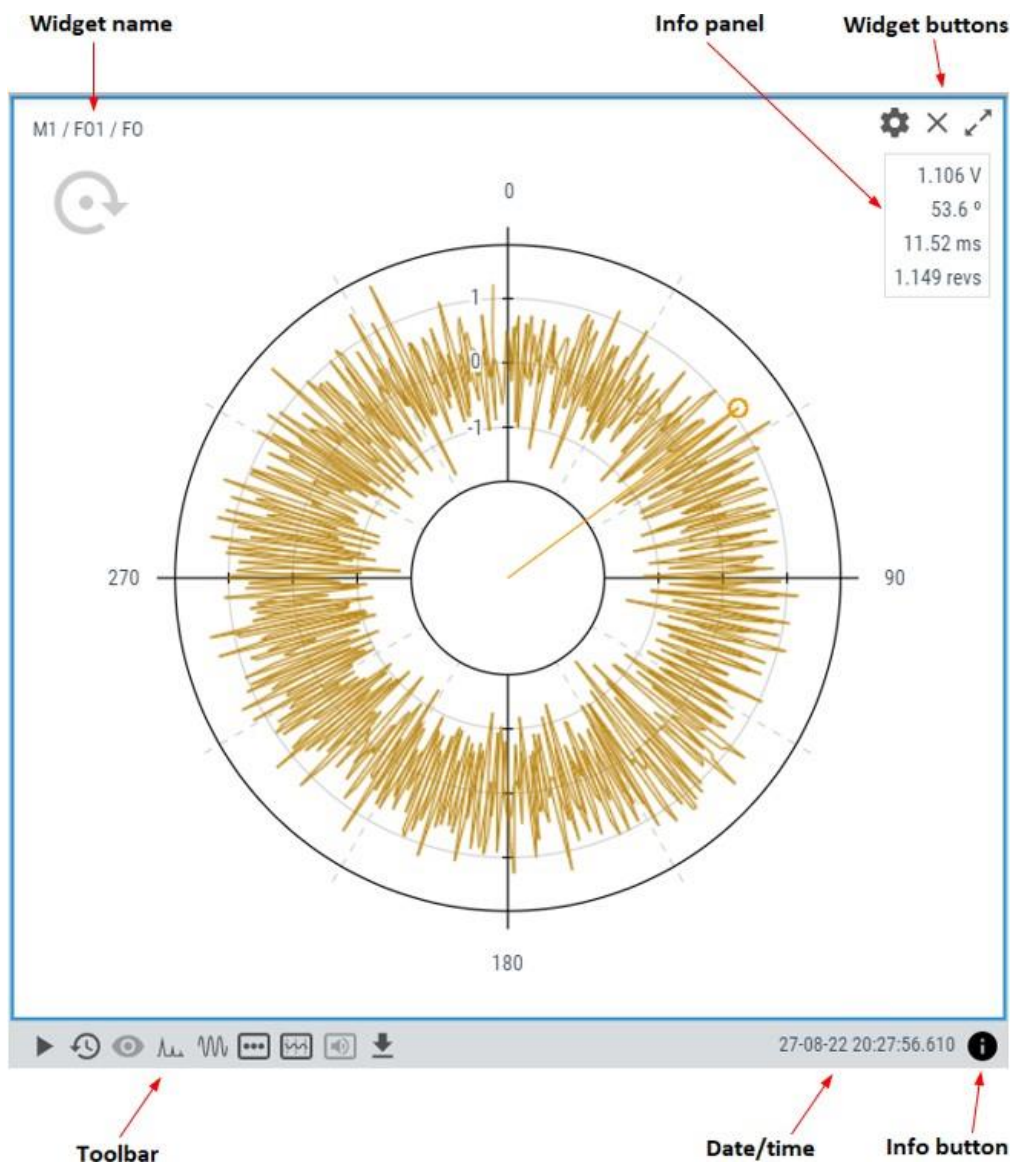



Field	Description
Circular scale lines	Shows or hides polar grid lines on the <i>Widget</i> .
Tacho angle mark	Shows or hides a red line indicating the position of the tachometer trigger. This option is only available with the <i>Sync view</i> option.
Scale position	Defines the location of the amplitude scale. It could be located inside or outside of the Circular waveform.

**13.11.2. Display**

The following picture shows the *Circular waveform Widget* and its components.





<b>Symbol</b>	<b>Description</b>
	The Play/Pause button will make the Circular waveform to be updated automatically with the latest measurement performed by the VIGILANT. The Play state will last for a few minutes and will go back to Pause mode after a while, in order not to waste data bandwidth.
	Shows the Timeline of the waveform measurements. The Timeline presents in a graphical mode the array of waveforms stored on this point for the selected Processing mode. The waveforms are ordered by its date/time on the Timeline and are represented as a vertical bar. The color of the bar represents the machine alarm status at that date. Clicking on any of these bars will update the plot with the Circular waveform for that date. See the Timeline for more information.
	Timeline Filter button will hide the marks in the timeline that do not match to the selected Machine State or Alarm status. Those records will be displayed more diffused in the timeline and it will not be possible to select them.
	Shows in a popup window the spectrum measured along with the waveform, as defined in the configuration of the corresponding Processing Mode.
	Shows in a popup window the waveform in a normal format.
	Selects the Processing mode the Widget will show the Circular waveform from.
	Synchronous view. Requires Order Tracking (Optional software features). Enables several options for Circular waveform representation: <ul style="list-style-type: none"> <li>• Original: Shows the original (non-synchronous) Circular waveform. X-axis will be represented in time units.</li> <li>• Sync. View: Shows a resampled version of the Circular waveform, so that each rotation cycle has the same amount of points. The X-axis is shown in cycles.</li> <li>• Sync. Average: Shows a Circular waveform composed of the average value of all the cycles in the original Circular waveform (they are resampled to calculate the average). The displayed waveform will have all cycles to be identical.</li> <li>• Sync. Average (1 cycle): This option is like the previous one, but only shows one revolution cycle. The cycles of the original synchronous Circular waveform are shown in the background, to allow seeing the effect of the average operation.</li> </ul> See next sections for a more detailed explanation about Synchronous View.
	Plays waveform as sound using the computer's sound card. The waveform must comply the following two requirements in order to be playable: <ul style="list-style-type: none"> <li>• The duration of the signal must be above 0.5 seconds.</li> <li>• The number of samples must be at least 1000.</li> <li>• Sample rate must be at least 3200 Hz (spectrum frequencies above 1250 Hz)</li> </ul>
	Exports the waveform values to CSV format and creates and downloads it into a local file.
	Shows/hides a Circular waveform information box. This box shows the following information associated with the measurement: machine, dynamic point, processing mode, machine speed and load, sensor bias voltage, machine state and alarm condition, maximum and sampling rate of the waveform.

### 13.11.3. Cursor

The Widget provides a Single type cursor that allows the user to mark any point of the waveform. The cursor can be displayed by clicking on the graph or by pressing the left or right keys of the keyboard once the widget has the focus.

Once the cursor is displayed a panel will appear at the top right corner of the widget showing the amplitude of the point selected, angle in degrees, the time in milliseconds and the number of revolutions.

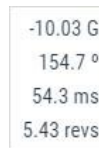

### 13.12. Waterfall

This *Widget* displays three-dimensional plot of a group of spectra, all of them in the same graph, allowing to compare the different measurements and giving information about the evolution of the signal throughout time.

A waterfall graph consists of a series of spectra acquired at consecutive times. The X-axis displays the frequency or order of each point in the spectra. The Z-axis displays the value of the signal. The Y-axis displays the time at which the signal was acquired.

#### 13.12.1. Configuration

The following picture shows its configuration settings. Once the *Widget* is selected click on the shortcut key “c” or the button to display the configuration form.

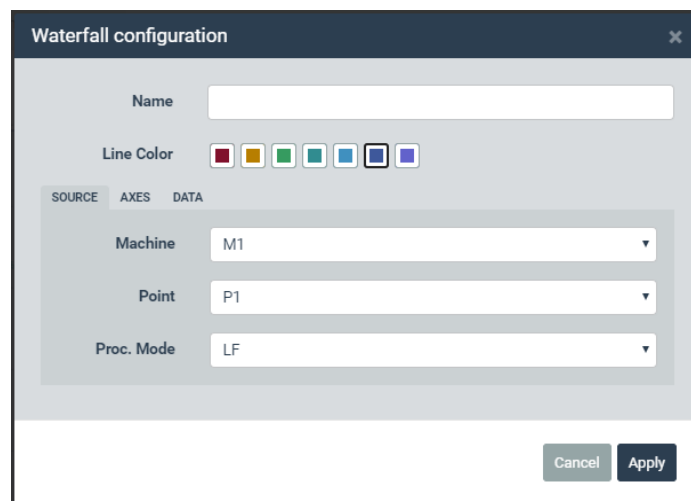

<b>Field</b>	<b>Description</b>
Name	Defines the name of the <i>Widget</i> . It will be shown at the upper bar of the <i>Widget</i> .
Line Color	Selects the color of the waterfall lines.
Machine	Selects the machine of the spectra from the pull-down list.
Point	Selects from the pull-down list the dynamic point of the spectra.
Proc. Mode	Selects the <i>Processing mode</i> of the spectra from the pull-down list.

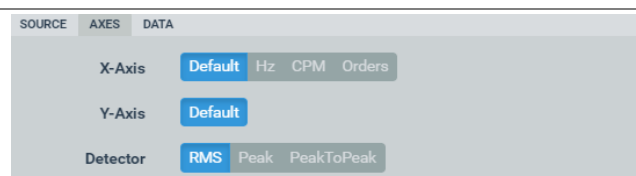

Field	Description
X-Axis	Sets the frequency units for the spectra. Select between <i>Default</i> , <i>Hz</i> , <i>CPM</i> or <i>Orders</i> . <i>Default</i> will use the units defined on the <i>User Preferences</i> .
Y-Axis	Shows the property of the Y axis. For vibration sensors this this field will select between <i>Default</i> , <i>Acceleration</i> , <i>Velocity</i> or <i>Displacement</i> . <i>Default</i> will set the property to the one defined on the <i>Machine-Point-Processing Mode</i> in the <i>main Configuration</i> .
Detector	Selects the detector to be applied to the spectra amplitudes (RMS, Peak, Peak-Peak).

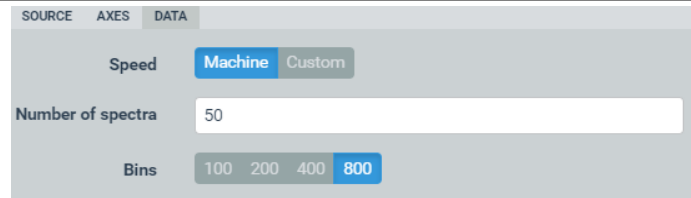







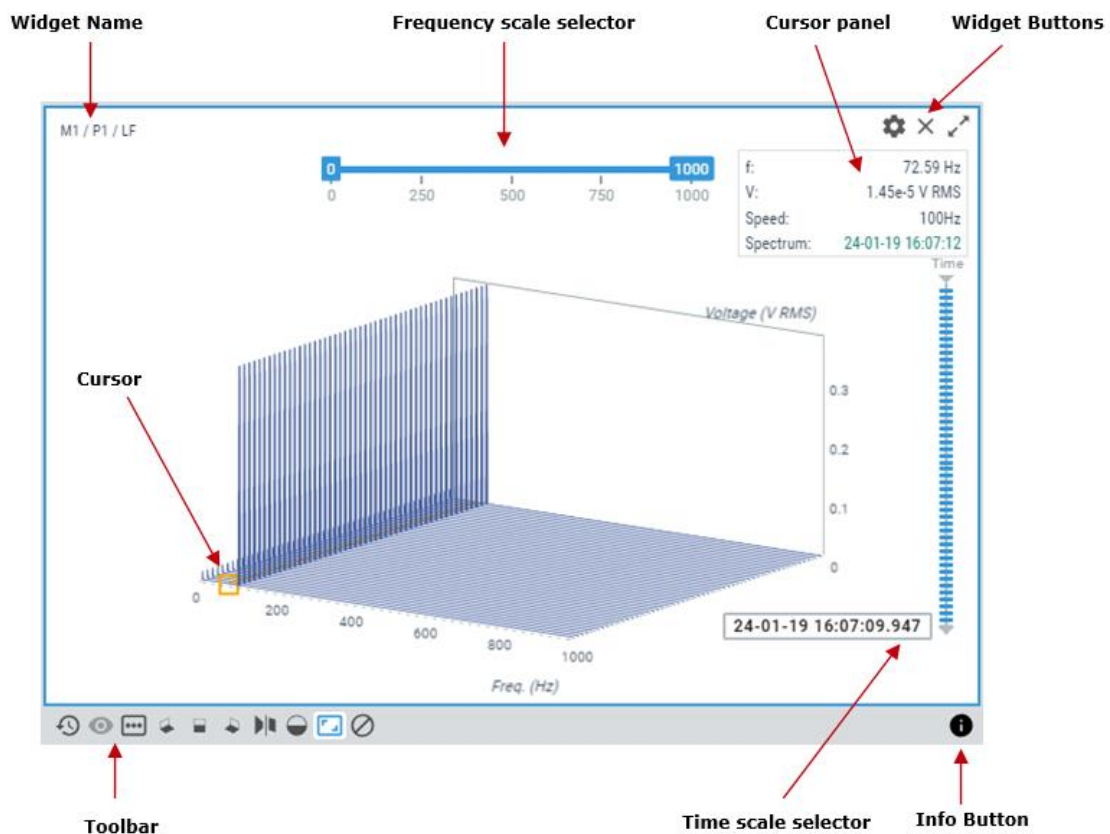

Field	Description
Speed	Configure the widget to use the <i>Machine speed</i> depending on the configuration, or to use a custom user setting. This affects how the cursors behave.
Number of spectra	Maximum number of spectra to represent in Z-axis of the widget.
Bins	The spectra represented in this widget are limited in the number of bins. The higher the number, the more time Dashboard will need to load the widget. This does not affect parameters and other calculations defined in <i>Configuration</i> .

### 13.12.2. Display

The following picture shows the *Waterfall Widget* and its components.



<i>Symbol</i>	<i>Description</i>
	Shows the Timeline of the spectra measurements. The <i>Timeline</i> presents in a graphical mode the array of spectra stored on this point for the selected <i>Processing mode</i> . The spectra are ordered by its date/time on the <i>Timeline</i> and are represented as vertical bars. The color of the bar represents the machine alarm status at that date. The selector above the bars allows configuring the range of dates from which the set of spectra will be chosen.
	<i>Timeline Filter</i> button hides the marks in the timeline that do not match the selected Machine State or Alarm status. Those records will be displayed more diffused in the timeline and it will not be possible to select them.
	A quick link to select from which <i>Processing mode</i> the <i>Widget</i> will be showing the spectra.
	Select standard rotation views.
	Toggle perspective/orthographic view.
	Toggle filled/transparent paths for the spectra (the area below the spectrum becomes opaque)
	Restores the zoom to its normal condition, removing the effect of any previous zoom done on the plot.
	Remove selection button. Hides the cursor and the spectra selection marks.
	Shows/hides the waterfall information box. This box shows the machine, point and processing mode of the spectra.

### 13.12.3. Frequency scale selector

Use the frequency scale selector to amplify different portions of the graph or certain frequencies.

With the help of the mouse, move the controls in each side of the selector, and select the maximum and minimum frequencies that will be plotted in the chart.

### 13.12.4. Time scale selector

The time scale selector allows selecting and moving the cursor to individual spectra more easily and directly than using the keyboard. The selector also gives information about the dates at which the spectra were taken.

The active spectrum will change its fill color, and an information panel will be displayed in the top right corner of the widget, indicating the *speed* of the machine, recorded for that spectrum, and a link to open another *Widget* with that spectrum.



This tool will not be shown if there is not enough screen resolution available to draw all the elements. The minimum resolution depends on the number of spectra to be shown. Note that without a proper size this widget will not be useful.

### 13.12.5. Cursors

Cursors in the *Waterfall* are handled mainly by Keyboard Shortcuts.

Use the *left* and *right* arrows from the keyboard to display the cursors and move through the frequency domain selecting the points in the active spectrum.

Select the active spectrum by using the *up* and *down* arrows from the keyboard, or also using the *Time scale selector*, explained above.

Once the cursor is created, a cursor panel will be displayed up in the right of the widget, indicating the frequency and amplitude of the bin, the *speed* of the machine at the moment of that capture, and a link to open another Widget to show the selected spectrum.

## 13.13. Orbit

This *Widget* displays the orbit graph calculated from two waveform measurements (Optional software features). Typically, two proximity probes mounted orthogonally are used to acquire the signals for this plot. The widget displays the orbit as well as two-time base plots (waveforms), that display the dynamic vibration amplitude information coming from the same sensors as the orbit.

The most common use for orbit plots is to monitor turbomachinery with fluid film bearings. Orbit widget requires a pulse tachometer to determine the velocity of the machine and identify the rotating cycles in the waveforms.

### 13.13.1. Configuration

The following picture shows its configuration settings. Once the *Widget* is selected click on the shortcut key "c" or the button to display its configuration form.

<b>Field</b>	<b>Description</b>
Name	Defines the name to the <i>Widget</i> . It will be shown at the upper bar of the <i>Widget</i> .
Line Color	Selects the color of the orbit line.
Machine	Selects the machine of the waveform from the pull-down list.
X-AXIS	

Point	Selects from the pull-down list the dynamic point of the waveform that will be used for the X-Axis in the orbit. Angle assignment and turning sense are indicated.
Proc. Mode	Selects the <i>Processing mode</i> of the waveform from the pull-down list.
Y-AXIS	
Point	Selects from the pull-down list the dynamic point of the waveform that will be used for the Y-Axis in the orbit. Angle assignment and turning sense are indicated.
Proc. Mode	Selects the <i>Processing mode</i> of the waveform from the pull-down list.



When using Orbits, it is highly advisable to define Components assigned to each couple of points that will be used for the orbits, so that the system will be able to check the correct angles assignments.

<b>Field</b>	<b>Description</b>
Filtering	Apply a filtering composition to the waveforms to extract the main rotational components of the waveforms. A signal reference with any harmonic or sub-harmonic value may be applied to calculate the filtered signal. Sub-harmonic values are indicated by introducing a fraction in the form (only <i>rational</i> numbers are valid).
Max cycles	Select a maximum number of rotating cycles to be displayed in the interface.
Max samples per cycle	Selects the maximum number of sample points to show per machine rotating cycle (in between two tachometer edges) when some type of Synchronous View is selected.



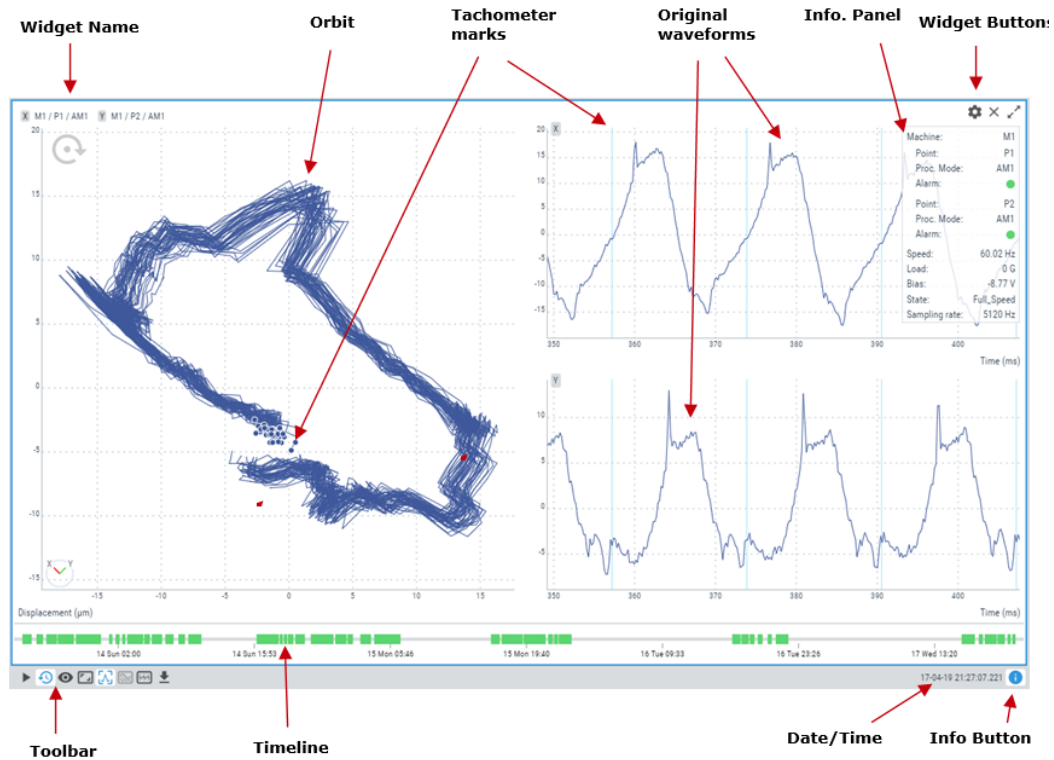

Field	Description
Show waveforms	Shows on the Widget the waveforms from which the orbit is calculated.
Horizontal Lines	Shows or hides horizontal grid lines on the <i>Widget</i> .
Vertical Lines	Shows or hides vertical grid lines on the <i>Widget</i> .

### 13.13.2. Display

The following picture shows the Orbit *Widget* and its components.



Symbol	Description
	The <i>Play/Pause</i> button will make the values of the waveform to be updated automatically with the latest measurement performed by the <i>Vigilant</i> . The <i>Play</i> state will last for a few minutes and will go back to <i>Pause</i> mode after a while, in order not to waste data bandwidth.
	Shows the <i>Timeline</i> of the waveform measurements. The <i>Timeline</i> presents in a graphical mode the array of waveforms stored on this point for the selected <i>Processing mode</i> . The waveforms are ordered by its date/time on the <i>Timeline</i> and are represented as a vertical bar. The color of the bar represents the machine alarm status at that date. Clicking on any of these bars will update the plot with the waveform for that date.
	<i>Timeline Filter</i> button hides the marks in the timeline that do not match the selected Machine State or Alarm status. Those records will be displayed more diffused in the timeline, and it will not be possible to select them.
	Restores the zoom to its normal condition, removing the effect of any previous zoom done on the plot.

	Sets the current cursor as a single cursor type.
	<p>Runout compensation. Requires Order Tracking (Optional software features). Depending on whether a runout Reference signal has already been selected or not, this button may enable several different actions:</p> <ul style="list-style-type: none"> <li>• Set as reference: Select the current position in the timeline to be used as runout reference.</li> <li>• Remove reference: Disables the signal previously selected to act as a reference.</li> <li>• Go to reference: Moves in the timeline to select the position currently selected to be the runout compensation reference.</li> <li>• Activate/Deactivate: Enables or disables runout compensation.</li> </ul> <p>See previous section for a detailed explanation about Runout Compensation.</p>
	<p>Synchronous view. Requires Order Tracking (Optional software features). Enables several options for waveform representation:</p> <ul style="list-style-type: none"> <li>• Original: Shows the original (non-synchronous) waveforms. X-axis will be represented in time units.</li> <li>• Sync. View: Shows a resampled version of the waveforms, so that each rotation cycle has the same length. The X-axis will be shown in cycles.</li> <li>• Sync. Average: Shows waveforms composed of the average value of all the cycles in the original waveforms (they are resampled to calculate the average). The displayed waveforms will have all cycles to be identical.</li> <li>• Sync. Average (1 cycle): This option is like the previous one, but only shows one revolution cycle. The cycles of the original synchronous waveforms are shown in the background, to allow seeing the effect of the average operation.</li> </ul> <p>See previous sections for a detailed explanation about Synchronous View.</p>
	Exports the orbit values to CSV format and creates and downloads it into a local file.
	Shows/hides orbit information box. This box shows the sampling rate of the waveforms.

### 13.13.3. Zoom

Use the mouse wheel to zoom in and out on the graph. The *Widget* will zoom around the cursor position is located on the plot, for both X and Y directions.

After zooming-in use drag and drop with your mouse to move the plot left and right.

Click on the *Reset zoom* button:



to restore the plot to its normal scaling, removing the effect of any previous zoom done on the plot.

### 13.13.4. Single cursor

After selecting the *Single cursor* icon:





from the toolbox, clicking on the graph will add a *Single* type cursor to orbit. This will show a pop-up window at the top right side of the *Widget* with the X and Y values of the orbit.

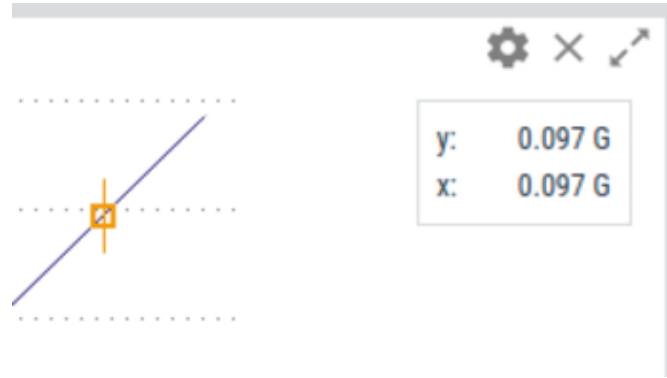

Once the cursor is created, clicking on the graph again will move the cursor into the corresponding point of the orbit. The cursor can also be moved by pressing on left and right arrows of the keyboard, jumping from point to point of the orbit. Keys “a” and “s” will move the cursor to the left and right respectively in smaller steps (a tenth of the distance between points).

### 13.14. Phase Diagram

Phase Diagram, also called Bode and Polar plots, display *peak-phase* parameters in different representations.

The Bode and Polar representations are combined in the same widget, which can be used to describe the locus of a rotational speed vector signal during speed changes.

This is typically used for transient (non-stationary signals) analysis, in both run-up and run-down tests of the machines (Optional software features).

The Bode plot displays in two graphs the values of Peak and Phase as a function of the rotational speed. The graphs can also be configured to be displayed as a function of time (time in X-axis). Bode plots can help identifying the resonance speed of a rotor or examining the rotor dynamics on an order basis.

The Polar plot (also called Nyquist) displays the same data as the Bode, but in polar coordinates, which enables seeing phase changes in the range from 0 to 360 degrees. The Polar plot uses the information about the sensor mounting angles to display the data adjusted to the actual angles defined in the machine. Data coming from orthogonally mounted sensors can be compared using a couple of polar plots.

#### 13.14.1. Configuration

The following picture shows the configuration settings of the *Phase Diagram* widget. Once the *Widget* is selected click on the shortcut key “c” or the button to display its configuration form.

The image shows the 'Phase Diagram configuration' dialog box. It has a title bar with a close button (X). The dialog contains the following fields and options:

- Name:** A text input field.
- Line Color:** A row of seven color selection buttons (red, yellow, green, cyan, blue, dark blue, purple).
- Tabs:** SOURCE, TRENDS, RUNOUT, DATA.
- Machine:** A dropdown menu with 'LP\_Turbine' selected.
- Point:** A dropdown menu with 'MAD31CY005' selected.
- Param:** A dropdown menu with 'PH-1x' selected.
- Buttons:** Cancel and Apply buttons at the bottom right.

Field	Description
Name	Defines the name of the <i>Widget</i> . It will be shown at the upper bar of the <i>Widget</i> .
Line Color	Selects the color of the phase diagram lines.
Machine	Selects the machine from the pull-down list.
Point	Selects from the pull-down list the dynamic point.
Param	Select a <i>Peak/Phase</i> parameter to be displayed, in case there was more than one for this point

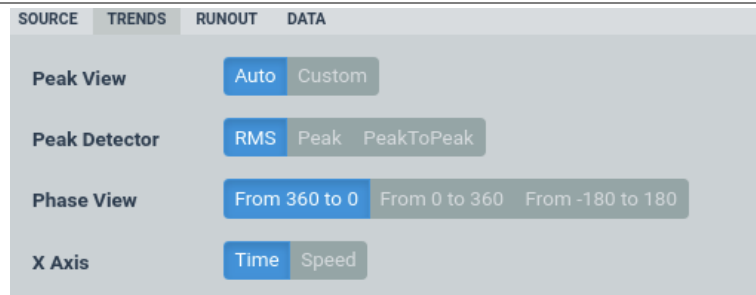

Field	Description
Peak View	Sets the maximum and minimum values visible in the Y axis. Note that clicking on the Reset zoom button with this option enabled reset it to the values set in this form.
Peak Detector	Selects the detector to be applied to the peak amplitudes (RMS, Peak, Peak-Peak)
Phase View	Configure how the angles are displayed in the phase view of the Bode plot.
X Axis	Configure to order the points in the X-axis using the timestamp or the speed of the machine (real Bode view).

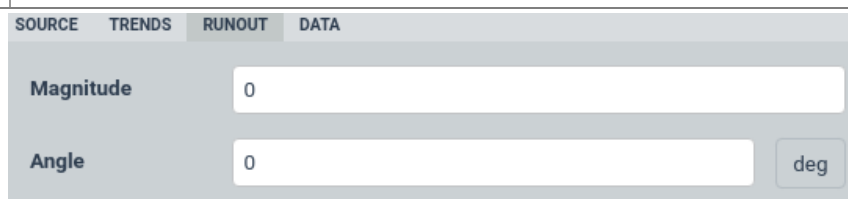

Runout is measured and recorded during slow roll to minimize the unbalance effects of rotation (i.e. no dynamic shaft movement).

Field	Description
Magnitude (runout)	Magnitude value to compensate for the runout position of the shaft.
Angle (runout)	Angular value to compensate for runout position of the shaft.



Runout reference may be set directly from the display mode using the link available in the cursor window.

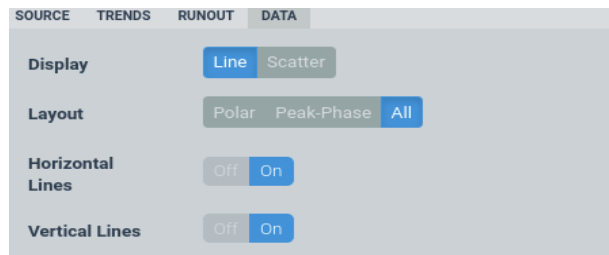



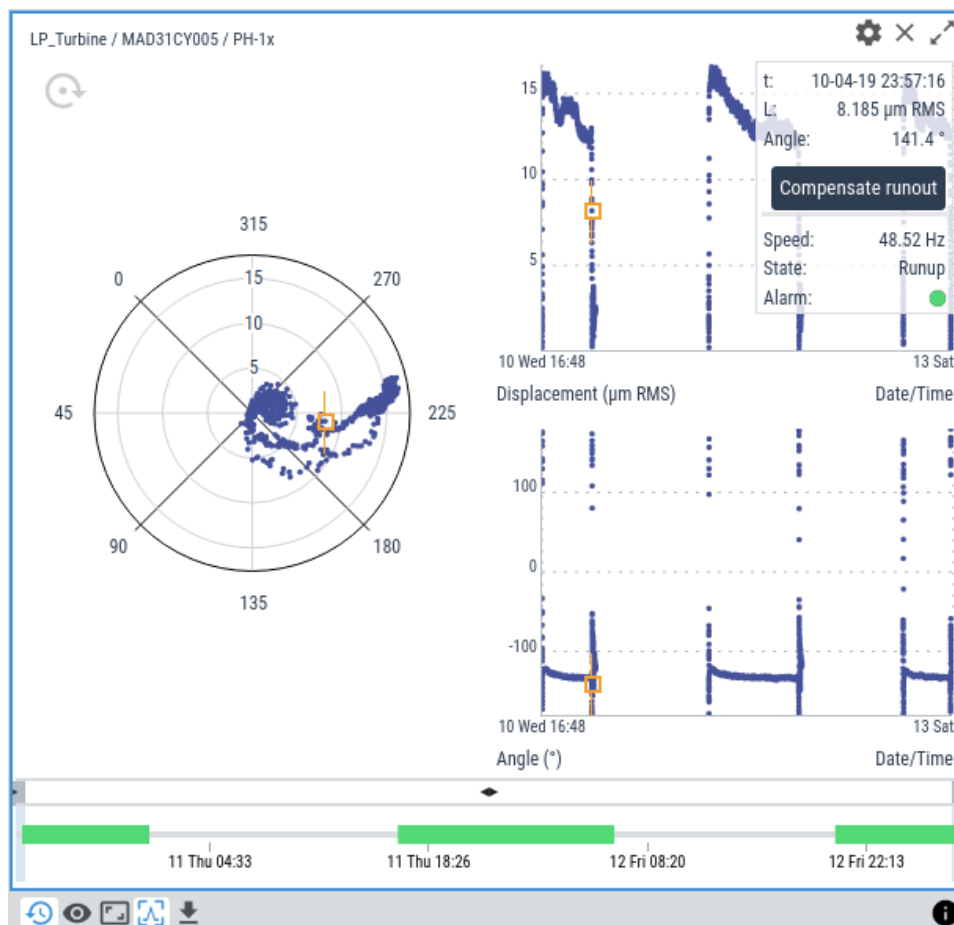

Field	Description
Display	Use (or not) lines to connect the points in between.
Layout	Show Bode, Polar, or both Plots
Horizontal Lines	Shows or hides horizontal grid lines on the <i>Widget</i> .
Vertical Lines	Shows or hides vertical grid lines on the <i>Widget</i> .

### 13.14.2. Display

The following picture shows the phase plots *Widget* and its components.



Symbol	Description
	Timeline: select which part of the storage will be used as source data for the phase plots.

	Phase D. filter behaves similar as the filter in Trends. The button allows selecting which machine state and alarm status to show, and the rest of the points get hidden. Note that the points' alarm status is calculated when the data was stored and may not match with actual settings.
	Restores the zoom to its normal condition, removing the effect of any previous zoom done on the plot.
	Sets the current cursor as a single cursor type.
	Exports the Phase Plot values to CSV format and creates and downloads it into a local file.
	Shows/hides mimic information boxes. This box shows the following information associated with the machine: machine name, speed, load, state and alarm condition.

### 13.14.3. Single cursor

The *Single* cursor is selected by default in this widget.

Clicking on any point of the graphs, this will show a pop-up window at the top right side of the *Widget* with the following information:



- t: timestamp of the capture.
- L: Peak value of the parameter.
- Angle: Phase value of the parameter.
- (Compensate runout): Sets runout reference at this capture.
- Speed: Speed of the machine at that capture.
- State: State of the machine at that capture
- Alarm: Alarm state of the machine at that capture.

Once the cursor is created clicking on the graph again will move the cursor into the corresponding point of the graph. The cursor can also be moved by pressing on left and right arrows of the keyboard, jumping from point to point of the orbit.

### 13.15. Long Waveform

This *Widget* displays a long waveform capture, using an envelope view instead of the full waveform. Different analysis tools allow decomposing this long duration signal, extracting spectra, parameters, etc.

### 13.15.1. Configuration

The following picture shows its configuration settings. Once the *Widget* is selected click on the shortcut key “c” or the button in order to show its configuration form.

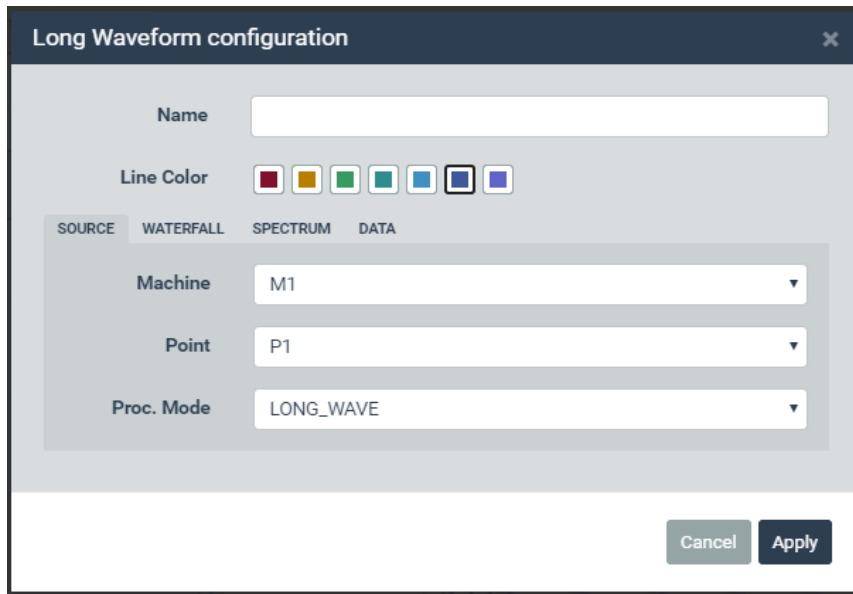

Field	Description
Name	Defines the name of the <i>Widget</i> . It will be shown at the upper bar of the <i>Widget</i> .
Line Color	Selects the color of the long waveform lines.
Machine	Selects the machine from the pull-down list.
Point	Selects from the pull-down list the dynamic point.
Proc. Mode	Selects the <i>Processing mode</i> of the long waveform from the pull-down list.

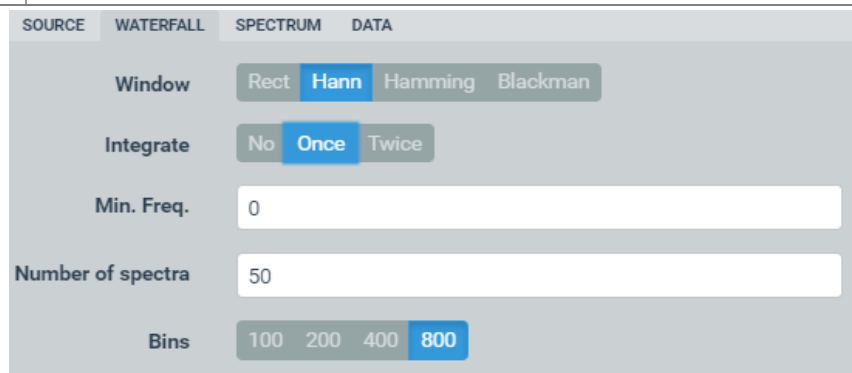

Field	Description
Window	Select type of window to calculate the spectra: <ul style="list-style-type: none"> <li>• Rectangular.</li> <li>• Hann.</li> <li>• Hamming.</li> <li>• Blackman.</li> </ul>

Integrate	Sets up if the data has to be integrated once or twice. Acceleration integrates to velocity, and this to displacement.
Min. Freq.	Sets the minimum frequency calculated for the spectrum. The maximum is set by the sampling frequency of the signal.
Number of spectra	Sets the default number of spectra displayed in the waterfall.
Bins	Sets the number of bins to be displayed in spectra: 100/200/400/800

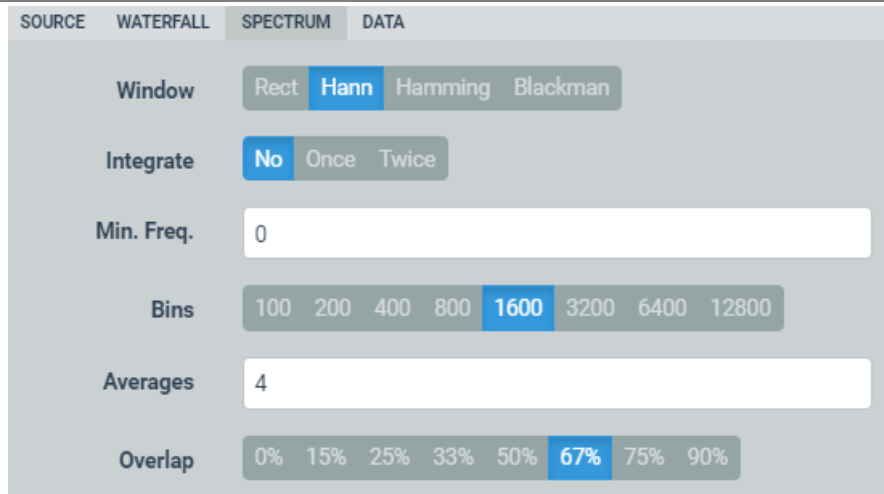

Field	Description
Window	Select type of window to calculate the spectra: <ul style="list-style-type: none"> <li>• Rectangular.</li> <li>• Hann.</li> <li>• Hamming.</li> <li>• Blackman.</li> </ul>
Integrate	Sets up if the data has to be integrated once or twice. Acceleration integrates to velocity, and this to displacement.
Min. Freq.	Sets the minimum frequency calculated for the spectrum. The maximum is set by the sampling frequency of the signal.
Bins	Sets the number of bins to be displayed in spectra: 100/200/400/800
Averages	Sets the number of averages to calculate the spectrum (1-8)
Overlap	Sets the percentage of overlapping between waveform cuts used to calculate the spectrum.

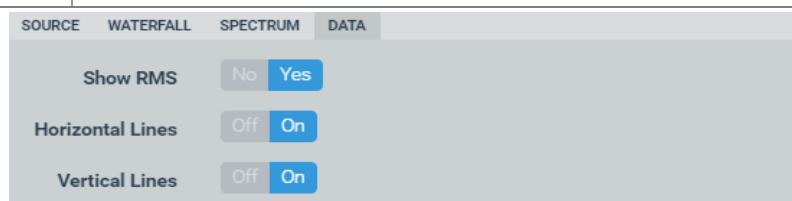

Field	Description
Show RMS	Shows or hides the trend of the RMS value along the waveform

Horizontal Lines	Shows or hides horizontal grid lines on the <i>Widget</i> .
Vertical Lines	Shows or hides vertical grid lines on the <i>Widget</i> .

### 13.15.2. Display

The following picture shows the Long-Waveform *Widget* and its components.

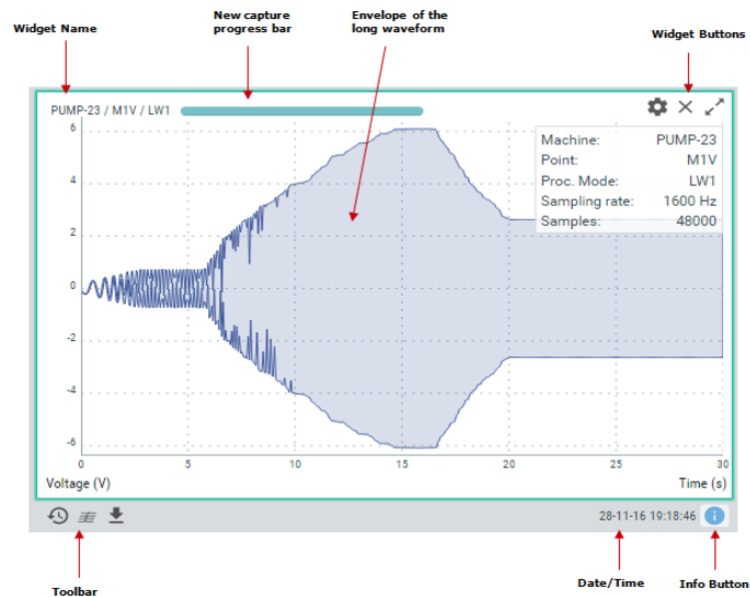

Symbol	Description
	Timeline: select which waveform will be displayed from storage.
	Display the waterfall's spectrum calculated from the long waveform. It calculates several spectra from portions of the waveform, according to the settings, and shows them in a waterfall.
	Exports the long waveform to a WAV file and downloads it to a local file.
	Shows/hides information boxes. This box shows the sampling rate and number of samples in the waveform.

### 13.15.3. Single cursor

The long waveform widget allows two cursor options, automatically selected with the mouse movements applied over the widget.

By making a single mouse click on the signal, the system will select a certain point from it, from which it will be possible to extract a spectrum diagram according to the configuration applied to the widget. The cursor panel will display information about the selected point:

- t: position in time of the cursor.
- V1 / V2: maximum and minimum amplitude values of the envelope at that moment.
- rms / p / pp: values of the magnitude parameters of the wave, also in that specific point.
- Spectrum: direct link to a pop-up window, in which a spectrum widget will be calculated and shown accordingly to the configuration of the long waveform widget.

By clicking and dragging with the mouse over the plot a different type of cursor will appear, which will allow us selecting a specific area of the waveform. In this case, the cursor box will display the following information:

- t0 / t1: start and end time values for the selected signal area.
- Waterfall: direct link to a pop-up widget with a waterfall plot of the area selected by the cursor, calculated accordingly to the settings applied in the long waveform widget.



Do not confuse access to waterfall available from the cursor with the button available at the bottom of the widget. The first one will show the waterfall of a portion of the signal, while the button will always calculate the waterfall of the complete signal.

## 13.16. Shaft Centerline

The *Shaft Centerline* plot is designed to show changes in the average radial position of the shaft (Optional software features).

When a rotor system with hydrodynamic bearings changes speed or load, the stiffness and damping characteristics of the bearings are also modified. As a result, changes in the average radial position of the shaft will also be observed.

Primary and secondary machinery malfunctions such as misalignment, fluid-induced instability, and rubs, to name a few, can produce significant changes in the rotor's radial position within the bearings or seals.

These changes in radial shaft position can be directly observed via the *Shaft CenterLine* plot.

To draw this graph, two displacement measures, normally collected by means of proximity probes, are needed as sources. As in the case of the Orbit graph, the two points must be placed orthogonally to reconstruct the position of the shaft in two dimensions.

### 13.16.1. Configuration

The following picture shows the configuration settings of the *Shaft Centerline* widget. Once the *Widget* is selected click on the shortcut key "c" or the button to display its configuration form.

Field	Description
Name	Defines the name of the <i>Widget</i> . It will be shown at the upper bar of the <i>Widget</i> .
Line Color	Selects the color of the shaft centerline plots.



Machine	Selects the machine from the pull-down list.
Point	Selects from the pull-down list the dynamic point. Angle assignment and turning sense are indicated.
Param	Selects the parameter to be used to create the plot. Only <i>mean</i> type parameters are valid for creating this plot.



Only *Points* with *Mean* type parameters, and using a **displacement unit**, are valid for creating *Shaft Centerline Plots*.

X SOURCE
Y SOURCE
CLEARANCE
DATA

Horizontal	<input type="text" value="300"/>	<input type="button" value="µm"/>
Vertical	<input type="text" value="300"/>	<input type="button" value="µm"/>
X zero	<input type="text" value="-1234.93701171875"/>	<input type="button" value="µm"/>
Y zero	<input type="text" value="-1305.2410888671875"/>	<input type="button" value="µm"/>

Field	Description
Horizontal (clearance)	Sets the maximum horizontal clearance that the axis is supposed to have into the shaft area. Indicates the theoretical maximum displacement in X axis and sets the width of the shaft drawing.
Vertical (clearance)	Sets the maximum vertical clearance that the axis is supposed to have into the shaft area. Indicates the theoretical maximum displacement in Y axis and sets the height of the shaft drawing.
X zero	Sets the position of the axis in allegedly rest mode (when speed is zero or close to zero).
Y zero	Sets the position of the axis in allegedly rest mode (when speed is zero or close to zero).

X SOURCE
Y SOURCE
CLEARANCE
DATA

Draw Clearance	<input type="button" value="No"/>	<input checked="" type="button" value="Yes"/>
Show Trends	<input type="button" value="No"/>	<input checked="" type="button" value="Yes"/>
Display	<input type="button" value="Line"/>	<input checked="" type="button" value="Scatter"/>
Horizontal Lines	<input type="button" value="Off"/>	<input checked="" type="button" value="On"/>
Vertical Lines	<input type="button" value="Off"/>	<input checked="" type="button" value="On"/>

Field	Description
Draw Clearance	Draw a circle (or ellipse) representing maximum shaft clearance.
Show Trends	Display two plots on the right of the widget showing trends.

Display	Use (or not) lines to connect the points in between.
Horizontal Lines	Shows or hides horizontal grid lines on the <i>Widget</i> .
Vertical Lines	Shows or hides vertical grid lines on the <i>Widget</i> .

**13.16.2. Display**

The following picture shows the Shaft CenterLine plot *Widget* and its components.

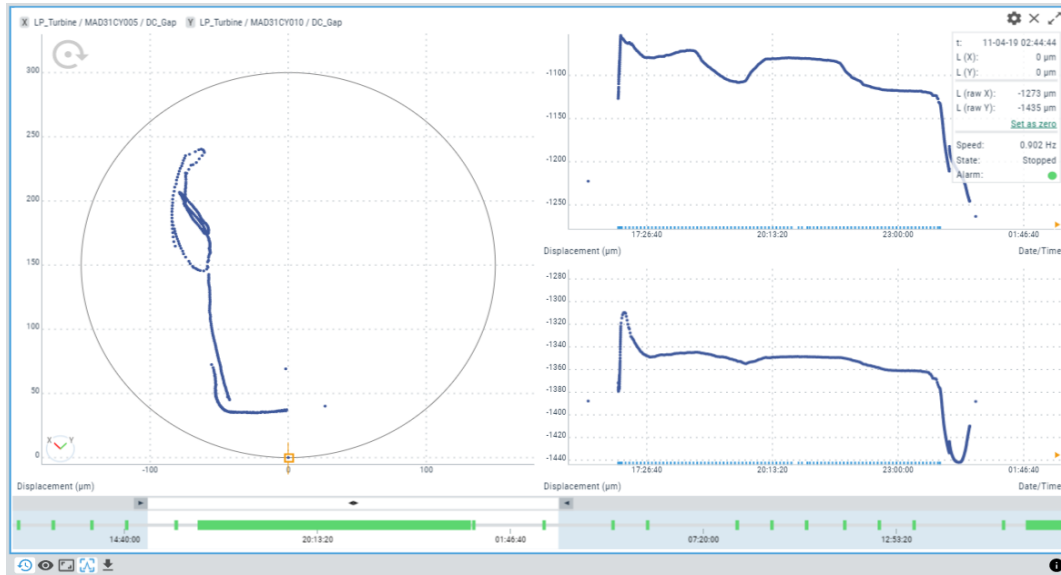

Symbol	Description
	Timeline: select which part of the storage will be used as source data for the shaft centerline plot.
	SCL filter behaves similar as the filter in Trends. The button allows selecting which machine state and alarm status to show, and the rest of the points will get hidden. Note that the alarm status of the points was calculated when the data was being stored and may not match with actual settings.
	Restores the zoom to its normal condition, removing the effect of any previous zoom done on the plot.
	Sets the current cursor as a single cursor type.
	Exports the SCL Plot values to CSV format and creates and downloads it into a local file.
	Shows/hides SCL information box. This box shows the following information associated to the machine: machine name, points names, and parameters names.

**13.16.3. Single cursor**

The *Single* cursor is selected by default in this widget.

Clicking on any point of the graphs (either the main SCL plot or the trends), this will launch a notification box at the top right side of the *Widget* with the following information:

- t: timestamp of the point.
- L(X): Corrected horizontal position of the shaft center, after applying angular correction and subtracting Zero origins.
- L(Y): Corrected horizontal position of the shaft center, after applying angular correction and subtracting Zero origins.
- L (raw X): Horizontal position of the shaft center. Raw data, without clearance compensation.
- L (raw Y): Vertical position of the shaft center. Raw data, without clearance compensation.
- “Set as zero”: Sets the selected point as the origin of coordinates, so that its position is used to calculate corrected positions.
- Speed: Speed of the machine at the selected point.
- State: State of the machine at the selected point.
- Alarm: Overall alarm state of the machine at the selected point.

Once the cursor is created clicking on the graph again will move the cursor into the corresponding point of the graph. The cursor can also be moved by pressing on left and right arrows of the keyboard, jumping from point to point of the orbit.

### 13.17. Full spectrum

This *Widget* displays the Full spectrum measurement related to two orthogonal probes (Optional software features).

#### 13.17.1. Configuration

The following picture shows its configuration settings. Once the *Widget* is selected click on the shortcut key “c” or the button to display its configuration form.

Field	Description
Name	Defines the name to the <i>Widget</i> . It will be shown at the upper bar of the <i>Widget</i> .
Line Color	Selects the color of the Full spectrum line.
Machine	Selects the machine of the Full spectrum from the pull-down list.
Point	Selects the dynamic point of the Full spectrum from the pull-down list.
Proc. Mode	Selects the <i>Processing mode</i> of the Full spectrum from the pull-down list.

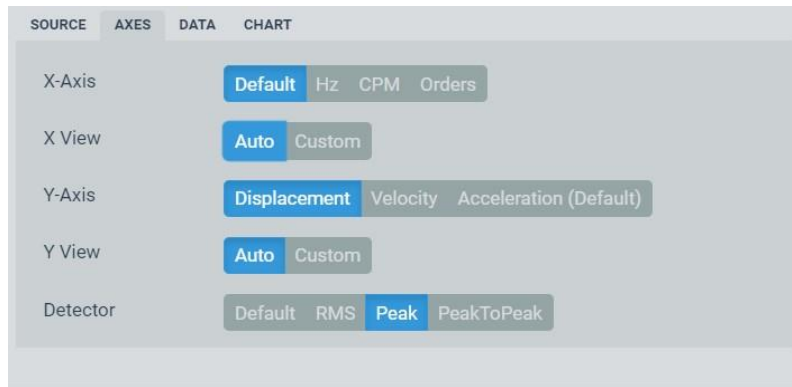

Field	Description
X-Axis	Sets the frequency units of the Full spectrum. Select between <i>Default</i> , <i>CPM</i> , <i>Hz</i> or <i>Orders</i> . <i>Default</i> will use the units defined on the <i>User Preferences</i> .
X View	Sets the maximum and minimum values visible in the X axis. Note that clicking on the <i>Reset zoom</i> button with this option enabled will reset it to the values set in this form.
Y-Axis	Shows the property of the Y axis. For vibration sensors this field selects between <i>Acceleration</i> , <i>Velocity</i> or <i>Displacement</i> . The one defined on the <i>Machine-Point-Processing Mode</i> in the <i>main Configuration</i> will be shown as <i>Default</i> .
Y View	Sets the maximum and minimum values visible in the Y axis. Note that clicking on the <i>Reset zoom</i> button with this option enabled resets it to the values set in this form.
Detector	Selects the detector to be applied to the spectrum amplitude (RMS, Peak, Peak-Peak).

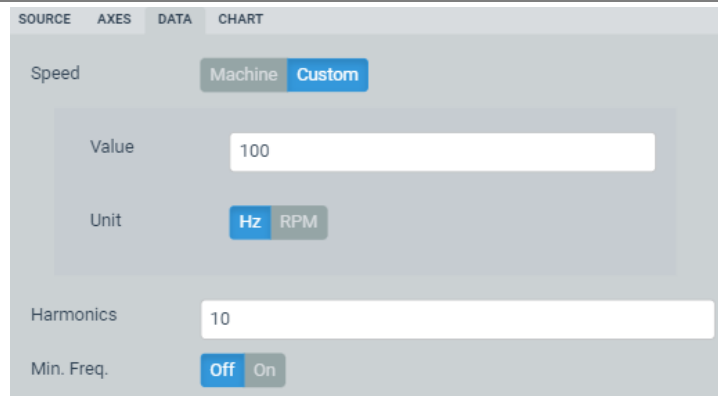

Field	Description
Speed	Sets the <i>Machine speed</i> the widget will use. By selecting <i>Machine</i> , the widget will use the speed measured or defined by the system at that <i>Point</i> . By selecting <i>Custom</i> , the user can set a particular value different from the one measured or configured at that <i>Point</i> . This affects the calculation of the <i>Order</i> units of the frequencies.
Harmonics	Sets the number of harmonics the <i>Harmonic</i> and <i>Side Band</i> cursor will show.
Min. Freq.	Sets a minimum frequency, in absolute value, that will be applied both to the positive and negative axis. Spectrum lines below that frequency will be displayed as 0.









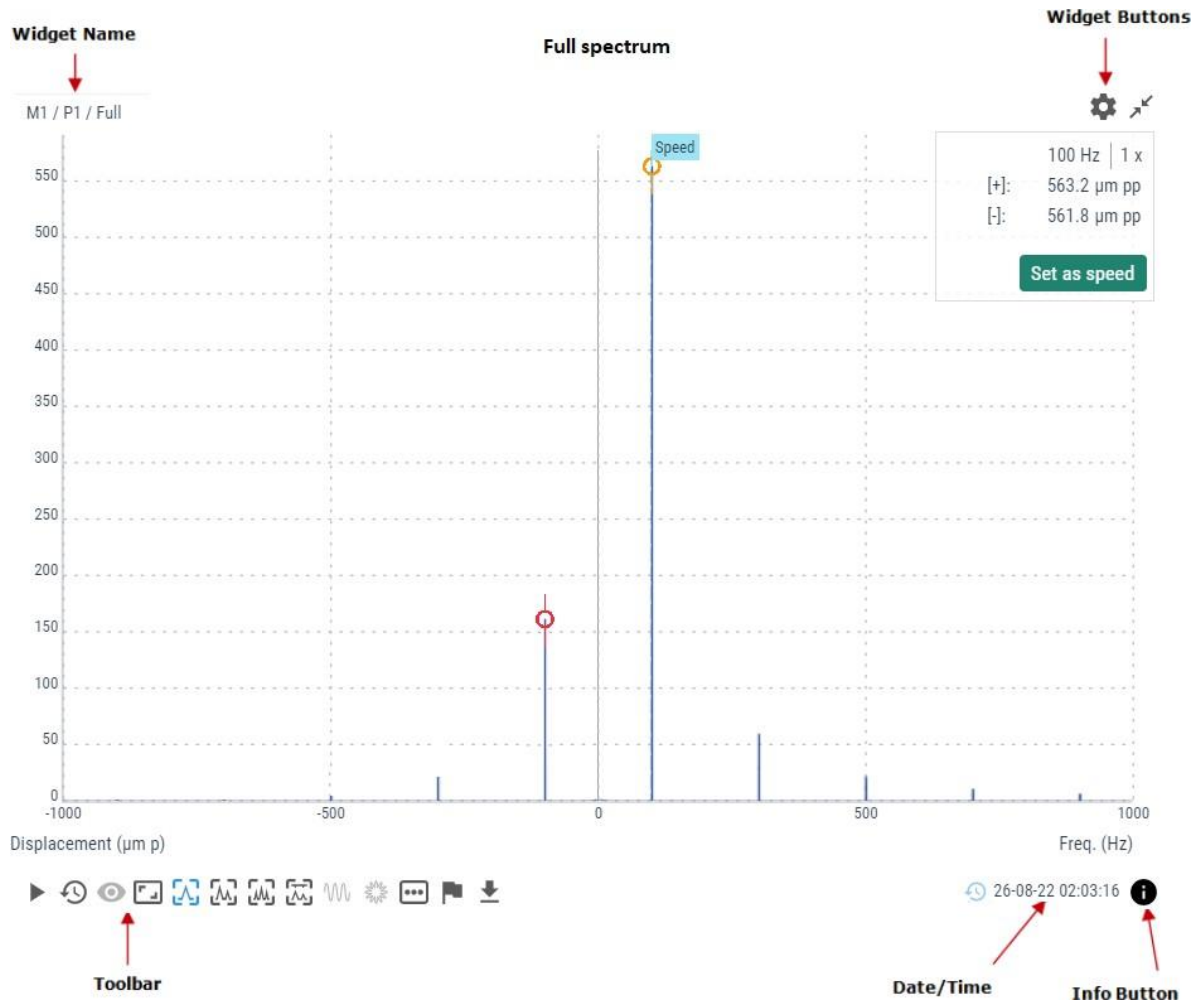



Field	Description
Horizontal Lines	Shows or hides horizontal grid lines on the <i>Widget</i> .
Vertical Lines	Shows or hides vertical grid lines on the <i>Widget</i> .

### 13.17.2. Display

The following picture shows the Full spectrum *Widget* and its components.



Symbol	Description
	The <i>Play/Pause</i> button will make the values of the Full spectrum to be updated automatically with the latest measurement performed by the <i>system</i> . The <i>Play</i> state will last for a few minutes and will go back to <i>Pause</i> mode after a while in order not to waste data bandwidth.
	<i>Pause</i> button will freeze the current spectrum, so the plot will not be updated with new measurements.
	Shows the <i>Timeline</i> of the spectrum measurements. The <i>Timeline</i> presents in a graphical mode the array of spectra stored on this point for the selected <i>Processing mode</i> . The spectra are ordered by its date/time on the <i>Timeline</i> and are represented as a vertical bar. The color of the bar represents the machine alarm status at that date. Clicking on any of these bars will update the plot with the Full spectrum for that date. See <i>Timeline</i> for more information.
	<i>Timeline Filter</i> button will hide the marks in the timeline that do not match the selected Machine State or Alarm status. Those records will be displayed more diffused in the timeline and it will not be possible to select them.

	<i>Restores the zoom to its normal condition, removing the effect of any previous zoom done on the plot.</i>
	<i>Sets the current cursor as a single cursor type. For each cursor selected the Widget will show the symmetrical cursor on the other side of the Full spectrum.</i>
	<i>Sets the current cursor as a harmonic type cursor. This will show the main frequency selected and the number of harmonics defined on the configuration of the Widget. For each cursor selected the Widget will show the symmetrical cursor on the other side of the Full spectrum.</i>
	<i>Sets the current cursor as a side band type cursor. This will show a center frequency and sidebands around it, each of them with the number of harmonics defined on the configuration of the Widget.</i>
	<i>Not used with Full spectrum.</i>
	<i>Not used with Full spectrum</i>
	<i>Selects the Processing mode the Widget will show the Full spectrum from.</i>
	<i>Shows the list of Fault Frequencies defined for the corresponding dynamic point. Selecting one of them will show on the Full spectrum plot the Fault Frequency as a dotted red line, along with the harmonics defined on its configuration.</i>
	<i>Exports the spectrum values to CSV format and creates and downloads it into a local file.</i>
	<i>Shows/hides spectrum information box. This box shows the following information associated with the measurement: machine, dynamic point, processing mode, machine speed and load, sensor bias voltage, machine state and alarm condition, maximum and minimum frequency of the spectrum.</i>

### 13.17.3. Zoom

Use the mouse wheel to zoom in and out horizontally on the Full spectrum plot. The *Widget* will zoom the spectrum around the frequency aligned vertically with the mouse location. After zooming-in use drag and drop with your mouse to move the plot left and right.

To make a zoom in the vertical direction, locate the mouse over the Y axis and use the mouse wheel. The spectrum plot will vertically zoom in and out.

Since firmware version 1.0.X it is also possible to use the rectangular zoom, to amplify a specific section of the graph, using the *SHIFT* key and the click and drag gesture of the mouse. The *SHIFT* key can also be combined with the keys *CTRL* and *ALT* to specify a vertical or horizontal zoom on a section of the graph.

Click on the *Reset zoom* button to restore the plot to its normal scaling, removing the effect of any previous zoom done on the plot.



### 13.17.4. Fault Frequencies

This option shows on the Full spectrum plot the fault frequencies assigned to the measurement point.

Fault frequencies are those related to different failure modes on the machine (gear mesh, ball bearing, RPM harmonics, belts, etc.). These frequencies are defined on the configuration of the system and can be assigned to the different dynamic points.

By clicking on the icon:



the Widget will show the list of *Fault Frequencies*.

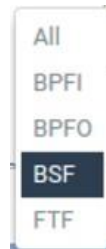

By selecting one of them the corresponding *Fault Frequency* will be represented on the spectrum plot as a dotted vertical line, along with its harmonics. The number of harmonic lines is defined on the configuration of the *Fault Frequency*.

#### 13.17.5. Cursors

Cursors allow the user to mark any frequency of the spectrum. The *Widget* provides 3 different types of cursors: *Single*, *Harmonic* and *Side Band*.

##### Single cursor

After selecting the *Single* cursor icon clicking on the graph will add a *Single* type of cursor to the Full spectrum, along with the symmetrical one on the other side of the plot.



The cursor can be moved by using the left and right arrows of the keyboard. Keys “a” and “s” will move the cursor to the left and right respectively in smaller steps (a tenth of the spectrum resolution). On the other hand, by pressing the upwards arrow of the keyboard the *Widget* calculates the amplitude and frequency with more accuracy using mathematical methods.

By selecting this cursor, the *Widget* will present a window at the top right side, with the amplitude and frequency values where both cursors are located. The *Set as speed* button sets the speed of the Full spectrum as the frequency selected by the cursor.

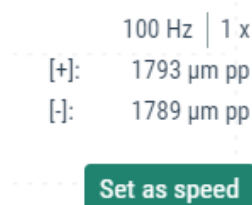

##### Harmonic cursor

After selecting the *Harmonic* cursor icon clicking on the graph will add Harmonic type cursors to the Full spectrum. This cursor type will show the main frequency selected and the number of harmonics defined on the configuration of the *Widget*, along with the symmetrical ones on the other side of the plot.



The main cursor can be moved by using the left and right arrows of the keyboard. The main cursor is identified by a vertical line crossing the cursor itself. Keys “a” and “s” will move the cursor to the left and right respectively in smaller steps (a tenth of the spectrum resolution). On the other hand, by pressing the upwards arrow of the keyboard the *Widget* calculates the amplitude and frequency with more accuracy using mathematical methods.

By selecting this cursor, the *Widget* will present a window at the top right side, with the amplitude and frequency values where both cursors are located. The *Show all points* button presents the list of all harmonic cursors.

100 Hz | 1 x  
 [+] 1793  $\mu$ m pp  
 [-] 1788  $\mu$ m pp  
 Show all points

### Side band cursor

The *side band* cursor will show on the Full spectrum a center frequency and sidebands around it, each of them with the number of harmonics defined on the configuration of the *Widget*.



Once selected, clicking on the Full spectrum will add the center frequency cursor. The center cursor can be moved using the left and right arrows of the keyboard, or “a” and “s” keys for smaller steps. Upwards arrow of the keyboard the *Widget* can also be used to calculate the amplitude and frequency with more accuracy using mathematical methods.

Once the cursor is on the correct frequency peak, clicking again on the graph will set this frequency as the central one, which will be identified with a red vertical line, and add the sideband cursor and its harmonics. Sideband cursor can also be moved using the left and right arrows of the keyboard, which will also move the corresponding side bands harmonics.

When selecting this cursor, the *Widget* will present a window at the top right side with the amplitude and frequency values where the main cursor is located, plus the frequency difference between the main cursor and the first sideband. The *Show all points* button presents the list of all sideband cursors.

100 Hz | 1 x  
 1793  $\mu$ m pp  
 $\Delta$ f: 26.56 Hz  
 Show all points



## 14. Maintenance

### 14.1. Relevant aspects

The *Vigilant* does NOT require any consumable material for its normal operation.

With use, problems can be detected, after some time, with the following elements:

- **Permanent storage.** The *Vigilant* uses an internal micro-SD memory card for permanent storage of the measurement data. The device comes by default with a flash memory card with a total capacity of 4Gb. Although **Vigilant** is using industrial range SD cards with pSLC technology for this feature, and that minimizes the risk of data loss or corruption, the flash technologies used in micro-SD cards are subject to failure, and thus incidents with the SD storage are in the long term inevitable. Read carefully following chapters about [Micro-SD card maintenance](#) to learn how to handle it.
- **Accuracy of measurements.** If after a time of obtaining the equipment, it is detected that the measurement is not as accurate as expected, it may be necessary to refine the calibration. If this occurs, please contact your equipment provider.

### 14.2. Periodic inspections

The system requires periodic inspections that might be performed by a trained user. These inspections should include the following points:

- Log. During operation, the system performs a self-checking, creating a log with all the errors it finds. Periodic checking of the error log messages should be performed.
- LEDs. Inspect the proper operation of the different LEDs.
- Temperature. Check for abnormal temperature on the unit.
- Odor. Check no abnormal odor is present.
- Mechanical defects. Inspects the unit as having not present mechanical defects.
- Noise. Check for abnormal noises.
- Dirt. Clean with a dry cloth any dirt present on the unit.
- Cooling. Make sure the cooling system of the cabinet works properly.
- Communication. Check communications between the different components.
- Connections. Ensure all cable connections are properly tight to the terminal, and that the correspondent connector is well inserted in its socket. Ensure the Ethernet cable is well inserted into its RJ45 female connector.
- Attachment. Ensure the *Vigilant* is correctly attached to the mounting panel and does not move or have an excessive looseness.
- DIN rail. In case of DIN rail attachment ensures no oxidation, corrosion or dirt is present on both parts of the DIN rail assembly.
- Time configuration. Check for the correct time and date of the equipment.

### 14.3. Reboot

The *Reboot* function allows to restart the *Vigilant* quickly in case of error. To reboot the unit, follow these steps:

- Carefully insert a thin object (like a paper clip) into the hole located next to the power connector or, depending on your unit, press the button located next to the power connector
- Press and release the button located inside the hole.
- Wait until the unit is initialized.

#### 14.4. Rescue mode

If the button located in the hole next to the power connector is pressed while the *Vigilant* is starting up, the unit will enter the **rescue mode**.

Follow these steps to enter the **rescue mode**:

- Power off the *Vigilant*, if it is running, and wait until all LEDs are switched off.
- Carefully insert a thin object into the hole located next to the power connector or press the button instead and apply a slight pressure.
- Power on the *Vigilant* while holding the button down and wait until the status LED starts blinking red/orange. Then, release the button.

While in rescue mode, the same button can be used to execute several maintenance actions. The numbered LEDs will allow you to select which action to execute. Press and release quickly the button to change from one LED to another.

- Press and hold the button for two seconds or more to execute the selected action.

Actions in rescue mode:

LED	Action
1	Reboot
2	Reboot
3	Reboot
4	Delete the main configuration (inputs, sensors, machines...)
5	Delete all the users except "admin". Restore admin's password and preferences
6	Restore the system configuration (network, date, services...)
7	Delete all stored data (trends, spectra, waveforms...)
8	Delete <b>all configurations</b> and restore the <i>Vigilant</i> to its factory state

After an action is selected, the corresponding LED will turn yellow while the action is executed. When the process finishes, the LED will turn green again. Some actions could take up to one minute. After that, you can execute another action or reboot the system.

If an error occurs while executing an action, the corresponding LED will turn red.

#### 14.5. Micro-SD card maintenance

The *Vigilant* uses an internal micro-SD memory card for permanent storage of data. The device comes by default with a flash memory card with a total capacity of 4 Gb. Although **Vigilant** is using industrial range SD cards with pSLC technology for this feature, and that minimizes the risk of data loss or corruption, such data losses are ultimately unavoidable. The flash technologies used in micro-SD cards are subject to failure, and for several reasons it is possible that

some sectors of the card may become unreadable, or they cannot be written again, or they have other problems.

Since software version 0.7.0 this type of sporadic failures do not cause a general malfunction of the system, as the system is now to operate without flash memory, allows performing maintenance operations on it (for example, a formatting), or even replace the SD card if necessary.

The *Vigilant* allows three possibilities for permanent data storage:

- Use the internal micro-SD card for storage (default option).
- Storage disabled, by selecting this option from the Storage menu. Timeline function will be disabled in all the widgets, and the Trends widget will not work at all.
- Use temporary data storage. The data will be written only in the RAM memory and thus it will get lost as soon as the system is rebooted.



Temporary data storage option is activated automatically if any error is detected on the SD card during the system start-up.

If the system detects any type of anomaly in the reading or writing on the card, this event will be notified to the user by means of the Exception indicator in the navigation bar.

In the Storage menu, in System, it is possible to configure the equipment to work without storage, as well as to format the SD card in case it is not being used.

Using the Rescue mode at the start-up of the system it is also possible to perform some operations with the card, such as formatting it.

Otherwise, please contact **Vigilant** if you need to replace the SD card of your system or if you are not sure about its integrity. In following chapters, it is explained how to perform a Micro-SD card replacement .

## 14.6. Replacement of internal components

*Vigilant* has a removable cover on its back, from where you can access the inside of the equipment to proceed with the replacement operations of some elements that may have a limited useful life or may need to be replaced after a certain number of hours of use.

These elements are the following:

- Internal battery (for secondary power).
- Fan.
- Micro-SD card.

The following sections explain the replacement procedures for each of these elements.

This procedure refers exclusively to equipment with a hardware version equal or later than v1.3. That version was released to the public in July 2019. If your device is older than that, or you are not sure about it, please contact **Vigilant** to know how to handle the possible replacements.

### 14.6.1. Access to the rear compartment

The first step to replace any of the indicated elements is to access the rear compartment of the *Vigilant*.

- Disconnect your equipment from external power supplies and remove any wiring.

- Place the instrument on a horizontal surface that is clean and free of any possible element that could disturb your work.
- Verify that you have enough space to carry out the work.



To manipulate the instrument and access its interior it is recommended to use antistatic elements, such as an antistatic mat and bracelet.



To remove the screws and access the compartment you will need to use a screwdriver of the type PZ1 (Pozidriv). For the handling of the cables inside the compartment it is recommended to use a small flat screwdriver.

The first step to access the compartment is to remove the DIN rail clamp, using a screwdriver type PZ1, as shown in the following photo:



Once the DIN rail clamp is removed, remove the four screws at the corners of the back cover, as seen in the following photo:



Once the screws are removed, the back cover of the equipment may be carefully lifted. When removing the lid, you can see the internal compartment of the *Vigilant*:

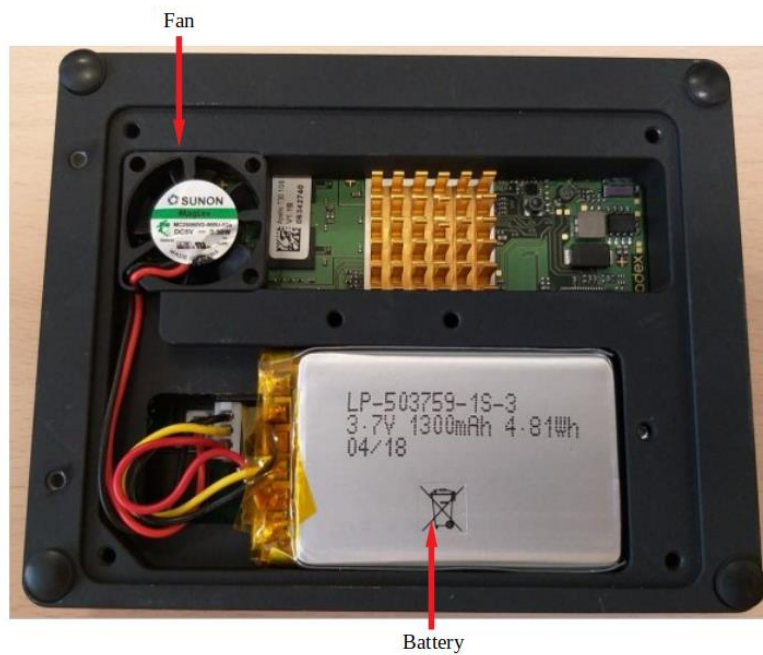

#### 14.6.2. Battery replacement

The Vigilant units carry an internal Lithium-Ion battery, which is used as an auxiliary power supply, which allows the clean shutdown of the operating system when the main power has been disconnected, allowing time to save the temporary data and index the bases of data.



Battery replacement is a safe procedure, safe from electrical hazards.



The battery cannot be replaced by any other model. Use only and exclusively batteries supplied by the equipment manufacturer.

The main body of the battery is simply embedded in the hole in the compartment. Remove the main body with your fingers or use a help tool if necessary. We recommend using a plastic tool such as those supplied to use with mobile phones. If you use a steel screwdriver, you may leave marks or aesthetically damage the equipment case.

The most delicate part of battery replacement is electrical disconnection. Be very careful when removing the connector and help yourself with the right tool. In no case pull the cables directly.

Note that the battery connector is polarized and only enters a certain position.

Be careful not to tangle the wires.

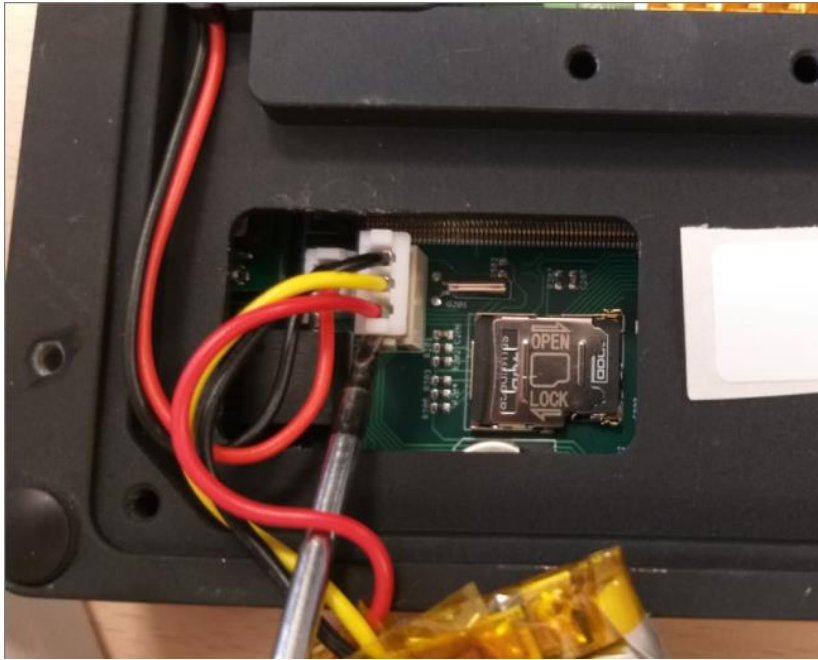

### 14.6.3. Fan replacement

The *Vigilant* units have a brushless fan unit that gets activated when the temperature inside the device exceeds 50 degrees Celsius. The fan helps control and stabilize the temperature of the system.



The fan replacement must only be carried out in exceptional cases in case a general fault of the installed unit has been determined. The manufacturer will supply the necessary replacement unit.

The fan replacement must only be carried out in exceptional cases in case a general fault of the installed unit has been determined. The manufacturer will supply the necessary replacement unit.

The fan used in the *Vigilant* has a life expectancy of more than 5 years working continuously at maximum power. Its replacement is an exceptional procedure and must be carried out with great care.

The procedure is remarkably like the one with the battery. Simply remove the main body of the fan with your fingers or with the help of a plastic tool that does not damage the equipment housing.

Remove the cable connector carefully, with the help of a tool, and never pull directly from the cables.

The connector is polarized and thus can only be inserted in one direction.



It is necessary to first remove the battery to have necessary space to remove the fan cables.

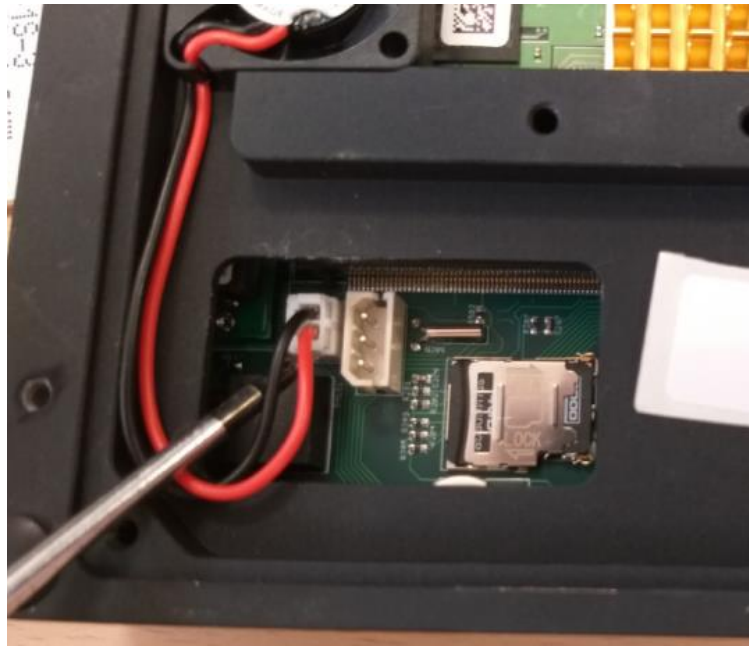

#### 14.6.4. Micro-SD card replacement

The *Vigilant* unit has an internal micro-SD card where all trend data, spectra, waveforms, etc. are permanently stored. The data is collected during normal operating measurements of the equipment. Other data such as measurement settings, system and users are also stored in the card.

Although the system has several hardware and software features intended to preserve the integrity of the storage system, storage units based on flash technology are fragile by nature. They all have relatively high failure rates.

Although most of the times faults affect unimportant blocks of data, eventually the main database of the system may get damaged, or even the boot partition of the card may get corrupted. In such events, it may become necessary or convenient to replace the micro-SD card.

*Vigilant* instruments are supplied with 4GB cards of industrial range (pSLC) formatted in FAT32. Although the system is supposed to be compatible with almost any microSD card format, it is recommended to contact **Vigilant** so that it can provide you with a suitable replacement for your card in case you need to change it.

In case the system detects an incorrect type of card or without the appropriate format, the device will start up with the storage deactivated. From the system menu or from the Recovery mode it is possible to carry out the initial formatting in principle of any micro-SD card.

To access the microSD card, you must first remove the battery from the computer. Once the battery is removed, the card's connection tray is in the accessible hole below it.

The tray shows two marks where you have to slide the cover of the same, one to open the compartment, and in the other direction to close it. You can slide this cover with the help of a screwdriver.



Once the compartment is opened, the card can be pulled up with the help of tweezers.



Card removal is a delicate procedure and for which a certain manual skill is required. Do not try to do it if you are not sure of the steps to follow and to have the right material.

### 14.7. Troubleshooting

The following table shows solutions for possible trouble with this device:

Symptom	Possible Cause	Description
No communication	The unit is off	Turn <i>Vigilant</i> on by applying power to it.
	Cabling	Ethernet port led's should be blinking in yellow. Otherwise check cable connections.



	Network configuration	Check network configuration. IP address and mask should be in the same range in both the <i>Vigilant</i> and the computer.
	Processor failure	Restart the unit.
The information is not displayed correctly	Bad functioning of the browser	Update the browser to the latest version. If this does not correct the problem, try a different web browser. The system is optimized to work with Chrome.
Incorrect value of the signals	Wrong wiring sensors	Check input LEDs (see <a href="#">Indicators</a> ). Check sensor wiring. Check <i>Vigilant</i> configuration.
Login website is not displayed	There are several sessions open	Delete browsing history in your web browser. Log out using the user menu in the top bar.
Power led is red	Wrong power supply	Check for the power supply, as specified in <a href="#">Power supply</a> .
	Firmware failure	Load new firmware to the unit. See <a href="#">Upgrading the firmware</a> .
	Hardware failure	Contact customer support.

## 15. Basic Operations

### 15.1. Starting Up the Unit

Connect the unit to the power supply as described in Power supply. Once the unit is powered, it will start up. The *Vigilant* has a start-up period of several seconds. This time can vary from 10 to 15 seconds.

The power led is used to indicate the status of the *Vigilant* during the start-up. During start-up, the status indicator will be turned on with a solid red color. After the start-up period the indicator turns into solid green, meaning the device start-up is completed successfully.

In case the power led keeps on red color that means the system presents a problem. See Troubleshooting.

### 15.2. Powering off the unit

Switch off the power supply or remove the power connector to shut down the system. The *Vigilant* includes a battery that will make the system to shut down properly.

When the *Vigilant* detects a loss in the power supply, it automatically initiates its shutdown. After it is down if power supply comes back the unit will start up again. In case the power supply comes back during the shutting down the process will continue until it is down, remaining in this condition for 1 minute. After that period, the unit will start up again.

### 15.3. Upgrading the firmware

This option is available in *System* interface, in the Upgrade firmware form:

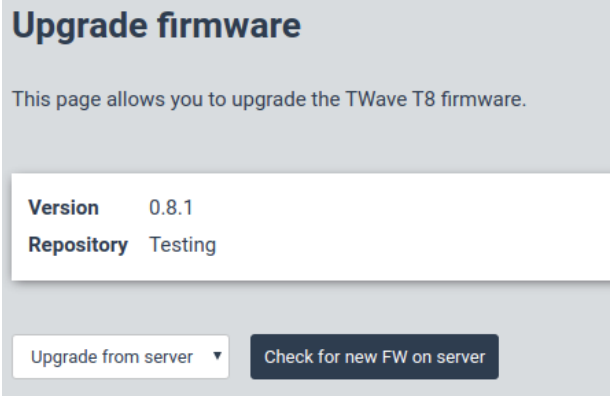

Moreover, the firmware can also be updated by selecting a file (download from our servers) in your network location. Otherwise, you will need direct connection to the Internet to execute the upgrade. The *Vigilant* must have access to the Internet and have necessary Network Ports open.



Online firmware upgrades require the *Vigilant* unit to have direct access to the Internet. It is therefore recommended to consider this requirement when defining the project and take actions for an easy way to connect the system to the Internet. It is also recommended when support by **Vigilant** is required. Required Network Ports must also be open.

Otherwise, the firmware can be downloaded at:

<http://ftp.sdt.be/pub/Products/VIGILANT/Vigilant/Firmware/>

Follow these steps to check for new versions and upgrading the firmware:

- 1) Upgrade from server: Click on *Check for new FW on server*. If a new firmware version is available, click on *Upgrade* to begin with the installation.
- 2) Offline upgrade: After selecting a file from your computer or your local network, the system will check if it is a valid firmware file, and if its version is newer than the one currently active in the device. If it is valid, the installation will begin.
- 3) In order not to damage the unit it is particularly important to follow the indications. The process of updating can take up to several minutes.
- 4) The unit will be automatically restarted after upgrading the firmware.



It is strongly recommended not to interrupt the uploading and installation process of the firmware. This process can take several minutes, so the unit must not be reset or turned off.



It is strongly recommended not to interrupt the uploading and installation process of the firmware. This process can take several minutes, so the unit must not be reset or turned off.

It is strongly recommended to delete the cache of the web navigator after system upgrade. Some navigators will not load some parts of the interface, but they will use the stored interface instead, and this could lead to some troubles with the system.

## 15.4. Using RSync and FTP for system backups

VIGILANT has two file transfer services active by default, RSync and FTP, which can be used to back-up the system. To run the backup, simply copy the system files and store them on the user's local computer, and later restore them to a VIGILANT unit, either the same or a different one. It is important to know which important files need to be copied and then restored. These are listed below:

- config: folder with the different configuration databases (system.db, users.db and conf.db) and backup files
- data: folder with all the stored data and alarm database and snapshot indexes
- images: folder with the images uploaded to the device
- sim\_files: simulation files uploaded to the device



Transferring or copying files must be done in binary format. Copying in ASCII mode causes corruption and loss of data.

## 16. Appendix A

### 16.1. Creating simulation files

Simulation files are raw (header-less) binary files with 16-bit signed integer samples recorded at 51200 Hz. You can create new simulation files using an audio editor.

In the following instructions we will make a 440 Hz sine tone using the free audio editing software [Audacity](#). Adjust default sample rate and sample format: **Edit > Preferences > Quality**. Set the default sample rate to **51200 Hz** and sample format to **16-bit**.

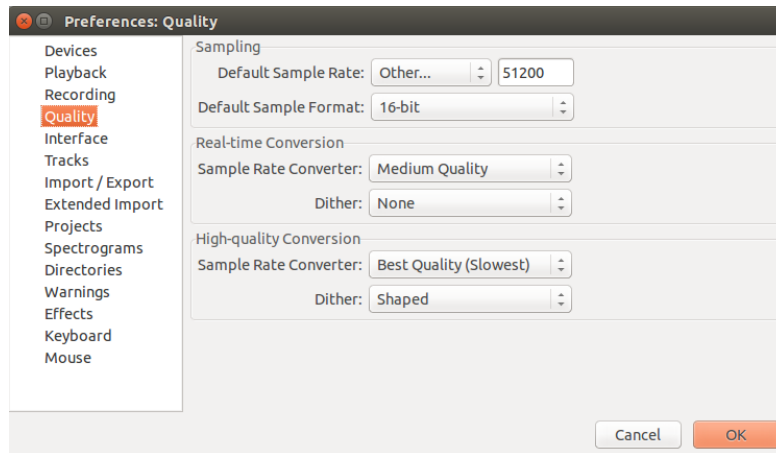

Create a 440 Hz, 30 seconds long sine tone: **Generate > Tone**.

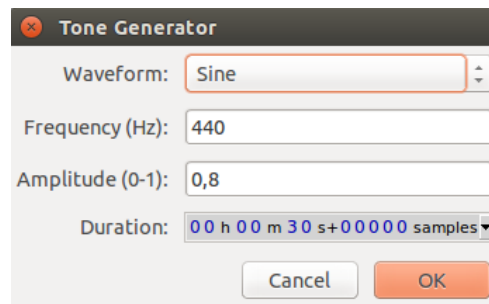

Export file as raw file (header-less) 16-bit signed integer samples: **File > Export > Other uncompressed files**. Set header to **RAW** and encoding to **signed 16-bit PCM**.

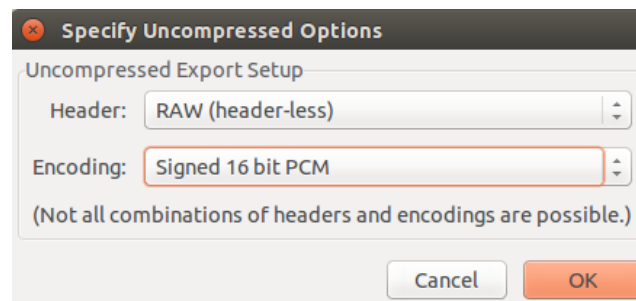

## 17. Appendix B

### 17.1. Optional Licenses

*Vigilant* has a wide variety of optional modules and utilities that allow the customization of the system to meet any particular requirement.

The system may also be adapted to any specific needs, upon request, so customers only pay for the functions to be used.

Code	Feature	Included	Optional	Description
ET	Extend Processing Blocks	X		Extend to 24 simultaneous processing blocks
WV	Waveform Widget	X		Displays the original dynamic sensor data
SP	Spectrum Widget	X		Displays the FFT data transformation
DM	Demodulation	X		Technique for detecting HF bearing failures
OB	Orbits & SCL widgets		X	Enables Shaft Centerline and Orbit widgets
AC	Advanced Capture		X	Allow advanced event-based storage strategies
LW	Long Waveforms	x		Capture and storage of long duration waveforms
PH	Phase Tools		x	Calculation and display of phase displacements
SW	Spectrum Waterfall	x		Shows multiple spectra in a 3-D plot
MB	Modbus Master	x		Allows using ModBus for external readings
OP	OPC UA Client	x		Allows using OPC for external readings
EM	Custom email server	x		Allows using customized email servers
FO	Offline firmware upgrade	x		Upgrade firmware using a local file

Optional features may be activated for any of the predefined configurations.

## 18. Appendix C

### 18.1. Network Ports

#### 18.1.1. Incoming connections

Port	Service	Description
TCP 80	HTTP	Web server
TCP 443	HTTPS	Web server (SSL support)
TCP 21	FTP	FTP server for data backup
TCP 873	RSYNC	Rysnc server for data backup
TCP 502	MODBUS TCP	Modbus TCP slave
TCP 22	SSH	Reserved for remote support and maintenance

#### 18.1.2. Outgoing connections

Port	Service	Destination	Description
UDP 123	NTP	Configurable by the user	Automatic system clock synchronization
TCP 502	MODBUS TCP	Configurable by the user	MODBUS TCP master
TCP 443	HTTPS	feeds.bevigilant.io	Firmware updates
TCP 465	SMTP	mail.bevigilant.io	Allows sending notification emails to users (optional)

## 19. Appendix D

### 19.1. Keyboard Shortcuts

Key	Action
<b>General</b>	
escape	Close modal window (one level).
h	Show this panel.
l	Show alarm log.
o	Open or close the sidebar.
<b>Desktop</b>	
ctrl + d	Add a new desktop.
d	Select the next desktop (in cycle).
e	Enter layout editor.
shift + d	Select previous desktop (in cycle).
shift + tab	Focus previous widget (in cycle).
tab	Focus next widget (in cycle).
<b>Layout Editor</b>	
escape	Exit layout editor.
r	Move the desktop tab to the right.
shift + r	Move the desktop tab to the left.
<b>Forms</b>	
arrowdown	Move form select list down.
arrowup	Move form select list up.
enter	Accept form.
escape	Cancel form.
shift + tab	Focus on the previous form element.
space	Toggle checkbox or select option.
tab	Focus on the next form element.
<b>Any Widget</b>	
c	Open widget configuration.
delete	Delete widget.
i	Open or close widget info panel.
Space	Maximize or minimize widget.

<b>Spectrum</b>	
arrowleft*	Move active cursor one sample left.
arrowright*	Move active cursor one sample right.
Arrowup	Find an approximated peak with respect to the cursor.
Enter	Start or stop data streaming.
f*	Move active cursor 1/10 sample left.
g*	Move active cursor 1/10 sample right.
j*	Move active timeline cursor one event left.
k*	Move active timeline cursor one event right.
N	Change to the next cursor (in cycle).
P	Change to next processing mode (in cycle).
shift + arrowleft*	Move all cursors one sample left.
shift + arrowright*	Move all cursors one sample right.
shift + f*	Move all cursors 1/10 sample left.
shift + g*	Move all cursors 1/10 sample right.
t	Open or close timeline.
x	Exit cursor mode.
w	Show waveform.
z	Reset zoom.
<b>Waveform</b>	
arrowleft*	Move active cursor one sample left.
arrowright*	Move active cursor one sample right.
enter	Start or stop data streaming.
f*	Move active cursor 1/10 sample left.
g*	Move active cursor 1/10 sample right.
j*	Move active timeline cursor one event left.
k*	Move active timeline cursor one event right.
n	Change to the next cursor (in cycle).
p	Change to next processing mode (in cycle).
s	Show spectrum.
shift + arrowleft*	Move all cursors one sample left.
shift + arrowright*	Move all cursors one sample right.
shift + f*	Move all cursors 1/10 sample left.



shift + g*	Move all cursors 1/10 sample right.
t	Open or close timeline.
x	Exit cursor mode.
z	Reset zoom.
<b>Parameters</b>	
enter	Start or stop data streaming.
j*	Move active timeline cursor one event left.
k*	Move active timeline cursor one event right.
t	Open or close timeline.
<b>Trend</b>	
arrowdown	Change focus to the next source (in cycle).
arrowleft*	Move active cursor one sample left.
arrowright*	Move active cursor one sample right.
Arrowup	Change focus to previous source (in cycle).
shift + arrowleft*	Move all cursors one sample left.
shift + arrowright*	Move all cursors one sample right.
Z	Reset zoom.
<b>Orbit</b>	
arrowleft*	Move active cursor one sample left.
arrowright*	Move active cursor one sample right.
Enter	Start or stop data streaming.
j*	Move active timeline cursor one event left.
k*	Move active timeline cursor one event right.
T	Open or close timeline.
Z	Reset zoom.
<b>Phase Diagram</b>	
arrowleft*	Move active cursor one sample left.
arrowright*	Move active cursor one sample right.
t	Open or close timeline.
z	Reset zoom.
<b>Long Waveform</b>	
j*	Move active timeline cursor one event left.
k*	Move active timeline cursor one event right.

t	Open or close timeline.
<b>Waterfall</b>	
Arrow down	Move down one layer.
arrowleft*	Move active cursor one sample left.
arrowright*	Move active cursor one sample right.
arrowup	Move up one layer.
P	Change to next processing mode (in cycle).
S	Show spectrum.
T	Open or close timeline.
<b>Shaft Centerline</b>	
arrowleft*	Move active cursor one sample left.
arrowright*	Move active cursor one sample right.
x	Exit cursor mode.
z	Reset zoom.

(\*) Holding the key repeats the shortcut.

	CMA 13/10/2022	Revised version	CGI
	CGI 2021/05/12	Updated version + layout	RGO
	CMA 2021/04/26	Updated version/Product certifications	RGO
	CGI	Original version	CMA
	<b>Editor</b>	<b>Nature of modification</b>	<b>erified</b>