



Ultrasound Solutions

Sherlog Master Kit

SDT270 receiver and SDT 8 MS transmitter

Technical and User's instruction manual

You can download the latest version of this manual by visiting the SDT International website: www.sdtultrasound.com



Copyright © 2014 by SDT International n.v. s.a., October 2014.

All rights reserved: No one is permitted to reproduce or duplicate, in any form, the whole or part of this document without the written permission of SDT International n.v. s.a.

The information herein is believed to be accurate to the best of our knowledge.

Due to continued research and development, specifications of this product can change without prior notice.

In this manual, *SDT International n.v. s.a.* is named SDT.

SDT International n.v. s.a.

Bd. de l'Humanité 415,

B – 1190 Brussels (BELGIUM)

Tel: ++32.2.332.32.25

Fax: ++32.2.376.27.07

e-mail: info@sdtultrasound.com

web page: www.sdtultrasound.com

Table of contents

First and foremost.....	6
1 Foreword.....	7
1.1 Purpose of the manual.....	7
1.2 Operator safety.....	7
1.3 End of life destruction of the equipment.....	7
2 Description of the Sherlog Kit Master.....	8
3 Certificates	9
3.1 Class Type Approval	9
3.2 The calibration certificate	9
3.3 The certificate of qualification.....	9
3.4 The certificate of origin	9
The SDT270 receiver.....	10
4 SDT270 receiver.....	11
4.1 Operating principle of the SDT270.....	11
4.1.1 General.....	11
4.1.2 Applying ultrasonic waves on the Sherlog.....	11
4.1.3 SDT270 receiver features	11
4.1.4 Updating possibilities	11
4.2 The keyboard.....	12
4.3 The display.....	13
4.3.1 Startup / PowerDown screen	13
4.3.2 Measurement screen	14
4.3.3 Type of sensor used.....	15
4.3.4 Date / Battery autonomy / Time.....	15
4.3.5 The measured data and its additional information.....	15
4.4 The front view.....	16
4.5 The rear view	17
4.6 Charging the battery	17
4.7 The battery autonomy	18
5 Icons overview	19
5.1 Menu icons	19
5.2 Information icons.....	20
5.3 Function key icons	21
6 The Sherlog main Menu	22
6.1 Access to the main menu	22
6.2 The Sherlog main menu screen	22
7 Settings Menu	24
7.1 Access to the functions	24
7.2 Using the Settings menu	24
7.2.1 Set the device language	24
7.2.2 Set Date and Time.....	24
7.2.3 LCD settings	24
7.2.4 Set the Auto Power Down time	25
7.2.5 Network settings.....	25
7.2.6 Factory Restore.....	25
8 System Info Menu	26

9	Start new survey Menu	26
9.1	Access to the functions	26
9.2	Using the start new survey menu	26
10	Browse survey / resume Menu.....	27
10.1	Access to the functions	27
10.2	Using the browse survey / resume menu	27
10.2.1	Browse survey data.....	27
10.2.2	Resume a survey.....	28
The SDT8 MS transmitter		29
11	SDT 8 MS transmitter	30
11.1	Package	30
11.2	Presentation	30
11.3	SDT 8 MS transmitter description.....	31
12	Using the multi-setting transmitter	32
12.1	Recommendations	32
12.2	Working position	32
12.3	Powering On.....	32
12.4	Setting the transmitting power	33
12.5	Measurements.....	33
12.6	Powering Off.....	33
13	Charging the SDT 8 MS transmitter battery pack.....	33
14	The multi-transmitter operational problems.....	35
14.1	Ultrasonic transducer.....	35
14.2	Control fuse	35
Using the SDT270 receiver for an ultrasonic hatch cover tightness test		36
15	The Class required hatch cover ultrasonic tightness test	37
15.1	Checking the date and time.....	37
15.2	Positioning the SDT 8 MS transmitter	37
15.3	Starting a survey procedure	37
15.3.1	Entering the survey information data	37
15.3.2	Carrying out an on-site functional test	38
15.3.3	Selecting the hold number, the hatch number and the bow direction	39
15.3.4	Storing the Open Hatch Value	39
15.3.5	Storing a measurement.....	40
15.3.6	Storing the Open Hatch End Value	42
15.4	Ending / Interrupting / resuming a survey	43
15.5	Adding a new operator	44
The Sherlog report software		45
16	Using the report software	46
16.1	Installation of the software	46
16.2	Connecting the device.....	47
16.3	Downloading the data.....	47
16.4	Erasing the data	49
Technical specifications.....		50
17	SDT270 receiver.....	51
17.1	Measurement instrument	51
17.2	Internal ultrasonic sensor.....	51
17.3	Flexible sensor	52
17.4	Battery charger	52
18	SDT 8 MS transmitter	53
18.1	Transmission characteristics.....	53
18.2	Supply.....	53

18.3	On / Off switch.....	53
18.4	Others.....	53
Appendixes		54
19	SDT270 Declaration of conformity in the European Union	55
20	SDT 8 MS Declaration of conformity in the European Union	56
21	Copies of certificates	57
22	Warranty and responsibility limits	60
22.1	Warranty	60
22.1.1	Guarantee.....	60
22.1.2	Limitation of liability	60
22.2	Responsibility limits	60

First and foremost

1 Foreword

1.1 Purpose of the manual

This User's Manual is designed as an educational guide and reference tool for anyone who wishes to use the *Sherlog Kit Master* for its intended purposes. Inside you will find information pertaining to:

- The description and functionality of the equipment.
- Its many uses.
- How to care for and maintain the equipment.

Recommendations relative to the declaration of compliance to the European Community's regulations, the guarantee and the different areas of application are included into this User's Manual.

SDT produces this User's Manual with the sole purpose of supplying simple and accurate information to the user. **SDT** shall not be held responsible for any misinterpretation of this User's Manual. Despite our efforts to provide an accurate manual, it may contain technical errors. If in doubt, contact your local **SDT** distributor for clarification. While every effort was made to present a true and accurate text, modifications and/or improvements to the product described herein can be made at any time without corresponding changes being made to this User's Manual.

Please read this User's Manual carefully, and file it in a safe place for future reference. All requests and warnings of this User's Manual must be followed in order to maximize the value of your investment. This User's Manual and its contents remain the inalienable property of SDT. The information herein is believed to be accurate to the best of our knowledge.

All rights reserved. No one is permitted to reproduce or duplicate, in any form, the whole or part of this document without the written permission of **SDT**.

1.2 Operator safety

The operator must take all necessary precautions when using the equipment in high risk areas (under high noise levels, high light and radiation levels, extreme temperature conditions, chemical corrosive elements, etc.).

The user must be particularly vigilant when entering enclosed zones (holds, silos) where a risk of asphyxiation or lack of oxygen is possible. There is no likelihood of direct consequences for the hearing capacities of the operator.

The instrument **MAY NOT** be used inside any classified zone requiring explosion proof equipment. When required to make measurements in areas where an explosive atmosphere might exist, operators should be aware of the fact that the SDT 270 receiver and the SDT 8 MS transmitter are not intrinsically safe. However, and for use in explosive atmospheres, SDT has developed the SDT 270 Ex-proof version but same is not covered by the present manual.

1.3 End of life destruction of the equipment

When the equipment becomes obsolete, the internal battery pack must be removed from the equipment, and must be disposed of in such a way that conforms to the environmental laws of the country where the equipment is located.

The outer casing and other internal components may be destroyed by the appropriate specialized organizations.

The mandatory stipulations of applicable law take precedence over the contents of this User's Manual.

2 Description of the Sherlog Kit Master

The complete Sherlog Kit Master which contains:

SDT270 receiver assembly

- 1 x SDT270 receiver with rubber protection.
- 1 x Battery loader for SDT270 receiver.
- 1 x Flexible sensor 820 mm for SDT270 receiver (tube + flex).
- 1 x extension accessories for SDT270 receiver (threaded tip and rubber tip).
- 1 x Headphones, noise isolating.
- 1 x Y plug connector for headphones.
- 1 x USB flash drive for data transfer from SDT270 receiver to PC.
- 1 x Cable USB Length 1.5 m.

SDT 8 MS transmitter

- 1 x SDT 8 MS transmitter, multi-setting, with battery.
- 1 x Leather case for SDT 8 MS.
- 1 x Spare battery pack for SDT 8 MS.
- 1 x Battery loader for SDT 8 MS.
- 1 x Battery loader adapter for SDT 8 MS.
- 1 x Screw driver for the SDT 8 MS battery cover.

Others

- 1 x Technical and instruction manual.
- 1 x Calibration certificate.
- A copy of the current type approval certificates can be found on our website www.sdtultrasound.com

3 Certificates

3.1 Class Type Approval

According to IACS UR-Z17, the ultrasonic tightness testing equipment used by Class Service Suppliers for testing the weathertight integrity of hatch covers should be class type approved.

Like its predecessor – the SDT Sherlog TA – both the Sherlog Kit Cadet (with SDT200 receiver) and Sherlog Kit Master (with SDT270 receiver) have been developed in order to meet with Class criteria for Type Approval. Both equipments have the necessary features on board to comply with, and exceed, Class type approval requirements. The high quality of SDT equipment reassures ship owners and their managers that their ships have been inspected with state of the art equipment that meets with the highest industry standards.

3.2 The calibration certificate

SDT recommends annual recalibration of SDT instruments and sensors. This periodicity is coherent with the observed long-term stability of SDT electronic equipment's.

However

- The first SDT certificate is valid for a period of 15 months (to avoid penalizing a customer receiving an instrument that stayed in stock for 3 months).
- SDT recognizes that each customer may have their own Quality Assurance Standards and internal requirements. If a customer has established a Quality Assurance Program that includes a documented procedure for measurement deviations, and if an instrument and the relevant sensor show acceptable deviations and do not show signs of physical damage, then calibration periodicity could be extended to two years.
- Third party organizations having more authority (Class, or State Administrations) may have defined their own regulations for example 6 months, or 2 years calibration interval: by evidence, local legally applicable regulations supersede SDT rules.

For these reasons, SDT Calibration Certificates do no more mention a “calibration due date”, but simply the “last calibration date”.

For user convenience, the date of the last calibration of an SDT200 or 270 instruments can also be found in the menu screens.

Note: This text refers to SDT document DC.QUAL.005¹

3.3 The certificate of qualification

A certificate of qualification is obtained after having successfully passed the theoretical and practical on- board training program. The validity of the certificate is limited to three years. A copy of the Calibration Certificate is available in the Appendixes section.

3.4 The certificate of origin

The certificate of origin can be supplied on demand

¹ This document is part of SDT ISO-9001 certified quality management system

The SDT270 receiver

4 SDT270 receiver

4.1 Operating principle of the SDT270

4.1.1 General

Ultrasonic waves are sound waves beyond the range of human hearing (>20 kHz). To be detected, we need to use an instrument like the SDT270, with the capability to receive ultrasonic frequencies and convert them to corresponding audible sounds.

Ultrasonic waves travel through gases (air), liquids (water, fuel) and solids (bearing housings) in a very directional nature; unlike audible sounds which disperse in all directions. Ultrasounds are low energy sound waves, therefore they are quickly absorbed by the medium through which they travel. Ultrasonic waves are generated by:

- Naturally occurring mechanical phenomena (friction of rotating equipment), pressure or vacuum leaks (pneumatic, gas, steam) or arcing and corona (electrical problems).
- Artificially by means of a transmitter (like the *SDT 200 mW* or the *SDT 8 MS - 8 x 125 mW*) for tightness testing.

4.1.2 Applying ultrasonic waves on the Sherlog

The *SDT270* detects ultrasonic signals, converts them to audible frequencies, and amplifies them. The challenge is to transpose the received signal, using the heterodyne technology, into an interpretable audible signal. This solution extends the ability of the human ear beyond the simple audible range and into the ultrasonic one.

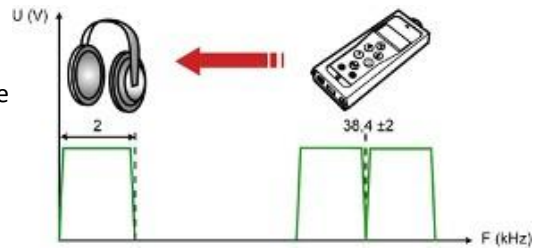

The main function of the SDT270 is converting high frequency signals into audible.

4.1.3 SDT270 receiver features

The SDT270 receiver provides:

- Data storage
- Tamper-proof hatch cover survey routine software with data logging and data transfer to PC.
- Transfer software on USB flash drive (1).
- Sensor connector for ultrasonic and non- ultrasonic external.
- Build in tachometer and temperature sensor (2)

- (1) Through the connector for PC.
- (2) Only active after obtaining the required key from SDT.

4.1.4 Updating possibilities

Regularly and for different reasons, the software version from the SDT270 receiver will be updated, the most common reason being a technical improvement in the core software.

This makes the SDT270 receiver the only Ultrasonic Multifunctional receiver in the world that is always up to date.

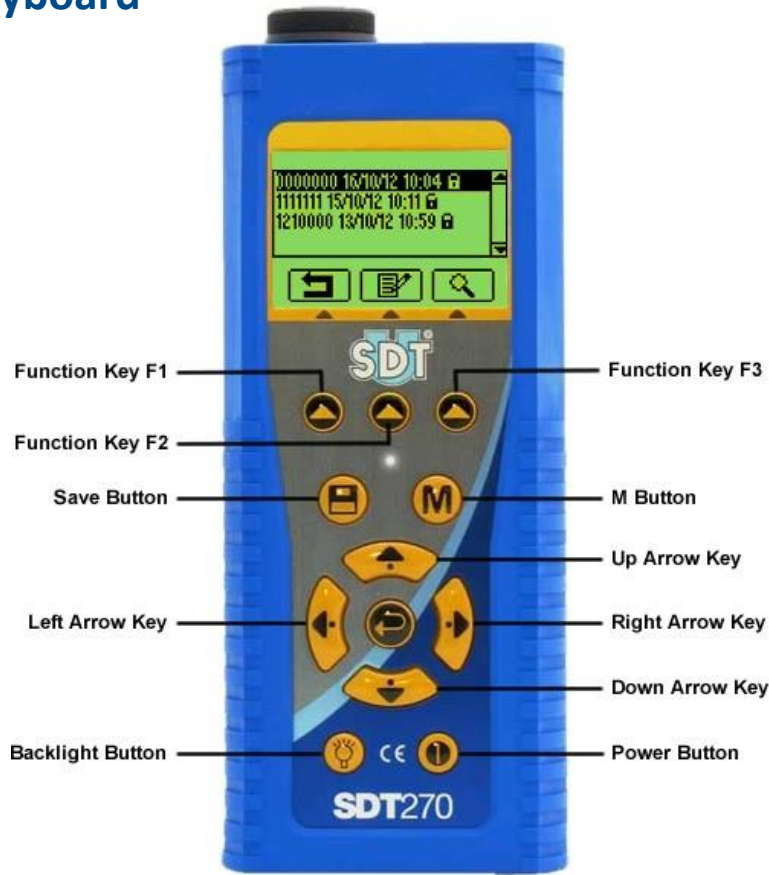

Every owner of a SDT270 receiver can download this software update. The only things needed are a cable, an Internet connection and an unzip software.

4.2 The keyboard



The keys correspond to the following functions:

Key	Function	Remarks
	Function keys	Function of the key is related to the displayed symbol or text above (on LCD screen). There are 3 function keys provided which are referred to as "F1" – "F2" – "F3".
	Save	Stores the measurement data.
	Freeze/Measure Start recording	Freezes the displayed value or take measurement in static mode Only used when measuring ultrasound and noise levels (dBμV) in dynamic mode.
	Navigation keys	Moving the cursor up and down within menus.
	Increase / reduce amplification level Scroll up and down through menus and sub-menus	The A on screen is modified (measurement screens).
	In- / Decrement alphanumeric digits	Used during the text entering procedure or to set date, etc.
	Navigation keys	Moving the cursor left and right.
	Move the cursor to another field	Used during the text entering procedure to jump to another field, etc.
	In- / Decrement output volume	

	Enter.	Used to validate and confirm a shown selection.
	Activate backlighting.	Press the key to switch on the backlight Pressing the key again switches off the backlight. The backlighting switches off automatically if no buttons are used within a pre-defined period of time set by the user. To set this pre-defined period, the operator has to access the "Settings" menu.
	On/Off switch.	First key press: switch on the unit. Second key press: switch off the unit. The unit switches off automatically if no buttons are touched on the keypad within pre-defined period of time set by the user.

The function keys

The function of a function key is related to the displayed symbol or text above (on LCD screen). There are 3 function keys provided which are referred to as "F1" – "F2" – "F3".

Escape Button

Function key F1 is considered as the general escape key. If no icons or text are shown on the screen, press function key F1 to return to the previous menu.

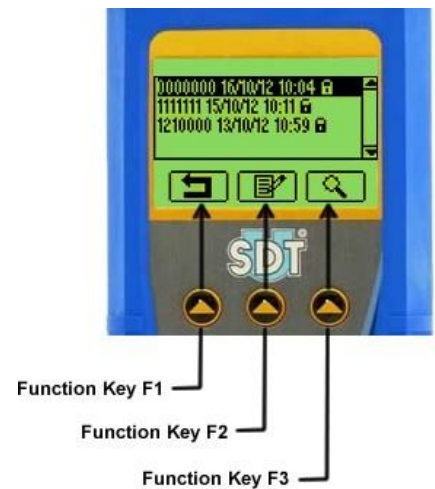

4.3 The display

4.3.1 Startup / PowerDown screen

At startup, depending on the selected working mode, one of the following screens is displayed.



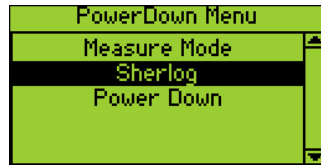

Icon menu



Text menu

To switch between text and icon menus, see 7.2.3 LCD settings .

Icon menu	Text menu	Function
	Power Down	Power down the device.
	Sherlog Mode	Enter the Sherlog mode of the device. (used for hatch cover tightness testing survey)
	Measure Mode	Enter the Measurement mode (used for predictive maintenance applications)

For more detailed information on all different menus, see:

- Chapter 6 : The Sherlog main Menu
- Chapter 7 : Settings Menu
- Chapter 8 : System Info Menu
- Chapter 9 : Start new survey Menu
- Chapter 10 : Browse survey / resume Menu
- Chapter 15 : The Class required hatch cover ultrasonic tightness test

4.3.2 Measurement screen

The following table summarizes the visible information areas within the measurement screens.

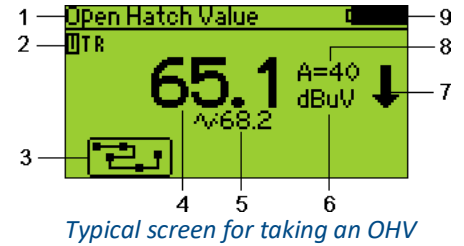

N°	Function	Remarks
1	Selected sensor	Display alternates between selected sensor and hold/hatch number.
2	Selected Input	<u>Top row:</u> U : Internal US sensor T : Internal Temperature sensor R : Internal RPM sensor <u>Bottom row:</u> B : Black external input connector R : Red external input connector
3	Function menu icon / text	Icon or text related to the function key below.
4	Measured value	The measured value after pressing the M-button. This value will be stored by using the Save-button.
5	Current value	The continuous measured value. This value gives an indication of the actual measured ultrasounds.
6	Unit of measurement	Display of the measurement unit of the selected sensor (dBμV, T°, RPM, etc.).
7	Amplification indicator	Indicates if the amplification level is to be increased or decreased in order to obtain a correct measurement
8	Amplification level	A = selected amplification level.
9	Information	Display alternates between time, date and battery level indicator (a 100% black battery corresponds to a fully charged battery).

4.3.3 Type of sensor used

The selected input (rep. 1) is displayed at the upper left corner of the display. The system auto recognizes externally connected sensors (rep. 2) and switches automatically to the corresponding measurement unit.

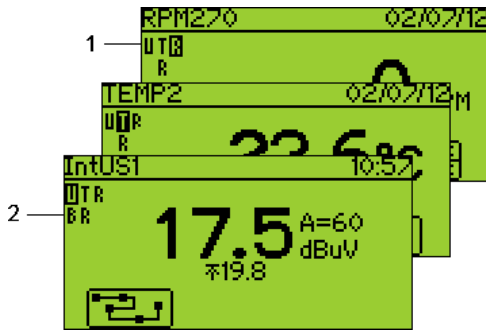

- 1 - Top row:
 U : Internal US sensor
 T : Internal Temperature sensor
 R : Internal RMP sensor
- 2 - Bottom row:
 B : Black external input connector
 R : Red external input connector

Primary icon locations on the display of the SDT270 receiver

4.3.4 Date / Battery autonomy / Time

These functions/info only shows up when you have started a survey.

This information (rep. 1) is cycling on the upper right corner of the screen.

The remaining capacity in the battery is expressed by an icon (the amount of blackening corresponds to the remaining capacity of the battery). The following table shows the icons used.

Icon	Signification
1. 02/07/12	Date in the specified format.
2. 12:23	Time in the specified format.
3.	Estimated remaining capacity of the battery. A 100 % black icon indicates a fully charged battery.

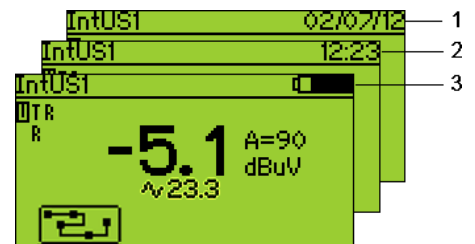

Example of revolving information

4.3.5 The measured data and its additional information

The display shows the measured data and its additional information described in the lower paragraphs, which are:

- Measured value.
- Measurement unit.
- Selected amplification level.
- Up and down arrows when a change of the amplification level is required.

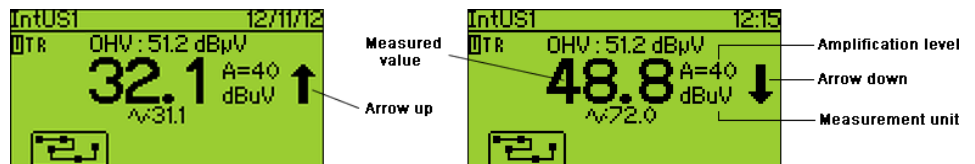

The main information relating to the measurement

The measured value

The measured value is shown in the middle of the screen. This value can be refreshed by pressing repeatedly on the M-button. The measurement is stored by pressing the save-button. Stored measurements can be recalled at any time. (See chapter 10.2 Using the browse survey / resume menu)

The measurement unit

The measurement unit is shown on the right side of the display, such as **dBuV** when the equipment is used in US / Sherlog Mode.

The amplification level

This function is only activated when an analog (ultrasound) sensor is connected. The internal US sensor and the flex sensor are both analog sensors.

The amplification level **A** varies on a scale from **10** to **90** dB.

Due to logarithmic characteristics, each and every time the **A** level is increased (decreased) by **10** (next or previous step), the gain is multiplied (divided) by approximately 3.

For example:

- **A** = 40 -> Gain = 100.
- **A** = 50 -> Gain = 300.

Understandably, when the ultrasonic level is high, little amplification is needed. When the ultrasonic level is very low (small leaks), the amplification required will be high.

When, in presence of a source of ultrasounds, the SDT270 receiver must be adjusted to an optimal **A**level. The SDT270 receiver assists you on the screen by means of the **↑** and **↓** arrows at the right side of the screen. The adjustment of the optimal **A**level is obtained by pressing **↑** to increase or by pressing **↓** to decrease.

- **↑** indicates that the amplification level is too low and that a higher amplification level should be selected.
- **↓** indicates that the amplification level is too high and that a lower amplification level should be selected.

The equipment is ready to take a correct measurement when the amplification indicator disappears from the screen. Whenever the amplification value is not properly adjusted, the SDT270 will not make a correct measurement.

If the amplification is set to low a 0-reading will be shown on the display whilst the amplification indicator will be pointing upwards **↑**

If the amplification is set to high an inaccurate-reading will be shown on the display whilst the amplification indicator will be pointing downwards **↓**



Last but not least, it must also be understood that the amplification level determines the **minimal** dB μ V measurement that the SDT270 receiver will consider for a set level. For example, at **A = 40**, the instrument will display all measurements above 29 dB μ V and will **not** display sounds lower than 29 dB μ V.

The table below indicates the correlation between the different amplification levels, the gain and the correspondent minimal sound level in dB μ V.

A	10	20	30	40	50	60	70	80	90
Gain	3	10	30	100	300	1000	3000	10 000	30 000
Min (1)	59	49	39	29	19	9	-0.4	-7	-7.5

For the above mentioned reasons, one now understand why when measuring an Open Hatch Value (OHV), the SDT270 receiver detects an important ultrasonic output volume generated by the multi-transmitter, which requires an adjustment of the optimal amplification level.

But when one is seeking for minor to very small leaks, the amplification level **must** be set at the max. level, i.e. 90 in order to detect even the smallest leaks. The scale above shows that at those **A**levels, the SDT270 receiver will display values of minimal **-7.5** dB μ V. No leak can then remain undetected.

4.4 The front view

The internal sensors

- | | |
|-------------------------------------|----------------------------------|
| 1. Built-in tachometer (optional). | 4. Internal US sensor. |
| 2. Laser. | 5. Lemo connector (Black collar) |
| 3. Built-in thermometer (optional). | 6. Lemo connector (Red collar) |



Front view of the SDT270 receiver

The receiver has an internal sensor (4) for detecting airborne ultrasounds and other ultrasonic phenomena such as compressed air leaks, vacuum leaks and corona discharge. It is directly connected to the internal components and protected by the sturdy extruded aluminum housing. In addition it also has a built-in tachometer (1) and a built-in thermometer (3), activation of which is optional and not included in the standard sherlog key (an additional key needs to be purchased to activate both options)

This internal sensor is not waterproof. Precautions must be taken to protect the sensor from humidity and projections of liquids. For that purpose, the internal sensor is protected by a metal cap, which has to be fitted if the sensor is not in use.

Lemo connector for external sensors

These are used to connect external sensors. When an external sensor is plugged in, the device automatically selects the corresponding input.

The type of lemo connector selected by the operator is displayed in the bottom row of the selected inputs as “R” (red connector) or “B” (black connector)

4.5 The rear view

This figure represents the location of the connectors at the rear plate.

- | | |
|--------------------------------|----------------------------|
| 1. Access to the reset button. | 4. Network connector. |
| 2. Mini USB connector. | 5. Battery loader connecto |
| 3. Headphones connector. | |



Rear view of the SDT270 receiver

Reset button

The reset button forces an immediate shutdown and restart of the SDT270 receiver. Perform this reset for troubleshooting and resolving problems with an unresponsive SDT270 receiver.

Mini USB connector

Used to connect the SDT270 to your computer via the provided mini USB/USB cable. This is used to download measurements to a PC. This port is also used to update new software to the SDT270 receiver.

The headphones set connector

The supplied headphones are connected to the SDT270 receiver in order to listen to the converted ultrasounds. The Y plug is used to connect a second set of headphones.

The network connector

Allows an Ethernet connection to the device. This connection gives the same functionalities than the USB connection but ensures a faster communication.

The battery charger connector

This 3-pin connector is used to make the connection with the battery charger provided with the SDT270 receiver. Due to the active interaction between the charger and the battery/equipment, only this charger can be used to charge the batteries.



Connecting another charger may cause serious damage to the equipment and void the warranty.

4.6 Charging the battery

None of this high powered technology is going to work if the battery is flat, so let's deal with that first. If you have just taken your SDT270 and this manual out of the box for the first time, please put your device on charge now.

The SDT270 uses an internal NiMH battery. The battery charger outlet will connect to a socket on the rear side of the device.



Connecting another charger may cause serious damage to the equipment and void the warranty.

The charging time will typically be 6 hours. When the Led of the charger is off, the SDT270 battery is completely charged.

Like most batteries these days, leaving the SDT270 charging after the charger says it is charged does not hurt the battery – in fact it very slowly tops the charge up a little more. During the charging process, a status led on the charger will be blinking. For more info on the charger status see 17.4 Battery charger.

You can charge the SDT270 receiver switched off. You can also trickle charge the SDT270 receiver switched on, so you can be using it to load and unload data, for example, and charge it at the same time.

4.7 The battery autonomy

A fully charged battery will give you about 8 hours of continuous use. This will vary of course depending upon your need to use the backlight and the power drain of certain external sensors that you might be using.



You can increase the autonomy by more than 20% by disabling the LAN. (see 0 Connecting the device on a computer network)
You are also able to set an Auto Power Down and a time before switching off the backlight. (see 7.2.4 Set the Auto Power Down)

5 Icons overview



The device has two navigation options.



- Navigation based on text menu's
- Navigation based on icons (for unsupported device languages)

See 7.2.3 LCD menu to switch between **Text** and **Icons**







The SDT270 receiver can be used for two applications: Tightness testing of hatch covers (Sherlog mode) and On board predictive maintenance applications. For predictive maintenance applications, please consult the SDT270 SB, SS, SD, SU, DD, or DU user manuals (depending of you SDT270 version)

5.1 Menu icons

Power up / down menu



Icon menu	Text menu	Function
	Power Down	Power down the device.
	Sherlog Mode	Enter the Sherlog mode of the device. (used for hatch cover tightness testing survey)
	Measure Mode	Enter the Measurement mode (used for predictive maintenance applications)

Settings menu





Icon menu	Text menu	Function
	Return	Return to the previous screen.
	Language	Set the device language.
	Time/Date	Set Date and Time
	Lcd	Set LCD parameters and switch between text and icon menus.
	Auto Power Down	Set Auto Power Down time
	Network	Network settings.
	Factory Restore	Restore to the factory defaults. This function does not erase any stored data.

Signal menu (only in Measure Mode)





Icon menu	Text menu	Function
	Dynamic	Enter the Dynamic measurement mode.

	Static	Enter the Static measurement mode.
	Variable Mixer	Enter the Variable Mixer mode.







Sherlog main menu (only in Sherlog Mode)

Icon menu	Text menu	Function
	Settings	Enter the Settings menu.
	System Info	Displays the system information.
	Start new survey	Start a new Hatch Cover Test survey.
	Browse survey / resume	<ul style="list-style-type: none"> • Browse and display completed surveys. • Resume surveys.

















Survey menu (only in Sherlog Mode)

Icon menu	Text menu	Function
	Return	Return to the previous screen.
	Go To Hold Hatch	Continue the survey to the next hold / hatch.
	View Survey Data	Display the current survey data.
	End survey	End the survey.

5.2 Information icons



Icon	Description
	Operator information.
	Certificate information.
	Date and time information.
	Ship information.
	Port Information.
	Hold and Hatch information

5.3 Function key icons

Icon	Description
	Back (return to the previous screen)
	Skip (go to next screen)
	Switch between sensors (Internal and External sensors)
	Switch between Static / Dynamic / Variable Mixer measurement mode.
	Display and/or set sensor options.
	Save options.
	Undo all changes.
	Put laser on.
	Put laser off.
	Increase value.
	Decrease value.
	Activate editing mode.
	Activate displaying mode (allows to see survey data, no editing allowed)
	Delete.
	Erase a character
	Ok / Continue

6 The Sherlog main Menu

6.1 Access to the main menu

- Switch on the equipment by pressing the  key.
- Once the equipment switched on, the self-test is started. If no problem or fault is detected during this test, a startup screen (Power Down Menu) is shown.
- Select  / **Sherlog** to access the Sherlog mode.
- The Sherlog main menu screen is displayed as follows.

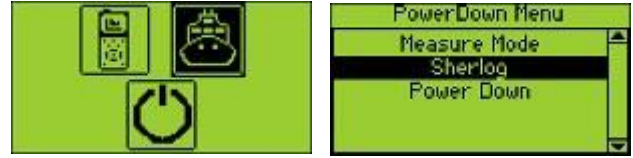

The startup menu (icon mode and text mode).



The SDT270 main menu (icon mode and text mode).

6.2 The Sherlog main menu screen





Presentation

When the startup screen is shown, select  / **Sherlog** to access the Sherlog Main menu.







The SDT270 main menu (icon mode and text mode).

The active keys are:

Key	Function
	Scroll up and down through menus and sub-menus
	
	Enter, validates the choice (the inverted line).
	Activate backlighting. This key is available at any time.
	.On/Off switch. This key is available at any time.

The Sherlog main menu

Icon menu	Text menu	Function
	Settings	<p>Use this menu to select :</p> <ul style="list-style-type: none"> • 'Language': change device interface language (English, Nederlands, Français, Deutsch, Italiano or Español). • 'Time/Date': set date, time and their format. • 'Lcd': adjust the screen contrast and the operating time of the backlight • 'Auto Power Down': adjust the time before device auto power down when it is unused. • 'Network': set network settings. • 'Factory Restore': force a factory reset of the SDT270 device. Note that this does not erase saved measurements.
	System Info	<p>Displays the device information as follows:</p> <ul style="list-style-type: none"> • Licence information (screen 1) • Calibration information (screen 2) • Battery information (screen 3) • Hardware information (screen 4) • Database info (screen 5) <p>Use the <i>Up and down arrow buttons</i> to switch between the different screens. Push the <i>F1 button</i> to go back to the Sherlog menu.</p>
	Start new survey	Start a new hatch cover survey procedure.
	Browse survey / resume	<p>Browse through previously completed surveys or the survey which is still in progress.</p> <ul style="list-style-type: none"> • The data of the survey in progress can be viewed and/or edited. • The data of finished surveys can be viewed and not edited anymore.

7 Settings Menu

7.1 Access to the functions

From the Sherlog Main menu, select  / **Settings**.

The settings menu screen is displayed as follows.



The settings menu (icon mode and text mode).

Leave the **Settings** menu to go back to the Sherlog menu by selecting  / **Return** and press the “Enter” button
-or-
Press function key F1.

7.2 Using the Settings menu

Use the **Settings** menu to modify the general device parameters.

7.2.1 Set the device language

From the **Settings** menu, select  / **Language** and confirm your choice by pressing the enter button.



The available languages are: English, Dutch, French, German, Italian and Spanish.

Leave this menu by pressing the F1 escape button.

7.2.2 Set Date and Time

From the **Settings** menu, select  / **Time/Date**.

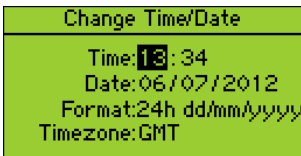

Enter the local Date and Time. Changing the time zone will change the date and time setting. Use the up or down arrow buttons to resp. increase/decrease. Confirm your choice by pressing the enter button.

To move from time to date – format – time zone, press the left or right buttons.

Leave this menu by pressing the F1 escape button.

The available date and time formats are:

- 24h yyyy/mm/dd
- 24h mm/dd/yyyy
- 24h dd/mm/yyyy
- 12h yyyy/mm/dd
- 12h mm/dd/yyyy
- 12h dd/mm/yyyy

The default time setting is in GMT, but can be adjusted as well by using the up and down arrow keys.

7.2.3 LCD settings

From the **Settings** menu, select  / **Lcd**

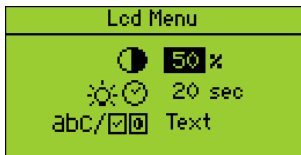

 This parameter modifies the screen displays contrast ratio. The default value is 50%.

 This parameter adjusts the time before the instrument switches off the backlight. It is an energy saver for the battery.

The range of the timer is adjustable between 1 and 100 seconds. The default is set to 20 seconds.

   Switch between icons and text menus .

To move from one setting to another, press the left or right buttons.

Leave this menu by pressing the F1 escape button.

7.2.4 Set the Auto Power Down time

From the **Settings** menu, select  / **Auto Power Down**

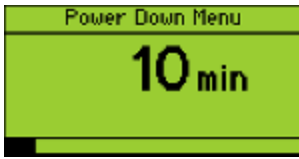

This function sets the time for the instrument to switch off power automatically to save the battery power. This function is activated when the instrument is not in use and that no key is hit during the pre-programmed time. The timer is adjustable between 1 and 100 minutes. The default is set to 10 minutes. Use up and down arrow keys to change the value. Use the left arrow key to set the value to zero and so deactivate the auto power down.

Leave this menu by pressing the F1 escape button.

7.2.5 Network settings

From the **Settings** menu, select  / **Network**

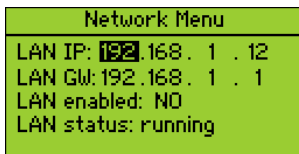

Enter the IP address and Default gateway. Your system administrator and/or the network administrator will have this information.

(See 0 Connecting the device on a computer network)

Leave this menu by pressing the F1 escape button.



When your device is not connected to a Network, it is advised to parameter the LAN to disable. This setting permits to increase the battery autonomy of more than 20%. Use the **Right Arrow** to highlight the **LAN enabled** field, then using the **Up Arrow** set the field to **NO**.

7.2.6 Factory Restore

From the **Settings** menu, select  / **Factory Restore**

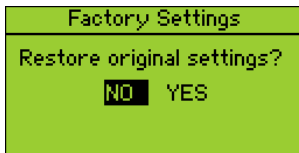

This function force a factory reset of the device. Note that this does not erase saved measurements.

Leave this menu by pressing the F1 escape button.

8 System Info Menu

From the Main menu, select  / **System Info**.

The device information is displayed on five screens. Use the *Up and down arrow buttons* to switch between the different screens. Push the *F1 button* to go back to the main menu and push once again the *F1 button* to go back to the measurements screen.

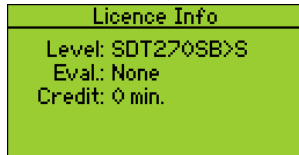

Licence information

The level and the enabled options depend on the device key. Additional information on all possible levels, options and available licenses can be found on our website wsdtultrasound.com

→ Press the “**Arrow Down**” key.

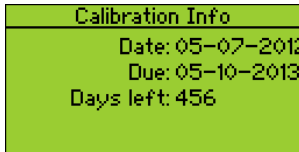

Calibration Info

Shows the last calibration date, the due date and the remaining days before your device needs to be recalibrated.

→ Press the “**Arrow Down**” key.

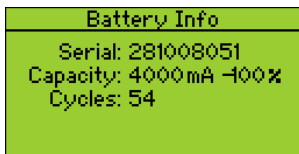

Battery Information

Shows the serial number of the battery pack and the battery capacity when it is fully loaded.

→ Press the “**Arrow Down**” key.

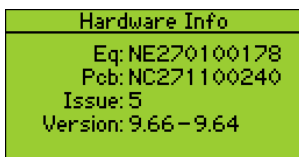

Hardware Information

Shows the equipment number, the PCB number and the version of the device.

Leave these information screens by pressing the F1 escape button.

9 Start new survey Menu

This function allows to start a new hatch cover (HCO) survey

9.1 Access to the functions

Select  / **Start new survey** from the Sherlog menu.

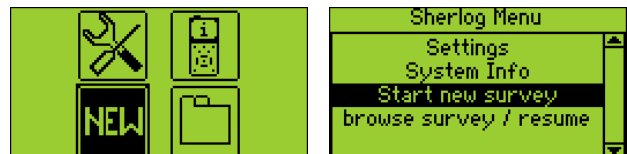

The “Start new survey” menu (icon mode and text mode).

9.2 Using the start new survey menu

Entering the **Start new survey** menu activates the procedure to start a new “Hatch cover tightness survey”

See chapter 15 The Class required hatch cover ultrasonic tightness (“Approval program for service suppliers performing tightness testing of hatches with ultrasonic equipment on ships, high speed and light craft and mobile offshore units”)

10 Browse survey / resume Menu

This function allows browsing previously completed hatch cover (HCO) surveys and resuming surveys which are in progress. This screen is accessible at any time even during a survey and allows to check recorded data for a given ship number and date, during or after a survey session.

- As long as a survey is not finished (End survey), new hold/hatch data can be added.
- Survey data of unfinished surveys **cannot** be modified anymore.
- Unfinished surveys cannot be downloaded.

10.1 Access to the functions

Select  / **browse survey / resume** from the Sherlog Menu.

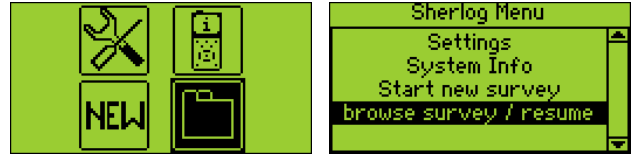

The "Browse survey / resume" menu (icon mode and text mode).

10.2 Using the browse survey / resume menu

The **browse survey / resume** menu opens an ordered list of all taken surveys.





The surveys are ordered by date descending.

Use up and down arrow keys to navigate through the list.



No existing data can be deleted or changed. Only an in-progress "hatch cover test procedure" can be completed or a new hatch test section can be added.

Icon	Function
	Function key F1 → Returns to the main menu.
	Function key F2 → Resume the selected survey.
	Function key F3 → Display and browse through the selected survey data.

Once you are in a survey, pushing on F1 does not allow you to go back to browse menu, you have to push the power off button, re-enter the sherlog mode and then enter the browse menu.

10.2.1 Browse survey data

Once the survey has been selected, press function key F3 () to display the survey data.

A survey can contain data of one or more holds. These holds are accessed by one or more hatches and these hatches are covered with one or more hatch cover panels. Data is collected and displayed per hatch cover.

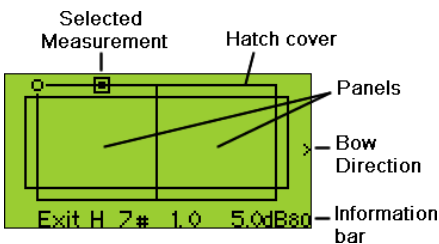

The screen shows a graphical image of the hatch with the specified number of panels, the bow direction and a measurement information bar.

The stored measurements are displayed with various symbols.

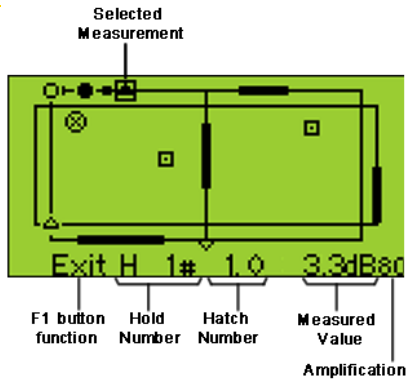

Symbol	Function
○	Open hatch Start measurement
●	Open hatch End measurement
■	Spot leak
▮	Linear leak
△	Drain
⊗	Ventilator
⊠	Loading port

The position of the symbol in the drawing is a reference to the location of the item and it's measurement on the hatch.

The information bar at the bottom of the screen gives more details about the selected measurement:

- Hold number
- Hatch number (sub-hatch number)
- Measured value
- Used Amplification

When a hatch is too large to be tested at one time, it can be virtually divided into 2 or 3 equal parts/volumes. For every hatch part, the hatch cover test procedure is followed (this means that every part is to be considered as a new hold/hatch and that the complete procedure as for a new hatch has to be followed)

The active keys are:

Key	Function
	Scroll up and down through all holds and hatches of the survey.
	Scroll through all the measurements on the screen.
	Function key F1 → Exit the browse screen menu.

10.2.2 Resume a survey

Once the survey which is still in progress has been selected from the list of surveys, press function key F2 () to resume the survey.

No existing data can be deleted or changed. Only an in-progress "hatch cover test" (illustrated by an "open" padlock) can be completed or a new hatch can be selected and added.

When all hatches of a survey have an open hatch end value, and this survey is selected to resume, the screen automatically adds a new hold +1 (from #3 you will then see #4)

The SDT8 MS transmitter

11 SDT 8 MS transmitter

This section is directed to anyone who needs to use an ultrasonic transmitter for tightness inspections (e.g. hatch covers, water tight doors, ramp covers, windows, bulkhead openings, etc.). The SDT 8 MS transmitter is to be operated in combination with the SDT270 receiver, but can also be used with the Sherlog Kit Cadet and the Sherlog Kit Mate (see www.sdtultrasound.com). This section contains information on how to operate the equipment, how to solve and overcome problems and the characteristics of the equipment.

11.1 Package

The SDT 8 MS transmitter and its related components are included in the Sherlog Kit Master:

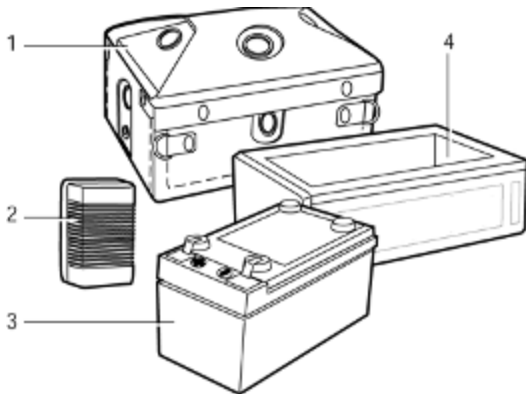

1. Multi-setting transmitter, a leather bag and a shoulder strap
2. 220 V - 0.3 Ah charger
3. Two sealed lead-acid gel 12V - 1.2 Ah batteries
4. Adapter for battery charging and screwdriver (not shown).

The multi-transmitter with its main dedicated components.

11.2 Presentation

The box-shaped multi-transmitter (160 x 100 x 95 mm) is operated with a sealed lead-acid gel battery and weighs 1500 grams. The battery allows the transmitter to be used in temperatures ranging from -20 °C to +50 °C.

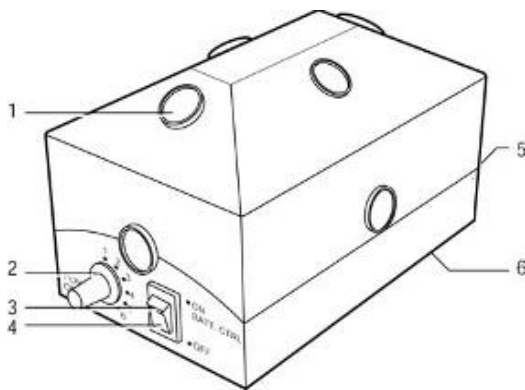

1. Ultrasonic transducer.
2. Six position potentiometer (1 = minimal ultrasonic power).
3. Red light on/off indicator.
4. ON-OFF switch.
5. On-Off switch.
6. Battery (underneath at the bottom).

General view of the multi-transmitter.

The ultrasonic transducers

Eight transducers (1) are laid out in the equipment in such a way that they transmit in the volume of a hemisphere. Each ultrasonic transducer has a power of 125 mW and is frequency and power stabilized. The ultrasonic transmission frequency is 39.2 and 39.6 kHz (bi-sonic mode).

The red light indicator

A red light indicator (3), integrated in the On/Off switch, shows whether the equipment is switched on as well as whether the battery is still charged. Refer to paragraph 13.1 *Recharging the battery* for further information.

11.3 SDT 8 MS transmitter description

The on-off switch

Located at the base, this switch (3) enables the equipment to be switched on (ON position) or off (OFF position).

The 6 position multi-setting potentiometer

It regulates the total output power of the ultrasonic signal; level 1 provides the minimum level and 6 the maximum.

The charge connector

Marked LOAD, the charge connector enables to re-load the internal battery without removing it. Overcharging is not possible when used with the SDT charger provided. Batteries can be charged during use. (Batteries will charge slower when the equipment is in use)

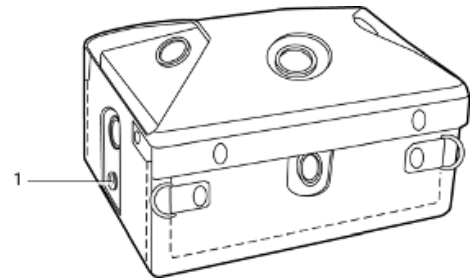

The charge connector is located on the side of the multi-transmitter.

The battery

The sealed lead-acid gel type battery is accessible after having removed the bottom protection plate. The rated voltage is 12V and its capacity is 1.2Ah at 20 °C; the autonomy is 2.5 to 3.5 hour for a full charge. The position of the battery in its compartment is of no importance from a polarity point of view.

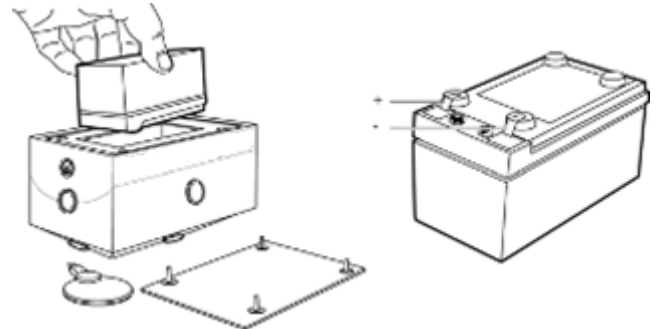

The battery is accessible from the bottom

The multi-transmitter serial number

It is located at the bottom, on the removable plate.

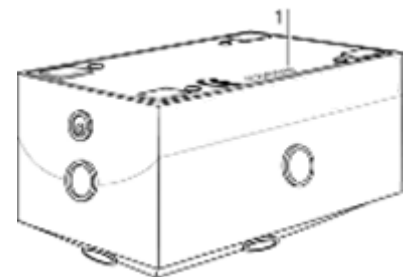

Localization of the serial number of the multi-transmitter.

12 Using the multi-setting transmitter

12.1 Recommendations

The multi-transmitter must be used:

- In combination with a *SDT270* receiver;
- Outside any classified zone requiring intrinsic and fireproof safety.
- Away from discharge of water and must never be immersed. It is important to prevent any foreign bodies entering the ultrasonic transducers, such as grease, dust, etc.
- Within hygrometric and temperature limits stipulated in the technical characteristics.

Note: If necessary, the transmitter can be protected / covered by thin / fine mesh cloth (e.g. nylon stockings) to prevent dust from entering into the transducers when working in a dusty atmosphere.

12.2 Working position

When preparing for testing the weathertightness of hatch covers and determining the OHV (Open Hatch Value), the multi-transmitter should be placed, ideally, in the center of the tank top.

The multi-transmitter covers an operational spherical volume of 20 meters (60 ft) around its position. For larger volumes, the multi-transmitter should be moved several times; it is then necessary to take a new OHV (Open Hatch Value) measurement after having repositioned the transmitter.

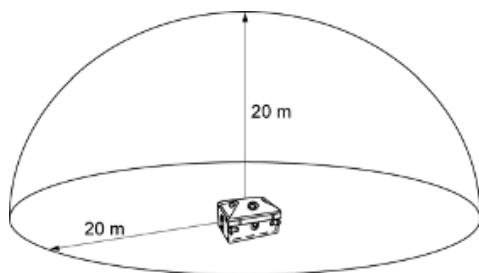

The volume covered by one multi-transmitter.

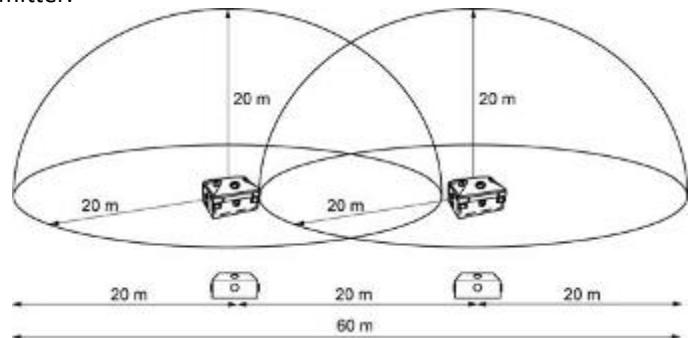

The zone covered by the multi-transmitter when set to various points.

If the hold is not empty, the multi-transmitter can be placed on top of the cargo.

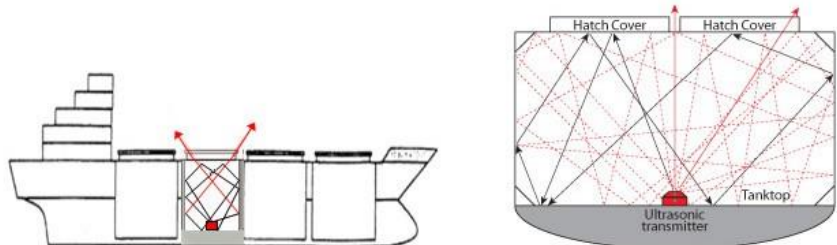

The correct position of the multi-transmitter.

12.3 Powering On

Note: The battery packs are charged in our factory for test purpose but the battery packs are discharged before being dispatched, because of international air transport legislation. Upon reception, the battery packs should be charged.

The equipment is powered on by pushing the switch to the ON position (1). The operating light (2) should be lit (if this is not the case then refer to chapter 14 The multi-transmitter operational problems).

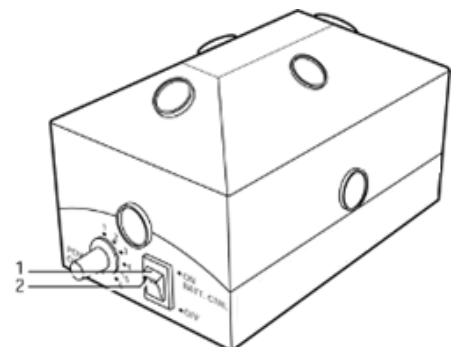

The on-off switch (1) and battery control indicator (2).

12.4 Setting the transmitting power

When testing the tightness of volumes/holds, set the multi-setting selector according to the volume of the space to be tested.

For larger volumes/holds, the selector should normally be set on position 6. For smaller holds/volumes the selector may have to be set to a lower position.

12.5 Measurements

The 8 transducers of the multi-transmitter work in the bi-sonic mode on frequencies stabilized at 39.2 and 39.6 kHz, with total transmission power also stabilized at 8 x 125 mW. The measurements will be carried out by the SDT270 receiver (see chapter 15 for the use of the equipment).

12.6 Powering Off

To power off the transmitter, set the switch to the Off position (1). The red operating status light should switch off.

13 Charging the SDT 8 MS transmitter battery pack

The battery packs are charged in our factory for test purposes but the battery packs are discharged before being dispatched, because of international air transport regulations. Upon reception, the battery packs should be recharged.

Recommendations

The battery is a sealed lead-acid gel battery. Therefore:

- Short circuit of the contacts is dangerous.
- The battery must not be discarded onto a flame.
- Recharging in a sealed box is prohibited (gas leaks).
- All mechanical shocks able to break the box may adversely affect the life of the battery.
- In the case of electrolyte coming into contact with the skin, rinse the contaminated area immediately with water.
- Recharge an unused battery pack every three (3) weeks.

Generalities on charging

Charging will be carried out:

- Either to maintain the charge of the battery. A continuous charge is not harmful to the life of the battery, as long as the charger provided with the multi-transmitter is used.
- Or after the flashing of the indicator of the battery.

The following table details the state of battery charge in relation to the information provided by the indicator:

Power switch	Indicator light	Transmitter
On	Continuous	- Transmitter is switched on. - Battery charge is correct.
On	Flashing	- Transmitter is switched on. - Battery charge is incorrect. - The speed of the flashing increases as the charge decreases.
On	Off (no light)	Insufficient charge, or no battery.
Off		Transmitter is switched off.

Without removing the battery

Proceed as follows:

- Before every recharging operation, unplug the battery charger from the mains and re-plug it, in order to reset the internal timer.
- Connect the plug to the socket marked LOAD on the multi-transmitter.
- Connect the charger to the mains.
- Leave it on charge for 6 hours for a completely flat battery. There is no maximum charge indicator.

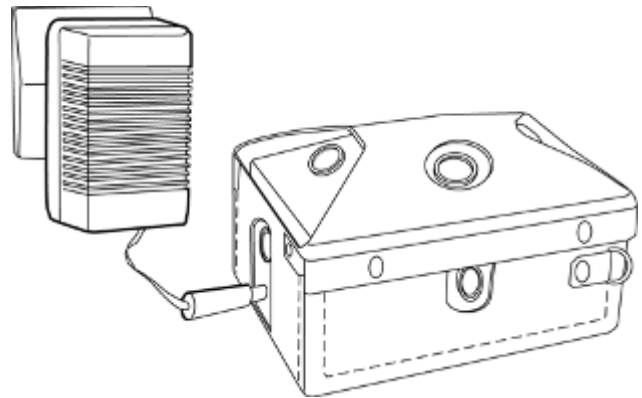

*Recharging a battery via the transmitter
(without removing it).*

When removing the battery

Proceed as follows:

- Remove the lid at the base of the multi-transmitter by means of the screwdriver provided with the SDT Sherlog Kit Master and remove the battery.
Before every recharging operation, unplug the battery charger from the mains and re-plug it, in order to reset the internal timer.
- Connect the plug to the battery's support socket.
- Place the battery in the support (contacts inside). There is no preferential direction for the battery.
- Leave the battery on charge for 6 hours for a completely flat battery. There is no indicator for a maximum charge.
- Batteries should be discharged from time to time to avoid build-up effect.

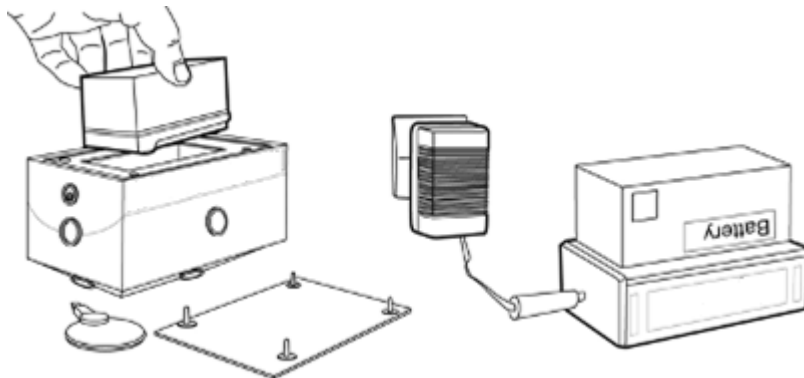

Removing the battery and charging same with the provided support.

14 The multi-transmitter operational problems

14.1 Ultrasonic transducer

Decreasing ultrasonic signal

The main reason, when an unstable signal is read/displayed on the SDT270 receiver, is that the battery is not fully charged. The discharge curve of the battery is constant over a long period. Any variation in power will immediately stop the transmitter in order to prevent incorrect measurements.

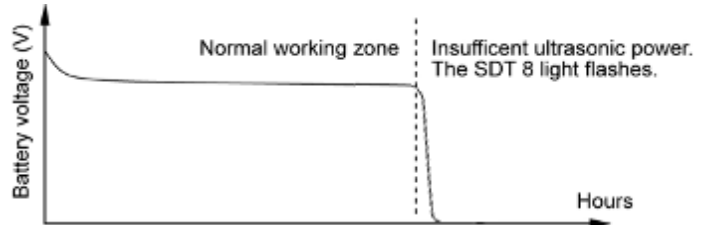

Curve illustrating a decreasing ultrasonic signal.

Low but constant level ultrasonic signal

If the signal measured from a transducer during the function test (when the Amplification level is set at 10 and the transmitter selector switch position in position 1) is significantly lower than 95 dB μ V and however remains constant, this indicates that the functioning of the transducer is impaired by some clogging/damage. In this case, clean the transducer(s) or protective grid. Do not use compressed air to clean/blow out any impurities.

Defective transducers

Transducers may become damaged due to:

- A mechanical shock/impact: return the equipment to your distributor in order to change one or more transducers as necessary.
- Water in the transducers: leave to dry and check that there is no water left, etc.
- Dust, debris and grease: try to clean gently, do not use compressed air to clean/blow out any impurities.

Above damages/problems will reduce the transmission power significantly which may result in incorrect measurements so that corrective action is required.

Note: The failure of one or two transducers will not prevent you from carrying out a correct tightness test. The remaining total output will still be sufficient in most cases.

14.2 Control fuse

If, despite an apparently correctly charged battery, the transmitter (whilst in good working order), does not produce any ultrasonic signal, a chemical control fuse located in the internal electronics as well as in the battery support unit may have been triggered.

Contrary to a standard type fuse, such a fuse contains a progressive reset time corresponding to the following curve. In this case, wait 1 to 5 minutes and try again.

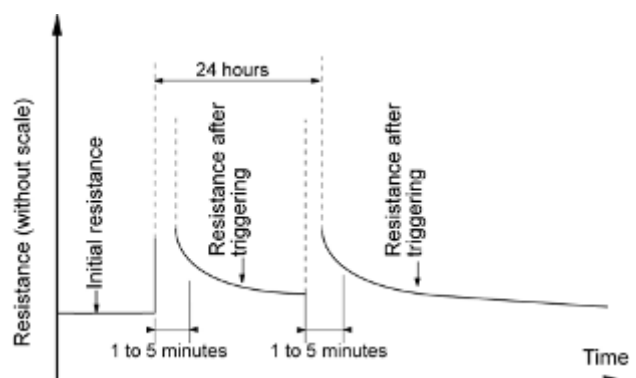

Automatic reset curve of the chemical fuse.



Never replace the chemical fuse with a different type. Successive occurrences of triggering are caused by a failure in the equipment. It is therefore advisable to return the equipment to the distributor for repairs.













Using the SDT270 receiver for an ultrasonic hatch cover tightness test

*Complies with the DNV Approval Program n°403,
survey procedure approved by IACS in July 1997*

15 The Class required hatch cover ultrasonic tightness test

This chapter describes a complete survey procedure.

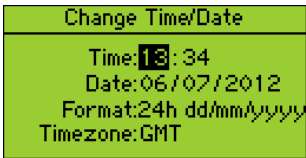
15.1 Checking the date and time

Step	Screen (Icon / Text mode)	Key	Action
1			Switch on the SDT270 receiver
2			Enter the <i>Sherlog</i> Mode: <ul style="list-style-type: none"> • Select  / Sherlog • Press the enter key.
3			Enter the settings menu <ul style="list-style-type: none"> • Select  / Settings • Press the enter key.
4			Enter the date and time settings. <ul style="list-style-type: none"> • Select  / Time/Date • Press the enter key.
5		 	Check and/or set date and time to the local date and time (LT) <ul style="list-style-type: none"> • Use arrow up and down keys to change to values • Use arrow left and right keys to move to the next position. • Press enter key to confirm and leave this screen.

15.2 Positioning the SDT 8 MS transmitter







The multi-transmitter should be placed according to paragraph 12.2 Working position.











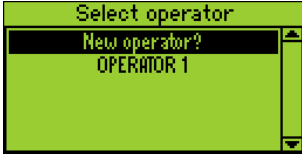













15.3 Starting a survey procedure

Note: Prior to starting a new survey, ensure that all settings are adjusted to the specific survey and personal requirements.

15.3.1 Entering the survey information data

Proceed as follows:





Step	Screen (Icon / Text mode)	Key	Action
1			Switch on the SDT270 receiver
2			Enter the <i>Sherlog</i> Mode: <ul style="list-style-type: none"> • Select  / Sherlog • Press the enter key.
3			Start a new hatch cover test procedure: <ul style="list-style-type: none"> • Select  / Start new survey • Press the enter key.

Step	Screen (Icon / Text mode)	Key	Action
4		  	Select an operator: <ul style="list-style-type: none"> • Use arrow up / down keys to select an operator. • Press the enter key. To add a new operator, see 15.3.5 Adding a new operator.
5			Confirm operator certificate details by pressing the enter key. <ul style="list-style-type: none"> • Press function key F1 () to go back to the previous screen. • Press function key F2 () to edit the certificate data. • Press function key F3 () to delete the operator (only possible when there are no surveys linked to the selected operator)
6		 	Enter the local time and date by using the arrow keys. <ul style="list-style-type: none"> • Press the enter button to confirm the displayed date and time. • Press function key F2 () to edit the local date and time. • Press function key F1 () to go back to the previous screen.
7		 	Enter the ship's IMO number and its name by using the arrow keys. <ul style="list-style-type: none"> • Press the enter button to confirm IMO number and name. • Press function key F1 () to go back to the previous screen. • Press function key F2 () to delete a character.
8		 	Enter the port name by using the arrow keys. <ul style="list-style-type: none"> • Press the enter key to confirm. • Press function key F1 () to go back to the previous screen. • Press function key F2 () to delete a character.

15.3.2 Carrying out an on-site functional test

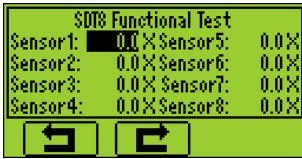
It is mandatory to proceed to an on-site test in order to check the full functionalities of the measuring chain (multi-transmitter, receiver, headphones and external sensor).

Proceed as follows:

Step	Screen	Key	Action
9			Bring the sensor close to any of the eight transducers and measure (by pressing the enter key) the dBµV value, which should not be lower than 95 dBµV. Values lower than 70 dBµV won't be displayed. Move up and down (using the arrow keys) to redo a test of a particular sensor. <ul style="list-style-type: none"> • Press function key F1 () to go back to the previous screen. • Press function key F2 () to skip the test.







If the emitted signal of one of the transducers is lower than 95 dBµV:

- The transducer has a failure.
- Possible presence of dust, debris or grease in the transducer.
- The battery is unloaded.

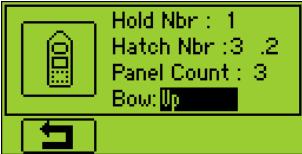
In order to carry out the functional test – put the multi-transmitter selector switch on position 1. When, after measuring, the “X” symbol appears on the screen, this means that there is a problem with the transducer in question. When the “V” symbol is displayed, press enter and continue with the next transducer. When all transducers are checked and in order, press the enter key to continue with the survey. In case there are one or more sensors which are not functioning properly, but the operators decides to continue the test regardless, press the F2 button to allow you to skip the functional test and continue with the survey. Remember that the details of the functional test will be reproduced on the download.

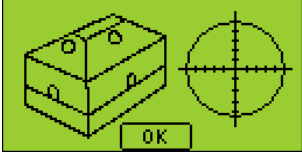
15.3.3 Selecting the hold number, the hatch number and the bow direction

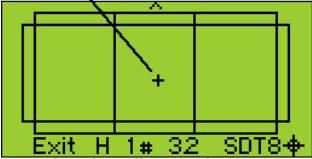
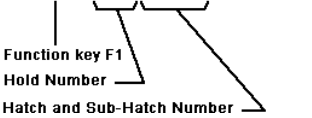
Proceed as follows:



Step	Screen	Key	Action
10			Enter the following data to specify the hatch cover: <ul style="list-style-type: none"> • Hold number • Hatch number • Sub-Hatch number (if necessary) • Number of panels on the hatch • Bow direction (this allows you to indicate the position of the bow on the downloaded test sketch) • Press the enter key to confirm input values. • Press function key F1 (Exit) to go back to the previous screen.
11			Position the SDT8 MS transmitter in the hold. <ul style="list-style-type: none"> • Press the enter key to continue.
12	 		Enter the position of the SDT8 MS transmitter in the hold. <ul style="list-style-type: none"> • Use the arrow keys to move the cursor around. • Press the enter key to confirm the location • Press function key F1 (Exit) to go back to the previous screen.

15.3.4 Storing the Open Hatch Value

Prior to testing the tightness of hatch covers the operator is requested to measure the OHV (Open Hatch Value) for the hold to be tested. Therefore the multi-transmitter is to be placed (**switched on**) in the center of either the tank top or tween deck of the hold in question or on top of the cargo in the open uncovered hold. The OHV measurement is then to be made at hatch coaming level pointing down the receiver’s sensor to the multi-transmitter. Alternatively, and depending on the hold design, the OHV can be taken from an access hatch (provided there are no obstructions between the transmitter and the operator’s SDT 270 (e.g. trunks, ...))

Important note: operators should always carry out the test with the same sensor (internal or flex) with which they have taken the OHV. Switching of sensor during the test will result in non-conforming test readings/measurements.

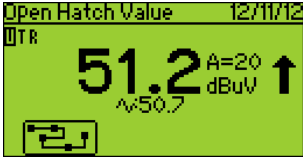
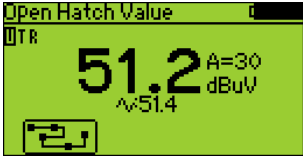
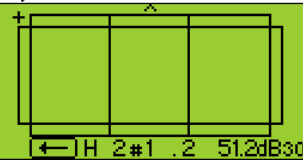
Whilst taking the OHV, the operator will have the possibility to adjust the headphone sound level of the OHV so that the max sound of the OHV is not too loud for comfort. However, once the OHV has been taken and confirmed, this sound level cannot be changed anymore until the next OHV for another hold is taken.

Step	Screen	Key	Action
13		M	Use the up and down keys to adjust the receiver's amplification level until the amplification indicator disappears from the screen. <ul style="list-style-type: none"> • Press the M key to freeze the measured value. • This value will be displayed in bold on the screen • The small sized revolving number under the bold measurement displays the continuous measured value. • Press function key F1 (EXIT) to go back to the Sherlog main menu (see step 3 of this procedure)
14		M	Freeze on a representative Open Hatch Value. Press the save key (diskette icon) to store the measurement.
15		Arrow keys	Enter the location, where the Open Hatch Value was measured, on the display. (By default, the OHV is positioned in the left hand side upper corner). <ul style="list-style-type: none"> • Use the arrow keys the move the cursor around. • Press the enter key to confirm. • Press function key F1 (Exit) to go back to the previous screen.
16			During the save action a confirmation screen is shown.

Note: an additional Open Hatch Value can be memorized if needed.

15.3.5 Storing a measurement

Proceed as follows:

- Direct the flexible sensor to the area to be controlled.
- A measurement is to be performed while listening to the sound in the headphones.
- The LED in the middle of the keyboard gives an indication of the importance of the measured value, i.e. if the measured value is either above of below the 10% threshold.

GREEN: measured value is below the 10% threshold.

RED: measured value is above the 10% threshold.

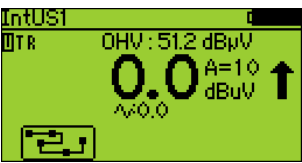
Step	Screen (Icon / Text mode)	Key	Action
17		Up/Down arrow keys	Use the up and down keys to adjust the receiver's amplification level. Set the amplification to A=90. <i>Not doing this adjustment may cause to miss small leaks</i>
18			Place the internal or external sensor close and directed to the seal. Listen to possible ultrasounds with the headphones.

Step	Screen (Icon / Text mode)	Key	Action
19		M	<p>When you hear a sound, press the M key to freeze the measured value.</p> <ul style="list-style-type: none"> Press the M key repeatedly to refresh the frozen measured value.
20		Save	<p>Press the save key to store the measurement.</p>
21		Leak Menu	<p>Select the leak type (see icon codes below)</p> <ul style="list-style-type: none"> Use the arrow keys to switch between the different types. Press the enter key to confirm.

Symbol	Text	Symbol	Text
	Open Hatch IN		Open Hatch END
	Spot Leak		Ventilator
	Linear Leak		Loading Port
	Drain		











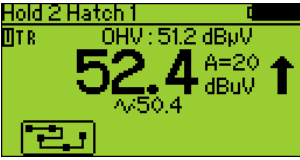

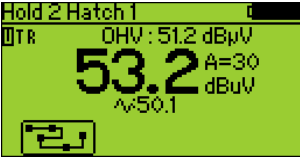

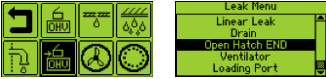
Symbols showing possible leak types.

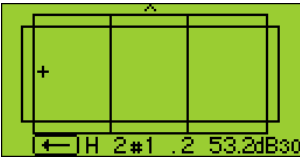

Step	Screen	Key	Action
22		Cursor	<p>Enter the location of the leak on the screen.</p> <ul style="list-style-type: none"> Use the arrow keys to move the cursor around. Press the enter key to confirm. Press function key F1 (Exit) to go back to the previous screen.
23		Enter	<p>An additional comment can be added to the leak.</p> <ul style="list-style-type: none"> Press the enter key to confirm.
24			<p>During the save action a confirmation screen is shown.</p>
25			<p>The basic measurement screen is once again displayed.</p> <p>Repeat steps 17 to 25 until all leaks are spotted.</p>

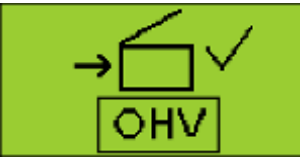
15.3.6 Storing the Open Hatch End Value

End the tightness test of each hatch of the hold in question by measuring the OHV End (Open Hatch End Value). Doing so will confirm proper functioning of the equipment since the start up to completion of the test on the hatch in question. Moreover, and without making this OHV End measurement, the operator will not be allowed to continue his survey and start a test on the next hatch.

Proceed as follows:

Step	Screen (Icon / Text mode)	Key	Action
26			<ul style="list-style-type: none"> Use the up and down keys to adjust the receiver's amplification level. Press the M key (repeatedly) to freeze a representative Open Hatch End Value.
27			Press the save key to store the measurement.
28		 	<p>Select  / Open Hatch END</p> <p>Press the enter key to confirm.</p>
29		 	<p>Enter the location of the measured Open Hatch End Value on the screen.</p> <ul style="list-style-type: none"> Use the arrow keys to move the cursor around. Press the enter key to confirm.
30			During the save action a confirmation screen is shown.
31		 	<p>Select one of the following options:</p> <ul style="list-style-type: none"> Return to the measurement screen to add an additional OHV End value. Go to the Hold-Hatch information screen to add a new hold / hatch. View the survey data. End the survey.

Symbol	Text	Function
	Goto Hold Hatch	Add a new Hold and/or Hatch to continue the survey. Go to step 9.
	End Survey	End the survey and return to the Sherlog main menu. Go to step 3.
	View Survey Data	Browse through all tested holds and hatches of this survey. <ul style="list-style-type: none"> Use up and down arrow keys to browse the holds and hatches Use left and right arrow keys to browse the different measurements of a hatch.

See 10.2.1 Browse survey data







15.4 Ending / Interrupting / resuming a survey

It is possible, at any time, to interrupt the survey in progress. Once interrupted, the survey can then be resumed without losing the stored data.

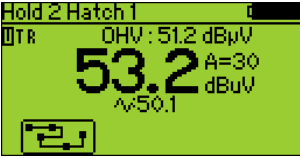





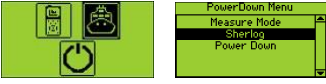

However, once the “OHV End” has been taken and confirmed, no changes of measurements can be made for that specific hatch anymore.

Once the operator has selected the “END SURVEY” function, the survey will be “locked” (padlock icon on the “browse/resume survey menu will be closed/locked) and no changes whatsoever can be made for that specific survey anymore.

Proceed as follows:

Step	Screen (Icon / Text mode)	Key	Action
1			Press function key F1 () to enter the survey menu.
2		 	Select  / End survey • Press the enter key to confirm.

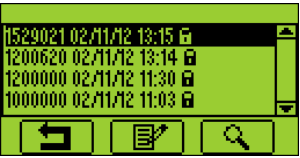
To resume the survey, proceed as follows:

Step	Screen (Icon / Text mode)	Key	Action
1			Switch on the SDT270 receiver
2			Enter the Sherlog Mode: • Select  / Sherlog • Press the enter key.
3			Resume a hatch cover test procedure:. • Select  / Browse survey / resume • Press the enter key.
4			Select the survey. • Press function key F2 () to resume the survey

This function allows to resume the survey from the moment it was interrupted



Always keep in mind that:

- **Stored data cannot be modified afterwards.**
- **Measurements can only be added to a hatch when no “Open hatch END” value has been taken.**
- **Once an “Open hatch END” value has been taken, you can only add new hatches to the survey.**

When you change the sensor (Internal sensor to an external sensor or vice versa) a warning to draw your attention to this change, is displayed.









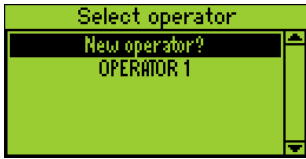

Press Function Key F2 () to continue.

Note: Normally, tests will be carried out with the flexible sensor because this adds to the comfort of the operator. However, be aware of the fact that changing from sensor during the test will result in different measurements, depending on the size of the sensor used

(internal sensor, flex,...). If necessary to switch from sensor (due to breakdown of the sensor in use), the sensor's ID will appear on the download. It is therefore recommended to have a spare flexible sensor in the kit.

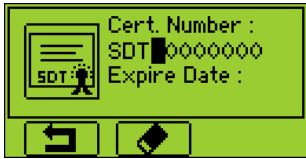
15.5 Adding a new operator

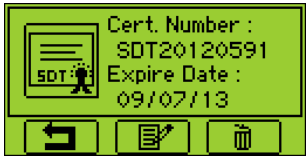
To add a new operator, proceed as follows:

Step	Screen	Key	Action
1			Select " New operator? " and press the enter button.
2		 	Enter the operator's name by using the arrow keys. <ul style="list-style-type: none"> • Press the enter button to confirm.
3		 	Enter the operator's Certificate number and the certificate expiration date. <ul style="list-style-type: none"> • Press the enter button to confirm. • A certificate renewal status can only be entered after you have entered the original details of the certificate. Afterwards you can edit the certificate again and add the renewal status. eg: SDT20120591-1
4			<ul style="list-style-type: none"> • Press the enter button to confirm. • The operator is added to the list

The Sherlog report software

16 Using the report software

All data logged during a hatch cover tightness test performed following the Class procedure (see chapter 15 The Class required hatch cover ultrasonic tightness) can be downloaded to a PC computer for backup and editing purpose as well as enhanced reporting.

16.1 Installation of the software

Installation from the USB flash drive:

- Plug the USB flash drive delivered with your equipment in a USB port of your computer and run the file "starMe.exe".
- After choosing "Sherlog" and then "Sherlog Master", select "Install Reporter Software"

Online installation:

- Download the file "SDT270-SherlogReporter.msi" on your computer and run this file when download is complete.

Starting up the installation:

You should now see the following screen:

- Click "Next".

Then, the following screen appears:

By default, the SDT270 SherlogReporter software will be installed in the folder: C:\Program Files\SDT\SDT270 SherlogReporter.

You can specify a different location at your convenience by clicking on "Browse".

- Click "Next".

The following screen appears:

- Click "Next".

A new screen confirms the software is installed. Click "Close" to complete the setup.

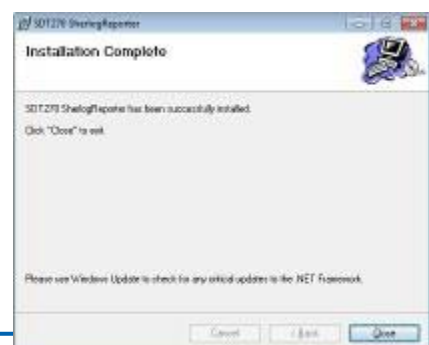
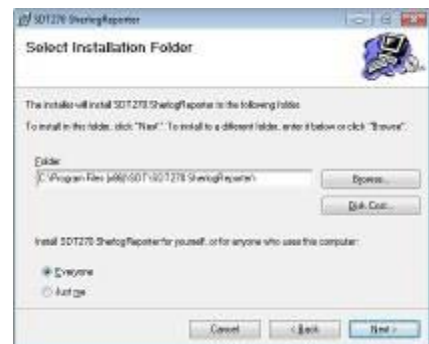

16.2 Connecting the device

Connecting the device by USB

Proceed as follows:

Connection of the device to a computer.

- Connect the first end (mini USB connector) of the USB cable to the device.
- Connected the other end (USB connector) of the USB cable to a USB port of the PC.
- Switch on the device.





Connection of the device to a computer.

Connecting the device on a computer network

A special optional cable is required to connect the device on a computer network.

Proceed as follows:

From the device **Main Menu**

- Highlight the  / **Settings** Menu and then press the **Enter key**.
- Using the **Arrow keys**, move around till highlighting the  / **Network** Menu and then press the **Enter key**.
- Insert an IP Address.
- Insert a Gateway

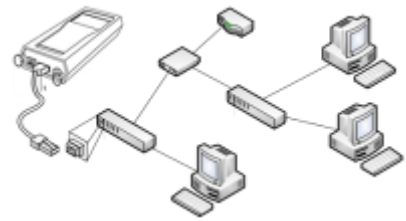

Connection of the device to a computer network.

The **Right and Left Arrows** are used to switch from field to field and **Up and Down Arrows** are used to increment or decrement a field value.



Enter the IP address and Default gateway. Your system administrator and/or the network administrator will have this information.

For more assistance, please contact your system administrator.

- Enable the LAN by setting the “LAN enabled” field to **Yes**



When your device is not connected to a Network, it is advised to parameter the LAN to disable. This setting permits to increase the battery autonomy of more than 20%. Use the **Right Arrow** to highlight the **LAN enabled** field, then using the **Up Arrow** set the field to **YES**.

- Press the **Enter Button** to validate the changes.
- Press the **Escape Button** to return to the settings menu.

16.3 Downloading the data

Once the software is installed and the device is connected, you can download the data from the device.

Proceed as follows:

- Launch the software “SDT270 - Sherlog Reporter”.

The screen displays the main page.

- Click “**Download Device Data**”

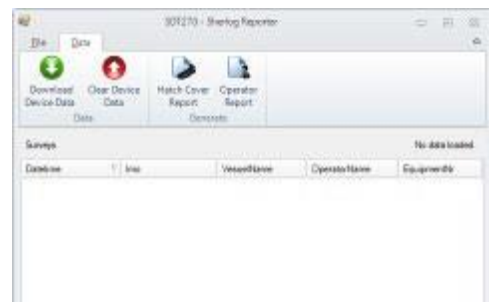

You will see the following screen:

Check the correct option depending on how the device is connected to the computer.

- Click “Transfer”

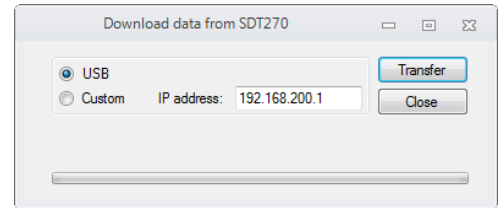

If a connection error message is shown, please check if the device is connected and switched on.

If the download was successful, you will see the following screen:

- Only finished surveys can be downloaded.
- Select a survey and click the “Hatch Cover report” button.

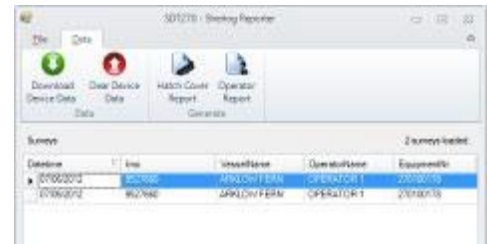

You will see the following screen:

- Browse to the desired report location and click “Save”.

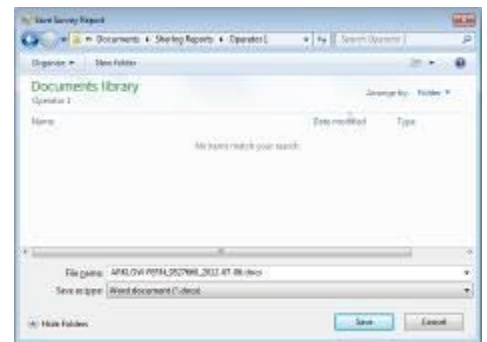

A MS Word 2010 report (.docx) is generated at the specified location.

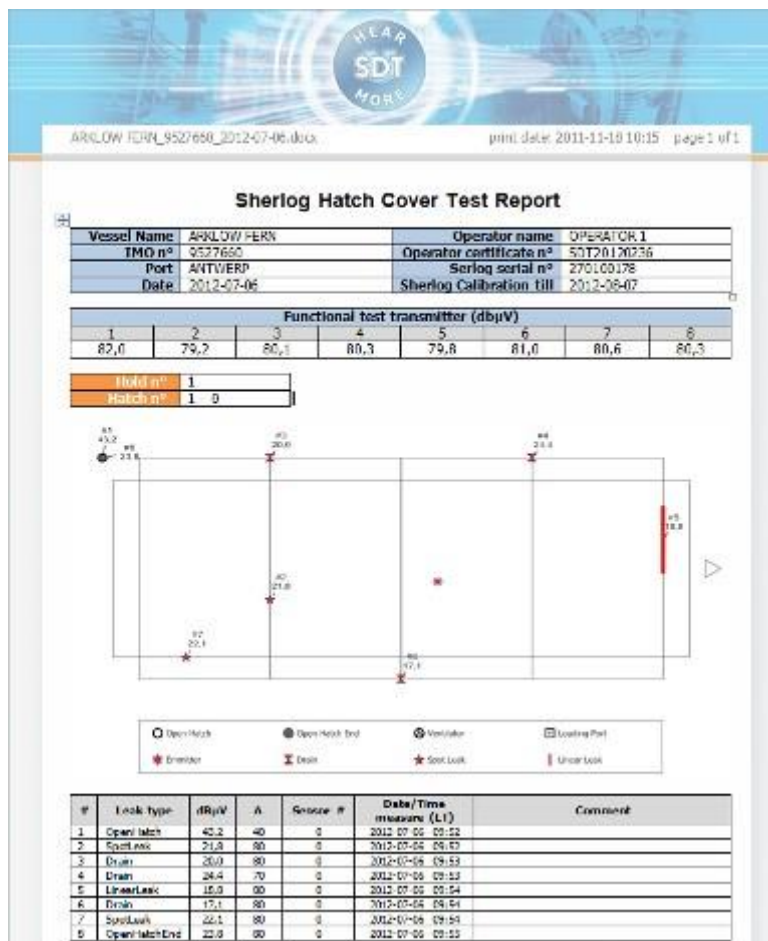

Example of the generated hatch cover test report.

16.4 Erasing the data

It is not possible to manually erase or alter the logged data on the device.

To clear the data from the device, proceed as follows:

- Connect the device to the computer.
- Switch on the device.
- Launch the software “SDT270 - Sherlog Reporter”.

The screen displays the main page.

- Click “**Clear Device Data**”.

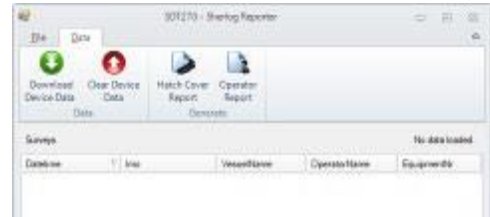

You will see the following screen:

Check the correct option depending on how the device is connected to the computer.

- Click “**Transfer**”

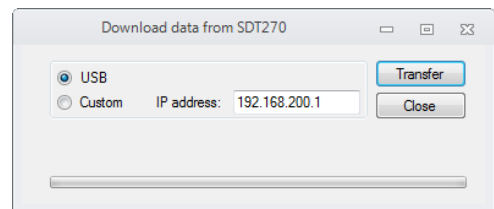

An additional confirmation is required.

- Click “**OK**”

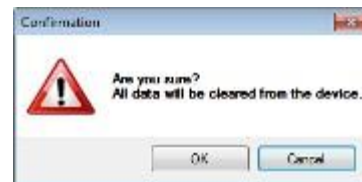

After this operation all taken “Hatch cover test” surveys are erased from the device.

Please notice that the list of operators remains on the device.

Erased data will remain on the device in a hidden memory.

Technical specifications

17 SDT270 receiver

17.1 Measurement instrument

Function	Multifunction receiver.
Display	Graphic LCD with backlighting (128 x 64)
Keyboard	12 function keys
Built-in sensors	Ultrasonic sensor Infrared temperature sensor (according to the version) Tachometer (according to the version)
External sensors	Through specific connector (Lemo 7 pins).
Data storing	For SDT270 SB: <ul style="list-style-type: none"> Data storing is possible in Sherlog mode No data storing is possible in Measurement mode More info on all other SDT270 versions can be found on www.sdtultrasound.com
Communication	USB interface
Software's for transferring data from the device to the PC	DataDump Application (versions SD & DD) Ultranalysis Suite (UAS) (versions SU & DU) Sherlog Reporter (only for Sherlog)
Battery pack (*)	Rechargeable battery type: 8 cell, 4.8 V, 4400 mAh, NiMH (Nickel Metal Hydride) Nominal Capacity: 4.4 Ah
Life span	500 to 1,000 charge/discharge cycles
Autonomy	8 hours without backlighting
Recharge time	6 to 7 hours
Protections	Short-circuit, reverse polarity and temperature protected
Auto power down	Auto power down after preset time
Operating temperature	-15 °C to +60 °C / 14 °F to 140 °F non condensing
Housing	Extruded aluminium
Weight	830 g / 29.3 oz. (with battery and holster included)
Dimensions	226 x 90 x 40 mm / 8.90 x 3.54 x 1.57 inches (L x W x H)
Holster	Fluor silicone resistant to hydrocarbons
Headphones	130 dB, noise isolating.

(*) for optimum performance, this battery pack is equipped with an electronic management system (includes digital serial number, capacity and temperature management).

17.2 Internal ultrasonic sensor

Function / type	Open type ultrasonic sensor
Bandwidth (-6 dB)	±2 kHz at -6 dB
Frequency	40 kHz ± 1 kHz
Sensitivity (40 kHz)	-65 dB/V/μbar at 40 kHz
Total beam angle	55° typical at -6 dB

17.3 Flexible sensor

Bandwidth (-6 dB)	2 kHz at -6 dB
Frequency	40 kHz \pm 1 kHz
Sensitivity (40 kHz)	-65 dB/V/ μ bar at 40 kHz
Length	550 mm or 820 mm (without cable)
Diameter	13 mm external, 10 mm internal
Cable length	Coiled 0.5 to 2.0 m

17.4 Battery charger

For optimum performance, this charger is microprocessor controlled.

Charger type	Specific for SDT270NiMH battery pack.
Power supply	230 VAC or 110 VAC +15 % / -10 % 50/60 Hz
Output voltage	+4.0 or 8.5 V DC (depends on operating mode)
Current	1000 mA maximum
Protections	temperature protected, limit set at 60°C / 140 °F
Status indicator	Two color LED type. <ul style="list-style-type: none"> • Green LED is continuously lit: battery is fully charged • Green LED flashes evenly: normal charge • One red flash every 5 seconds : Battery Voltage error • Two red flashes every 5 seconds: Over temperature error • Three red flashes every 5 seconds: Timeout full charge • Four red flashes every 5 seconds: Timeout Rapid charging • Five red flashes every 5 seconds: Timeout Activate charging • Six red flashes every 5 seconds: 1 Wire communication error
Isolation	Double isolation.
Weight	300 grams / 10.6 ounces
Housing	PPE.

18 SDT 8 MS transmitter

18.1 Transmission characteristics

Function	Ultrasonic multi-transmitter
Frequencies	Stabilized at 39.2 and 39.6 kHz (bi-sonic mode).
Nbr of transducers	8
Transmission power	Power control in 6 levels Typical values form 1 to 6 : -20dB, -15dB, -9dB, -6dB, -2dB, max.
Maw trans. Power	8 x 125 mW
Dispersion	240 °

18.2 Supply

Voltage/capacity	12V DC/1,2 Ah.
Battery	Sealed lead-acid gel type rechargeable.
Recharge	By means of an external charger and integrated connector (without removing the battery) or by using a charge adapter (removing the battery).
Autonomy	2.5 to 3.5 hours at 20 °C. (depends on the selected level)
Charging time	6 hours.
Safety	Chemical control fuse with automatic reset.

18.3 On / Off switch

Command	By On/Off switch
Visual indication	On/Off/Battery charge control indicator. Flashes when undercharged.

18.4 Others

Temperature range	-20° C to +50° C (°F)
Dimensions	160 x 100 x 95 mm (L x W x H)
Weight	1.5 kg

Appendixes

19 SDT270 Declaration of conformity in the European Union

Manufacturer
SDT International n.v. s.a.
Boulevard de l'Humanité 415
B - 1190 BRUSSELS
BELGIUM



declares that, under the generic name "SDT 270 Multifunction Receiver", the

SDT270

making the object of this declaration, is conform to the fundamental description concerning security stipulated in de EMC 89/336/CEE directive.

The equipment contains the  logo of being compliant to the current CE regulations.

To be able to operate by state of the art rules, as stipulated in the directive, it has been designed by the following rules:

- The *SDT270* does not radiate electromagnetic waves (EMC);
- The *SDT270* is immunized against external electromagnetic radiation (EMI);
- The *SDT270* is protected against electrostatic discharges (ESD).

Note: the owner is obliged to preserve the present user's manual with the obligation to pass it on to future users, or been resold to another user.

Brussels, January 2003.

The Manager.

20 SDT 8 MS Declaration of conformity in the European Union

Manufacturer
SDT International n.v. s.a.
Boulevard de l'Humanité 415
B - 1190 BRUSSELS
BELGIUM



declares that, under the generic name "SDT 8 Ultrasonne multi-transmitter", the

SDT 8 MS transmitter

being the object of the declaration, conforms to the fundamental descriptions with regard to safety stipulated in the CEM 89/336/EEC directive.

The equipment carries the conformity label .

To implement the safety prescriptions stipulated in the Directive as well as possible, the following standards were taken into consideration. So, the transmitter:

- Does not emit any electromagnetic waves (EMC) ;
- Is immunised against transmissions of external electromagnetic waves (EMI) ;
- Is protected against electrostatic discharges (ESD).

Note: the owner of the equipment is obliged to keep this manual throughout the entire life of the device and to pass it on to the new buyer if it is resold.

Brussels, March 2003.

The Manager

21 Copies of certificates



SDT270_270100030_Calib-FuncTest_28195.doc print date: 2010-09-01 16:10 page 1

Functional Test Report

Device: SDT270 No **270100030** (PCB No 271100077)

Session No: 28195

Verification and calibration instruments:

- Generator SDT ref: FUSITE No 109110005 (v85)
→ calibrated with Multimeter Keithley Type 2000 No 1268134 on 27/01/2012 (due date: 27/01/2013)
- Software: SDT2xxCalibration (v2.9.880.0)

Procedure ref: IT.R270.PC.001

Test result: **OK**

Tested item		Result
Black Lemo connector (channel 2)	Analog input A	OK
	Analog input B	OK
	Dynamic input B (for parabolic dish)	OK
	Ultrasound input	OK
	Supply voltage output	OK
	Sensor detection capabilities	OK
	Sensor communication (I2C)	OK
Red Lemo connector (channel 3)	Analog input A	OK
	Analog input B	OK
	Ultrasound input	OK
	Supply voltage output	OK
	Sensor detection capabilities	OK
	Sensor communication (I2C)	OK
	Accelerometry power supply (ICP)	OK
	Communication with Teds accelerometers	OK
USB Connection		OK
Power supply plug*		
Headset plug*		
Backlight*		
Keyboard*		
Internal sensor*		
Temperature measurement*		
RPM measurement*		

* manually tested by operator

Generated on: 16/10/2012 **by:** SDT International

SDT International - Bd. de l'Humanité, 415 - 1190 Brussels - Belgium - Phone : +32 (0) 2 332 32 25 - Email : info@sdtd.be

SDT270_270100030_Calib-FuncTest_28195.doc

print date: 2010-09-01 16:10 page 2

Calibration Report

Device: SDT270 No **270100030** (PCB No 271100077)

Session No: 28195

Verification and calibration instruments:

- Generator SDT ref: FUSITE No 109110005 (v85)
→ calibrated with Multimeter Keithley Type 2000 No 1268134 on 27/01/2012 (due date: 27/01/2013)
- Software: SDT2xxCalibration (v2.9.880.0)

Procedure ref: IT.R270.PC.001

Test result:

A = 100 dBVout = **100.00** mV Limit values: min. 99.9 mV – max. 100.1 mV

Generator dB μ V	Ampli SDT270 dB μ V	Reading values SDT270 dB μ V		Limit values dB μ V	
		Before intervention	After intervention	Min.	Max.
20	80	19.99	20.09	19.60	20.40
30	70	29.98	30.04	29.60	30.40
40	60	39.94	40.01	39.60	40.40
50	50	49.98	50.06	49.60	50.40
60	40	59.95	60.03	59.60	60.40
70	30	69.92	70.00	69.60	70.40
80	20	79.92	80.01	79.60	80.40
90	10	89.88	89.98	89.60	90.40

Conclusion:

Corresponding to the maximum allowed deviations: **YES**

Generated on: 16/10/2012 **by:** SDT International

SDT International - Bd. de l'Humanité, 415 - 1190 Brussels - Belgium - Phone : +32 (0) 2 332 32 25 - Email : info@sdtt.be

Copy of a Calibration Report.



Certificate of Qualification

nr. SDT0

This is to certify that **Mr.** [REDACTED]

has, in accordance with Classification Societies Requirements i.e.

- DNV – Approval Programme N° 403, Standards for Certification N° 2.9 – May 2001
- IACS U.R. Z.17 Procedural Requirements for Service Suppliers Rev.5 – Feb. 2004,

attended the following theoretical and practical modules of the SDT-IMCS training course, accredited by the Nautical Institute. This training was given at the Hilton Dubai Jumeirah in UAE on 15th and 16th March 2006.

Module	Completed
<i>Theoretical training on hatch covers & closing appliances</i>	✓
<i>Theoretical training on Ro-Ro access equipment & securing devices</i>	
<i>Theoretical training on Ultrasounds and with a SDT Sherlog TA</i>	✓
<i>Practical training with a Sherlog TA (survey data logging procedure and downloading to PC)</i>	✓
<i>On-Board training with a Type Approved Sherlog TA detector in combination with a Sherlog 8 multi-transmitter and external flexible sensor on the vessel IRAN BORHAN IMO n°7360784 in the port of Dubai Port Rachid.</i>	✓

On completion of the training course, Mr. [REDACTED] has successfully passed the theoretical and practical examination and has therefore been certified as "Certified Operator qualified for ultrasonic tightness testing with the Class Type Approved Sherlog TA" of hatches.

This certificate is valid for a period of 3 years and expires on 01/04/2009.

Issued at Brussels on 28/03/2006.

For SDT International,
André Degraeve
Managing Director.

Training instructor,
Walter Vervloesem.

22 Warranty and responsibility limits

22.1 Warranty

22.1.1 Guarantee

Subject as hereinafter set out, **SDT** undertakes to remedy any defect of the equipment resulting from faulty materials or workmanship. The guarantee undertaking includes measures for repairing or replacing the equipment. This liability is limited to defects, which appear:

- For the battery and accessories (such as charger, headphones, sensors, ...) within six (6) months from the delivery of the equipment to the customer,
- For the *SDT270* receiver and multi-transmitter within twenty-four (24) months from the delivery of the equipment to the customer.

On receipt of the customer's written notification falling within this guarantee **SDT** shall remedy the defect forthwith and at its own expense. The customer shall return to **SDT** the equipment, in which a defect covered by this guarantee has appeared, for repair or replacement by **SDT**, and the delivery to the customer of the equipment properly repaired or replaced shall be deemed to be a fulfillment by **SDT** of its obligations and a sole and exclusive remedy under this guarantee in respect of such defective equipment.

The customer shall bear the cost and risk of packing and transport of the defective equipment and of the repaired or replaced equipment between the place where the equipment is situated and **SDT** closest office.

SDT's liability shall apply only to defects that appear under the conditions of operation provided for by this User Manual and in proper use. It does not cover defects due to causes arising after delivery. In particular it does not cover defects arising from the customer's faulty maintenance, installation, handling, service or inspection or non-compliance with **SDT's** instructions in this User Manual, in **SDT's** Technical Specifications or given otherwise or from repairs, alterations or adjustments carried out without **SDT** prior written consent or from repairs, alterations or adjustments carried out improperly by the customer or arising from an accident, nor does it cover normal deterioration, wear and tear.

22.1.2 Limitation of liability

If the customer fails to give notice of a defect that falls within this guarantee during the above stated guarantee period, **SDT** shall be under no liability even in respect of defects due to causes existing before the expiry of the above stated guarantee period.

SDT liability under this guarantee shall in all cases be limited to fifteen per cent (15%) of the purchase price of the equipment. In addition, it is expressly agreed that the customer shall have no claim in respect of personal injury or of damage to property arising before, during or after the above stated guarantee period nor for loss of profit, loss of use or any other indirect, consequential, punitive, special or incidental damages of any kind, whether or not **SDT** has been advised of the possibility of such loss or damage.

22.2 Responsibility limits

Neither the company **SDT International**, nor any related company, will in any circumstances be liable for any damages, including, without limitation, damages for loss of business, business interruption, loss of information, defect of the equipment unit or its accessories, bodily harm, loss of time, financial or material loss or any other indirect or consequential loss arising out of the use, or inability to use this product, even when it has been warned of possible damages.