

Datasheet FU.SEN.RSV.002 0-10V Heterodyne Airborne Sensor IP65 S/N 570YYXXX

General description:

RSV are ultrasound heterodyned voltage output sensors designed to be used with industrial standard measurement systems (such as PLC, DCS and DAQ systems) and VIGILANT, powered by SDT.

The design is optimized for permanent installations in the most challenging environment. RSV airborne sensors are suitable to permanent installation on electrical assets or to leak detection. Sensitive to friction, impact and turbulence, RSV deliver analog signals, adjustable in gain and in mode, that are image of the resonant ultrasonic band-pass.



Features:

- Static (RMS value/DC coupling) or dynamic (heterodyned signal/AC coupling) output;
- On board amplification stages;
- Built-in analog filters;
- Hardware calibration;
- On board ambient T° measurement (through serial communication);
- Non-volatile memory (used to save configuration and recover sensor state/mode upon power outage);
- Unique ID;
- Digital I/O communication for simple use;
- Serial communication for advanced use.

Top view pinout (IEC 60947-5-2 compliant):

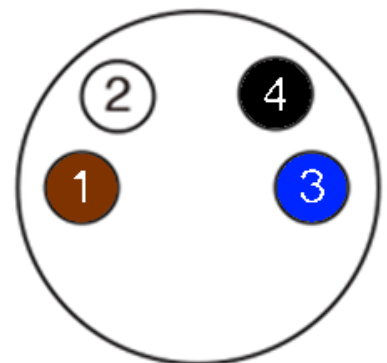

- 1 = POWER SUPPLY (Brown)
- 2 = OUTPUT VOLTAGE (White)
- 3 = GROUND (Blue)
- 4 = COMMUNICATION LINE - should be left floating if not used – (Black)

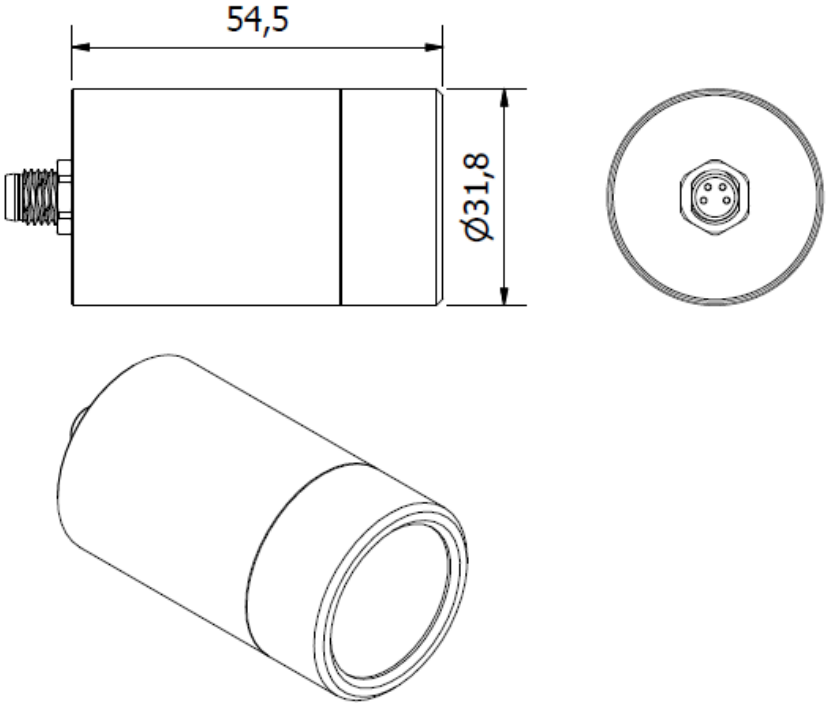

Technical specifications:

General specifications	
Dimensions [mm]	
Function	Resonant ultrasound airborne sensor with heterodyned output
Type of transducer	Piezoelectric ceramic
Materials	Housing: Stainless steel Connector plate: Aluminum
Weight	102 [Gram] / 3.6 [Oz]
IP rating	IP65
Tests/approvals EMC (Directive 2014/30/EU)	<ul style="list-style-type: none"> • EN 61326-1:2013 • EN 55011: 2016 + A1:2017 • EN 61000-4-2:2009 • EN 61000-4-3:2006 + A1:2008 + IS1:2009 + A2:2010 • EN 61000-4-4:2013 • EN 61000-4-6:2014 • EN 61000-4-8:2010
Installation	
Power supply	10 [V] to 30 [V]
Maximum consumption	1.2 [W]
Operating temperature	-20 [°C] to +70 [°C] / -4 [°F] to +158 [°F]
Pinout voltage	GROUND to VDD
Recommended maximum cable length	30 [m] / 100 [feet]

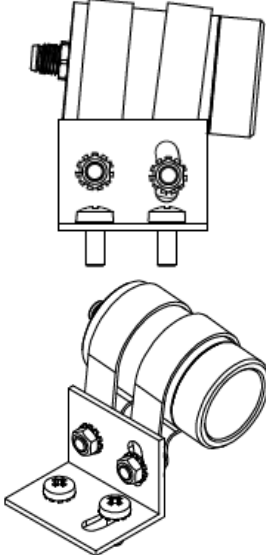
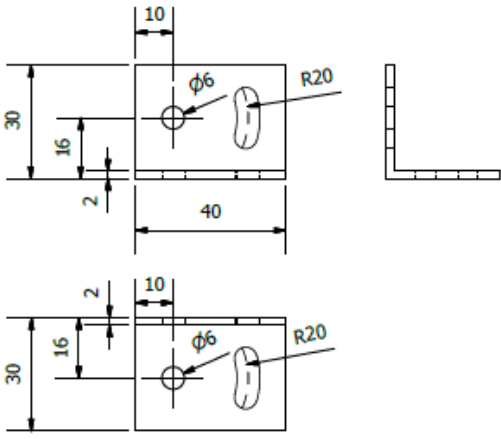
Mounting options	See accessories
Sensor signal (Typical)	
Resonant frequency	40 [kHz] +/- 1 [kHz]
Gain range	0 [dB] to 60 [dB]
Gain step	12 [dB]
Connector size	M8 - 4 pin
Heterodyned signal (Typical)	
Heterodyne frequency	38.5 [kHz] +/- 1 [kHz]
Bandwidth	[0.25 – 4] [kHz], image of the ultrasonic signal
RMS Time Period	1 [s] (static mode only)
Absolute maximum voltage range	0.5 [V] to 10 [V] *Adjust the Gain if the voltage output is not within [1-5 V]
Full measuring range	~ 32-106 [dB μ V _{RMS}] (in static mode)
Factory configuration	
Signal mode	Dynamic (sampleable from 10 kHz, referring to your recording instrument/PLC/VIGILANT dynamic input)
Gain	60 dB
Optional accessories offered by SDT	
Cables with Straight M8 Connector – PUR RAL7021 -25°C.+90°C IP65 – STRAIGHT SHIELDED	
FU.RSC.CABL.01.015-1	SENSOR-/ACTOR CABLE M8 4PF <> FREE END 1.5m
FU.RSC.CABL.01.030-1	SENSOR-/ACTOR CABLE M8 4PF <> FREE END 3.0m
FU.RSC.CABL.01.050-1	SENSOR-/ACTOR CABLE M8 4PF <> FREE END 5.0m
FU.RSC.CABL.01.100-1	SENSOR-/ACTOR CABLE M8 4PF <> FREE END 10.0m
FU.RSC.CABL.01.200-1	SENSOR-/ACTOR CABLE M8 4PF <> FREE END 20.0m
FU.RSC.CABL.01.XXX-1	SENSOR-/ACTOR CABLE M8 4PF <> FREE END XX.Xm
Cables with 90° M8 Connector – PUR RAL7021 -25°C.+90°C IP65 – SHIELDED	
FU.RSC.CABL.02.015-1	SENSOR-/ACTOR CABLE M8 4PF 90° <> FREE END 1.5m
FU.RSC.CABL.02.030-1	SENSOR-/ACTOR CABLE M8 4PF 90° <> FREE END 3.0m
FU.RSC.CABL.02.050-1	SENSOR-/ACTOR CABLE M8 4PF 90° <> FREE END 5.0m
FU.RSC.CABL.02.100-1	SENSOR-/ACTOR CABLE M8 4PF 90° <> FREE END 10.0m
FU.RSC.CABL.02.200-1	SENSOR-/ACTOR CABLE M8 4PF 90° <> FREE END 20.0m
FU.RSC.CABL.02.XXX-1	SENSOR-/ACTOR CABLE M8 4PF 90° <> FREE END XX.Xm

Connector to complete assembly	
SICOCA-M8-4MSS-01	CABLE CONNECTOR M8 4PM SHIELDED STRAIGHT A-KEY w/SCREW TERMINAL
SICOCA-M8-4FSS-01	CABLE CONNECTOR M8 4PF SHIELDED STRAIGHT A-KEY w/SCREW TERMINAL
Cables with straight M8 connector 4PM <> M8 4PF – PUR BLACK -25°C.+80°C IP65 – STRAIGHT SHIELDED	
FU.RSC.CABL.05.015-1	SENSOR-/ACTOR CABLE M8 4PM <> M8 4PF 1.5m
FU.RSC.CABL.05.030-1	SENSOR-/ACTOR CABLE M8 4PM <> M8 4PF 3.0m
FU.RSC.CABL.05.050-1	SENSOR-/ACTOR CABLE M8 4PM <> M8 4PF 5.0m
FU.RSC.CABL.05.100-1	SENSOR-/ACTOR CABLE M8 4PM <> M8 4PF 10m
FU.RSC.CABL.05.200-1	SENSOR-/ACTOR CABLE M8 4PM <> M8 4PF 20m
FU.RSC.CABL.05.XXX-1	SENSOR-/ACTOR CABLE M8 4PM <> M8 4PF XX.Xm
Mounting accessories	
FA.RSC.ACC.001-01	4-20mA Heterodyne Mounting Accessories/Brackets <div style="display: flex; justify-content: space-around; align-items: center;">   </div>
FU.RSC.ACC.001	<div style="text-align: center;">  </div> <p>Configuration Interface (see DC.RSC.DAT.015)</p>

Normalized heterodyned response curve (typical):

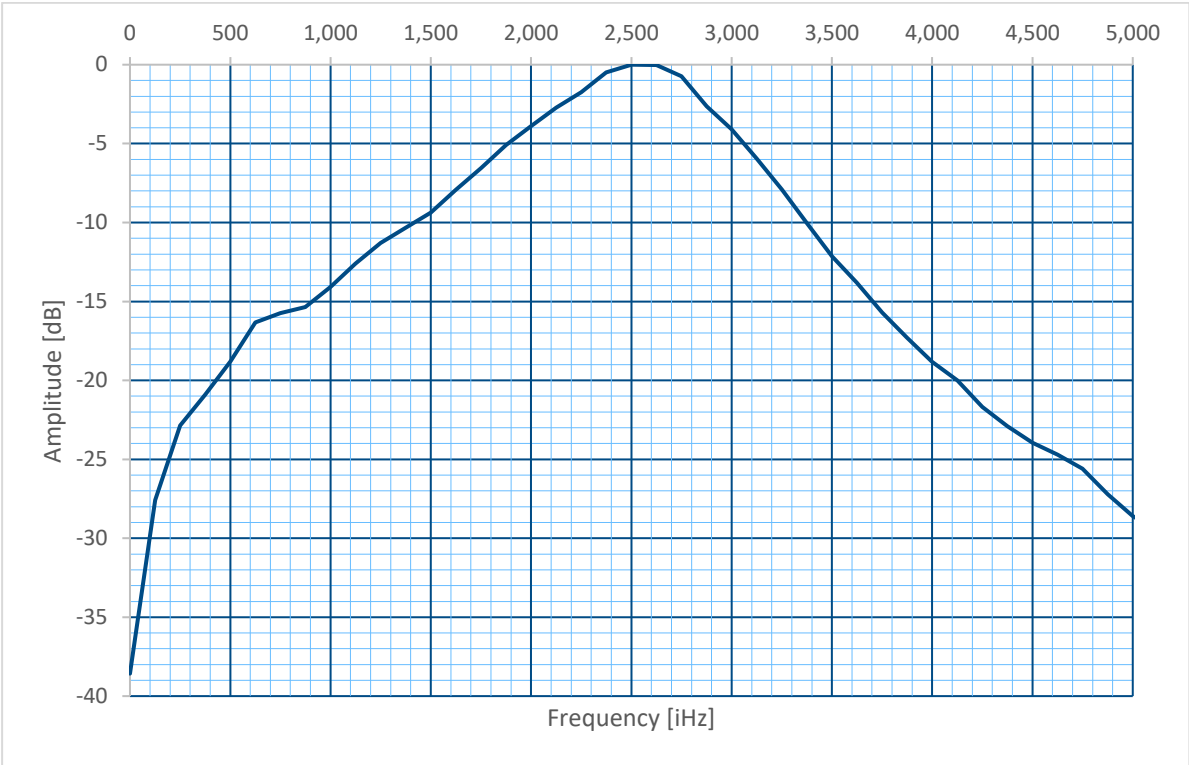

Beam angle:

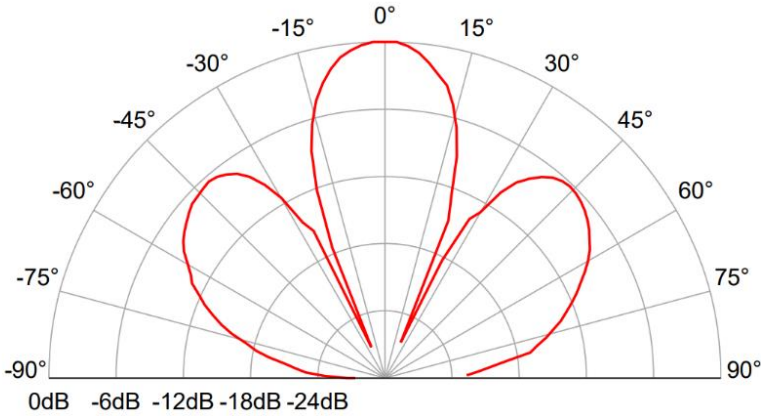

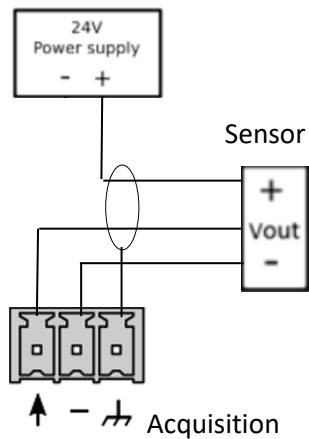
Wiring configuration:**Output equation in static mode:**

- (1) *Sensor signal* [V_{RMS}] = $\frac{\left(\frac{\text{Voltage } [V_{DC} \text{ in } V]}{25}\right)}{\text{linear Gain}}$
- (2) *Sensor signal* [$dB\mu V$] = $20 \times \text{Log} \left(\frac{\text{Voltage } [V_{DC} \text{ in } V]}{25}\right) - \text{Gain} [dB] + 120$
- (2') *Sensor signal* [$dB\mu V$] ~ $3.32 \times \text{Voltage } [V_{DC} \text{ in } V] + 91 - \text{Gain} [dB]$

In static mode, for convenience, SDT recommends expressing the sensor output in [$dB\mu V_{RMS}$] using (2) or (2') since the output refers to the RMS indicator. Please refer to the approximation of the logarithmic scale given in (2'), in case you cannot enter the logarithmic relationship in your acquisition system. Approximating the logarithmic scale in the retain measurement range introduces a maximum related inaccuracy of +/- 2 dB.

Gain [dB]	Linear Gain	Sensitivity [V]/[V]	Offset/ V_{bias} [V]	Optimal range [$dB\mu V_{RMS}$]
0	1	25	0	[92-106]
12	4	100	0	[80-94]
24	16	400	0	[68-82]
36	63	1575	0	[56-70]
48	251	6275	0	[44-58]
60	1000	25000	0	[32-46]

Table 1: Sensitivities according to the gain

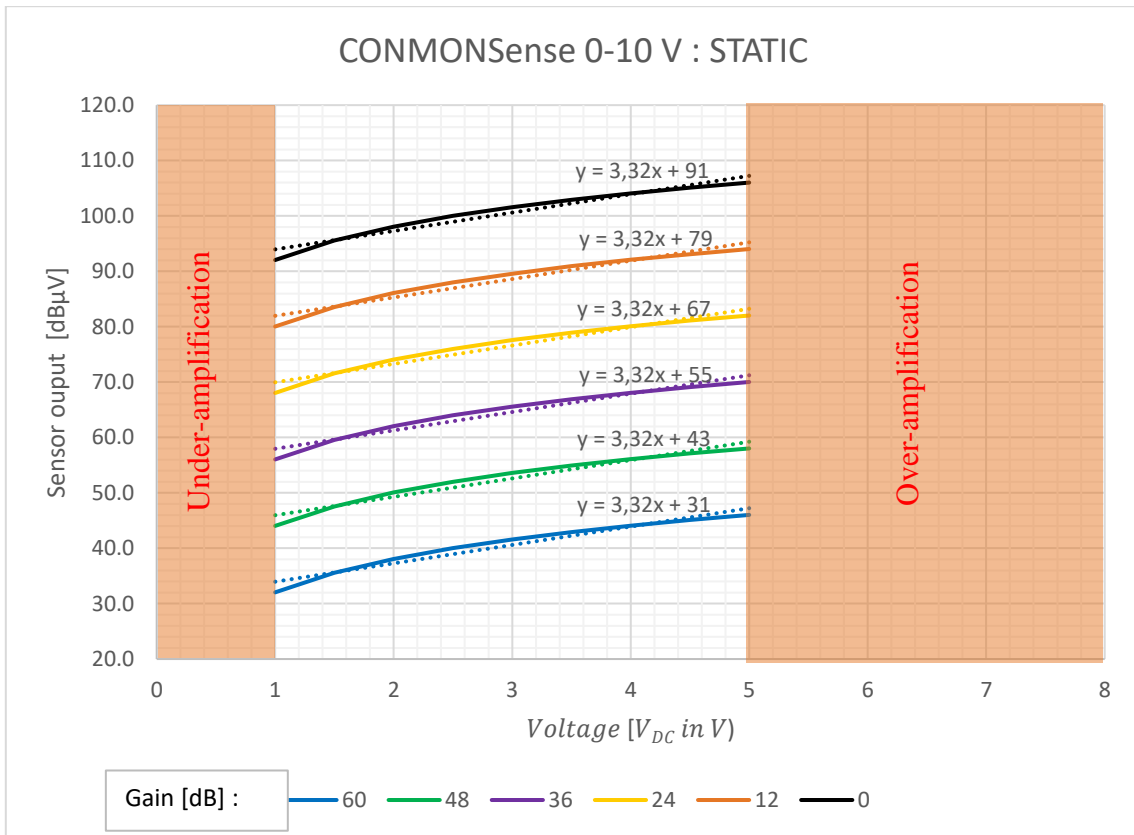

Figure 1: Sensor signal in dBµV vs Voltage, for each gain

Voltage [V _{DC in V}]	Gain [dB]					
	60	48	36	24	12	0
	Sensor signal [dBµV]					
<1	Under-amplification					
1	32,0	44,0	56,0	68,0	80,0	92,0
1,5	35,6	47,6	59,6	71,6	83,6	95,6
2	38,1	50,1	62,1	74,1	86,1	98,1
2,5	40,0	52,0	64,0	76,0	88,0	100,0
3	41,6	53,6	65,6	77,6	89,6	101,6
3,5	42,9	54,9	66,9	78,9	90,9	102,9
4	44,1	56,1	68,1	80,1	92,1	104,1
4,5	45,1	57,1	69,1	81,1	93,1	105,1
5	46,0	58,0	70,0	82,0	94,0	106,0
> 5	Over-amplification					

Table 2 : Voltage conversions in static mode

Output equation in dynamic mode:

- (3) $Sensor\ signal\ [V] = \frac{(Voltage[in\ V] - 3[V_{bias\ in\ V}])}{1.2 \cdot linear\ Gain}$

In dynamic mode, SDT recommends expressing the sensor output in Voltage.

Gain [dB]	Linear Gain	Sensitivity [V]/[V]	Offset/V _{bias} [V]	Optimal range [mV]
0	1	1.2	3	[-1666 ; +1666]
12	4	4.8	3	[-418 ; +418]
24	16	19.2	3	[-105 ; +105]
36	63	75.6	3	[-26 ; +26]
48	251	301.2	3	[-6.6 ; +6.6]
60	1000	1200	3	[-1.7 ; +1.7]

Table 3: Sensitivities according to the gain, in dynamic mode

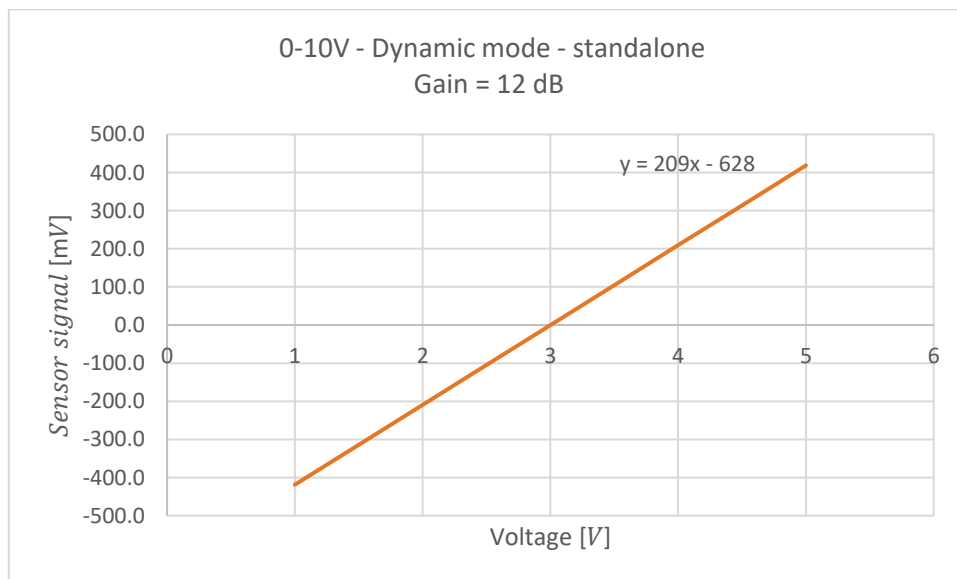
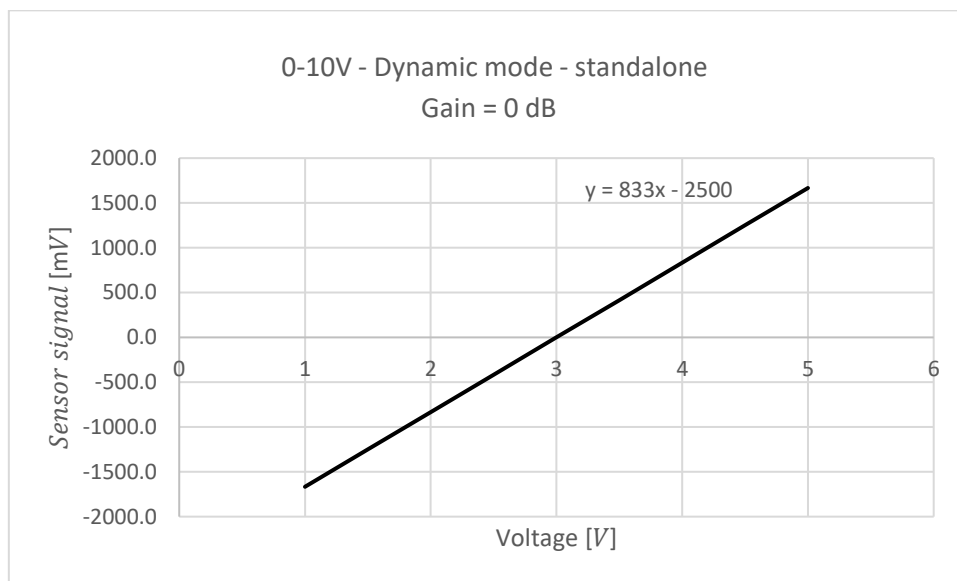

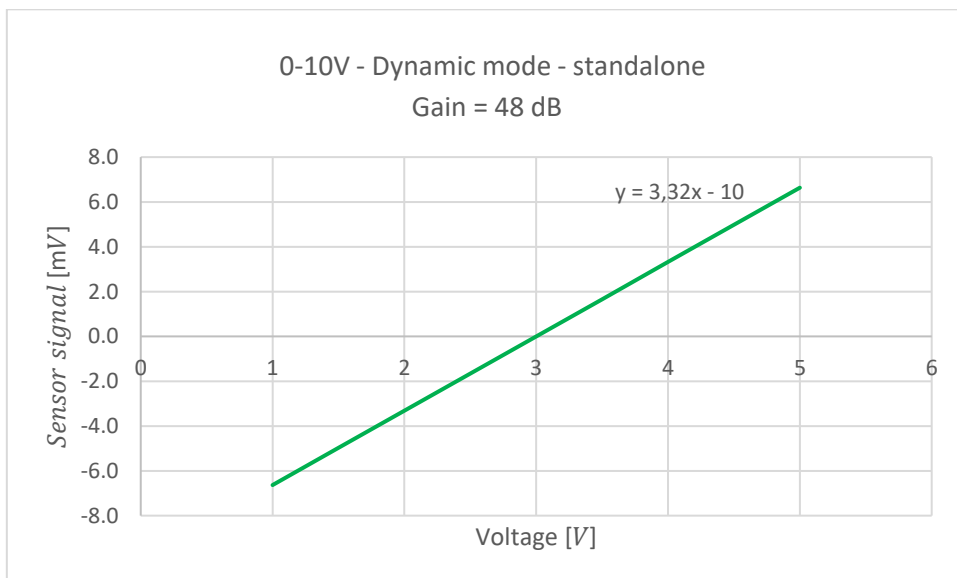
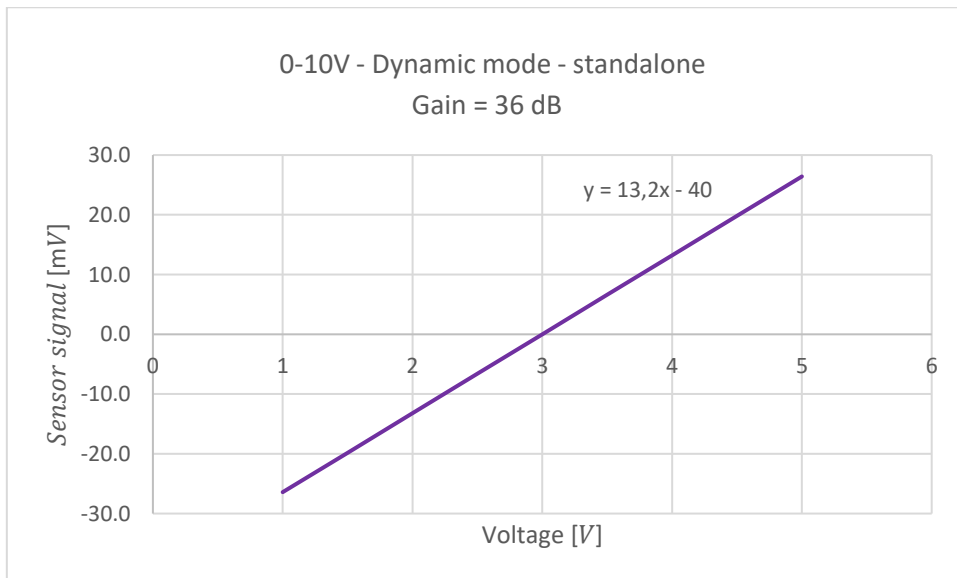
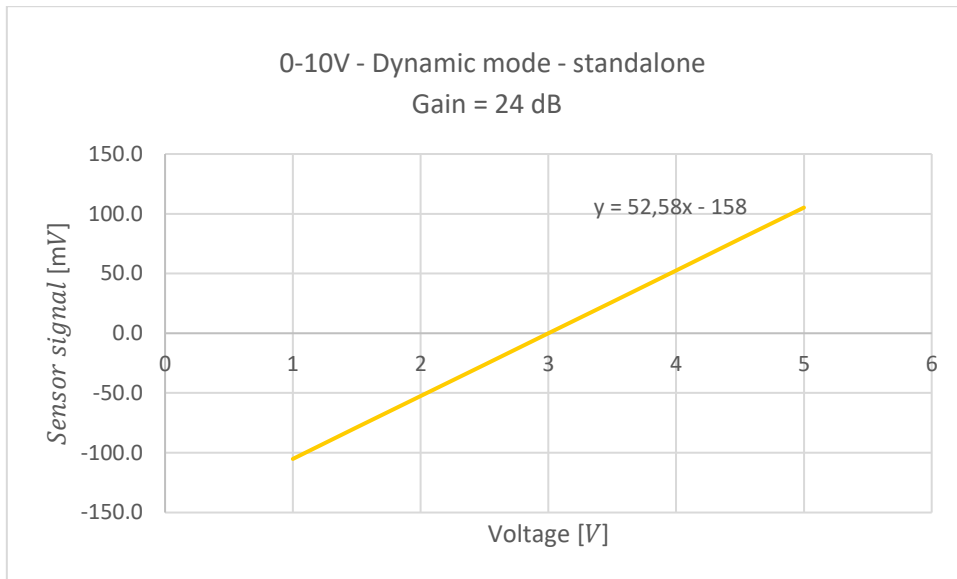

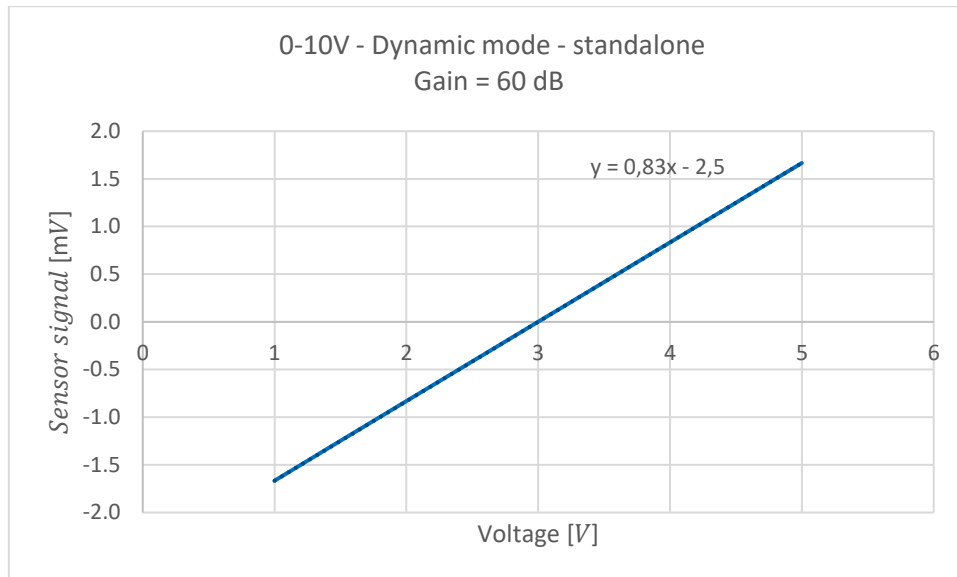

Voltage [V]	Gain [dB]					
	60	48	36	24	12	0
Sensor signal [mV]						
<1	Under-amplification					
1	-1,7	-6,6	-26,4	-105,2	-418	-1666
1,5	-1,3	-5,0	-19,8	-78,9	-314	-1250
2	-0,8	-3,3	-13,2	-52,6	-209	-833
2,5	-0,4	-1,7	-6,6	-26,3	-104	-416
$3/V_{\text{bias}}$	0,0	0,0	0,0	0,0	0,0	0,0
3,5	0,4	1,7	6,6	26,3	104	416
4	0,8	3,3	13,2	52,6	209	833
4,5	1,3	5,0	19,8	78,9	314	1250
5	1,7	6,6	26,4	105,2	418	1666
>5	Over-amplification					

Table 4: Voltage / voltage equivalence table, in dynamic mode

Communication:

Using the Configuration interface:

Gain and mode can be changed from a PC using the SDT accessory **FU.RSC.ACC.001**, in a simple way.

-**Download** then **install** the required SDT COMMONSENSE tool (compatible windows) at:

<https://sdtultrasound.com/support/software/>

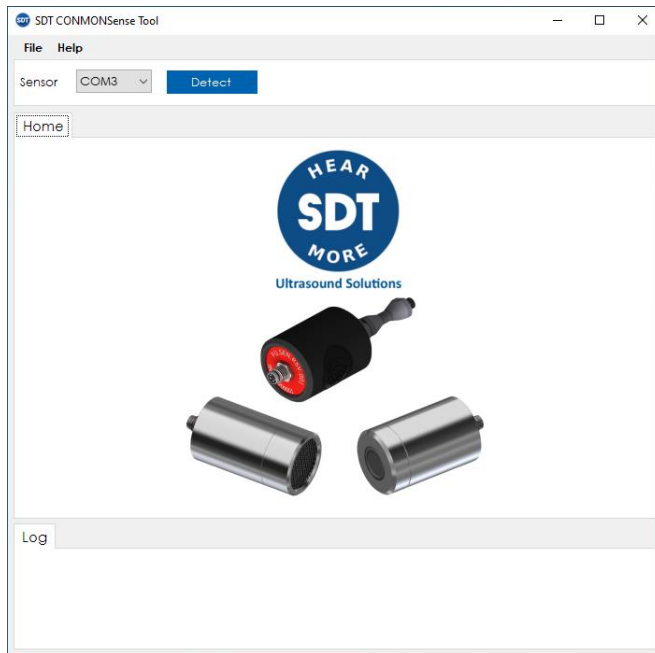

- Connect** the sensor and the PC to the configuration interface using the provided cables.
- Read** or **Write** the sensor settings
- Apply** the new settings in your acquisition system

Digital output mode

Gain and mode can be selected by generating pulses on the communication line.

The default state of the line is +VDD (pulled up internally with a 10 [k Ω] resistor) and a pulse consists of pulling the line down for at least 1 [ms] then releasing the line.

After the first pulse is initiated a 5 [s] internal timer is started. When the 5 [s] timeout occurs, the sensor counts how many pulses it received during this time-lapse:

- 1 pulse: increase the gain by 12 [dB] (has no effect if the gain is already at 60 [dB]);
- 2 pulses: decrease the gain by 12 [dB] (has no effect if the gain is already at 0 [dB]);
- 3 pulses: change the mode (switch between static and dynamic mode);
- 4 pulses: initialize the sensor in dynamic mode with a gain of 60 [dB] (factory reset);

After any modification, data are saved inside a non-volatile memory and are restored on sensor power on.

Example

- Change the output mode (generate 3 pulses under 5 [s]).

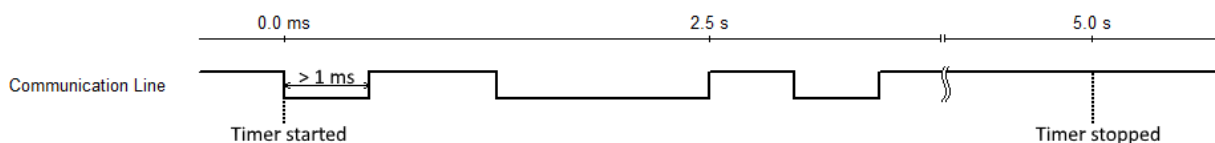

Serial mode

The communication line can also be used for a serial communication allowing advanced features. The protocol used is UART 9600-8-E-1 (9600 bauds, 8 data bits, 1 even parity bit, 1 stop bit). The user can write data to the sensor and read them back:

- 1) The serial communication is initialized by the user by sending the header byte <AAh>.
- 2) The second byte is the device address or the generic address (<00h>). The sensor will only answer to its specific address or to the generic address.
- 3) The third byte is the memory address (see below) that the user wants to write or to read.
- 4) The fourth byte is the operation: <00h> for a write operation; <01h> for a read operation.
- 5)
 - a. During a write, the fifth byte is sent by the user with the data that needs to be written.
 - b. During a read, the fifth byte is sent by the user and contain the one-byte checksum.
- 6)
 - a. During a write, the sixth byte is sent by the user and contain the one-byte checksum.
 - b. During a read, the sixth byte is sent by the sensor containing the value of the memory address.

The one-byte checksum is the LSB (least signification byte) from the addition of all bytes sent.

After any modification, data are saved inside a non-volatile memory and are restored on sensor power on.

Memory address

00	Sensor specific address (R/W)	range 0 to 255
01	Sensor gain (R/W)	range 0 to 60 with a step of 12
02	Sensor mode (R/W)	1 for static mode; 2 for dynamic mode
03	Temperature (R)	8bits integer temperature value
04	Temperature (R)	32bits float temperature value byte 1 (LSB)
05	Temperature (R)	32bits float temperature value byte 2
06	Temperature (R)	32bits float number temperature value byte 3
07	Temperature (R)	32bits float number temperature value byte 4 (MSB)
08	Firmware version (R)	32bits integer firmware version value byte 1 (LSB)
09	Firmware version (R)	32bits integer firmware version value byte 2
10	Firmware version (R)	32bits integer firmware version value byte 3
11	Firmware version (R)	32bits integer firmware version value byte 4 (MSB)

Examples

- a) write a new specific device address, <11h> to the sensor:

User: <AAh 00h 00h 00h 11h BBh>

(Checksum is AAh + 11h = BBh)

- b) Read the sensor gain (assuming the gain is set at 48 [dB] and the device specific address is set to <11h>):

User: <AAh 11h 01h 01h BDh>

Sensor: <30h>

(Checksum is AAh + 11h + 01h + 01h = BDh)

11	CMA 28/02/2023	Harmonization	RGO
10	CMA 08/02/2022	Configuration interface	RGO
09	CMA 26/11/2021	Conversion charts & tables + tests/approvals	CGI
08	CMA 20/04/2021	Max cable length	RGO
07	CMA 10/11/2020	New info in tables + factory reset	RGO
06	CGI 29/10/2020	No commas but dots	RGO
05	RGO 28/10/2020	Modified output equation	CGI
04	RGO 21/10/2020	Added serial number	CGI
03	RGO 20/10/2020	RSV datasheets modified for Vigilant compatibility	CGI
02	RGO 20/10/2020	Modified Serial Communication	CGI
01	RGO 26/08/2020	Original version	CGI
Revision	Writer	Nature of modification	Approved

*The information herein is believed to be accurate to the best of our knowledge.
Due to continuous research and development, specifications are subject to change without prior notice.*